

# TEM 2020

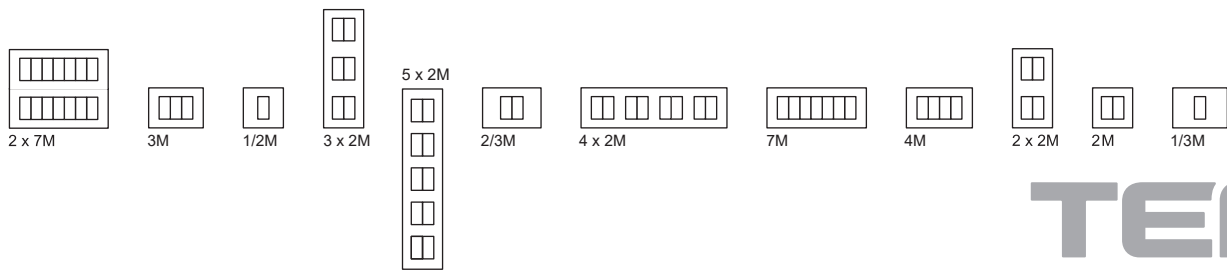

On | Off and everything in between





TEM

# Willkommen bei der Familie $\Pi$ O D U L

## Welcome to the $\Pi$ O D U L family

Für Sie ergänzen und vervollständigen wir die moderne Schalterfamilie Modul für alle Arten von Räumen.

We are expanding and perfecting the modern Modul switch family for all types of rooms.



discovering new insights

wir entdecken neue Einblicke

# MODUL

Designlinien Pure, Line und Soft sind Ausdruck eines modernen, anspruchsvollen und individuellen Lebensstils. Aus der breiten und reichen Palette von Farben, Mustern und Formen können Sie Ihre Schalter und Steckdosen jederzeit einfach an das gewünschte Ambiente und Atmosphäre anpassen.

The Pure, Line and Soft design lines reflect a modern, sophisticated and independent lifestyle. You can choose from a wide and rich selection of colours, patterns and shapes to alter the appearance of your switches and sockets so that they fit the desired atmosphere and mood.

PURE

natürliche Materialien  
natural materials

Holz wood  
Metall metal  
Glas glass

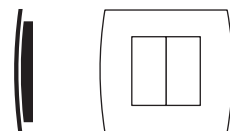

—line—



gerade Linien  
straight lines

—soft—



weiche Linien  
soft lines

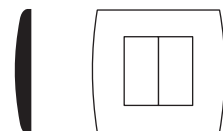
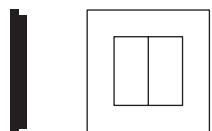

PURE



# herrlicher Aufenthalt wonderful living

Aus reinen, unbefleckten Bildern der neu geborenen Welt entstand das Kapitel Pure. Wir verflochten den Hauch von Naturmotiven mit edlem Geschmack für Linien und verweben darin die Fäden der Spitzentechnologie.

From the cleanliness and purity of a new-born world stems the story of the Pure line. The touch of natural motifs is intertwined with a sophisticated taste for lines and form and interwoven with threads of state-of-the-art technology.

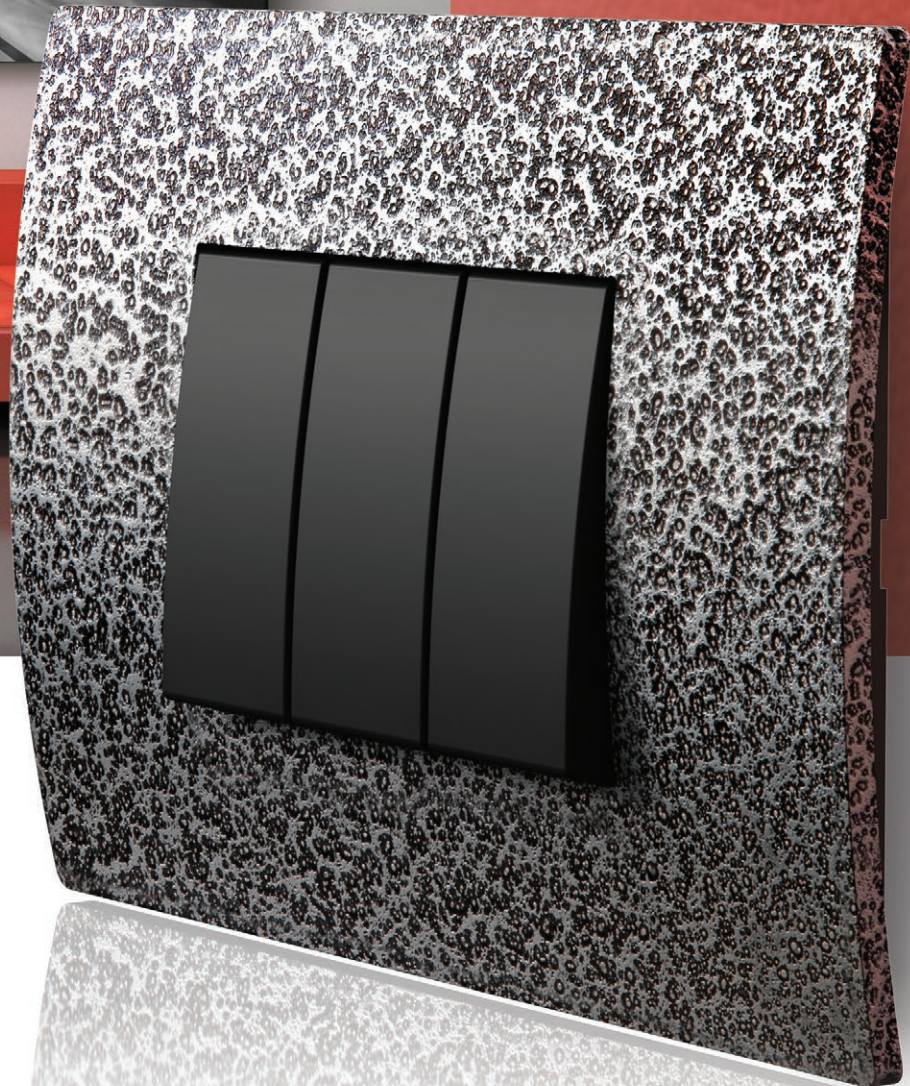

# PURE

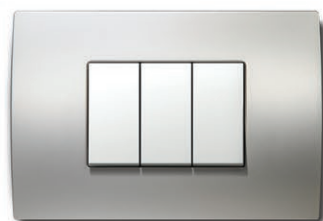
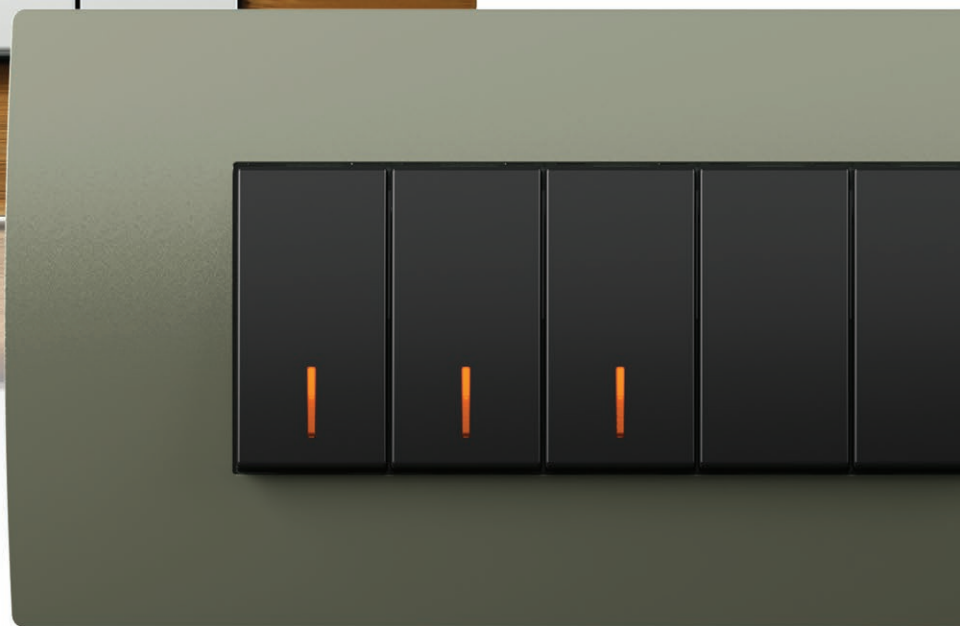





## ein Gefühl der Natur feeling of nature

Die Linie der Schalter PURE zeichnet sich durch natürliche Materialien aus: Metall, Holz, Glas. Einen besonderen Touch verleiht das einzigartige Design. Es ist erkennbar und zugleich dezent. Ausgestrahlt werden Sinnlichkeit, Raffinesse, ein Höchstmaß an Standard und natürlich Reinheit.

The Pure switch line is distinguished by its natural materials: metal, wood and glass. Its unique design gives it a special touch. It is striking yet unobtrusive. It radiates sensuality, sophistication, high standards and, of course, cleanliness.

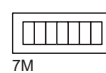
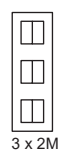
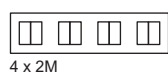

line



# Harmonie der flachen Formen

## harmony of straight lines

Machen Sie sich bereit für die elegante Perfektion der flachen Formen. Erfahren Sie die Brillanz der Flächen, die sanft mit den modernen Elementen Ihrer Räume harmonieren. Zur unverwechselbaren Optik hinzu kommt die Soft Touch-Technologie für angenehmen Schalt- und Bedienkomfort.

Prepare for the elegant perfection of straight shapes. Try brilliant surfaces that gently play with modern elements of your room. We have incorporated "Soft Touch" technology especially for you, turning every touch into a unique experience.



line

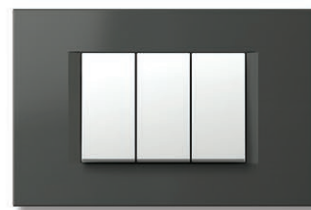
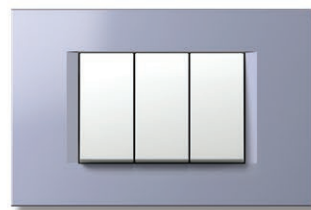
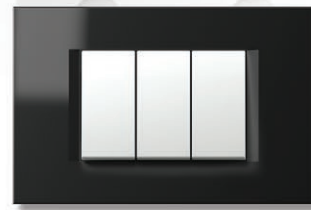
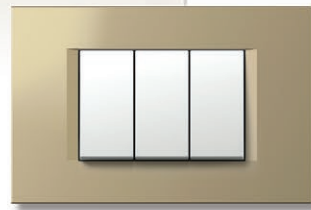
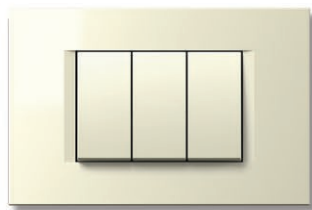
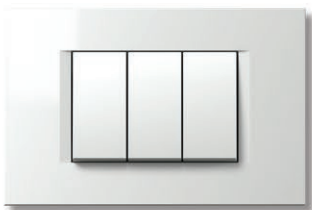
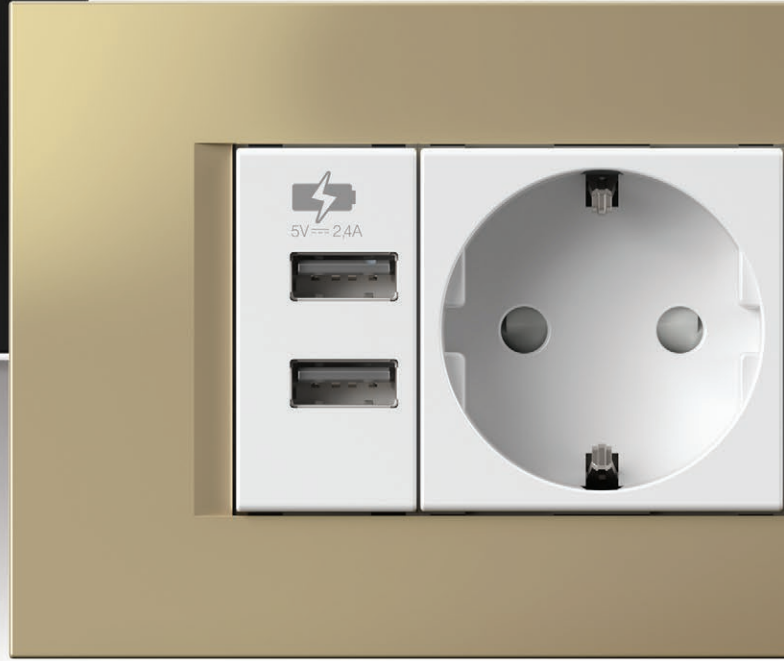

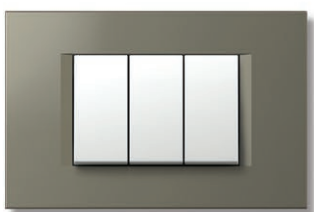
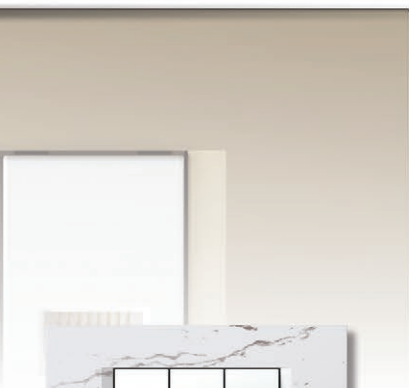

# modernes Design

## modern design

Reine, gerade Linien schaffen ein zeitloses Design.

Ein vollkommenes, flach geformtes dünnes Profil und die Ergonomie von Soft Touch ergeben eine hervorragende Optik aus allen Seiten.

Its straight, smooth lines make for a timeless design.

Its perfectly straight, sleek profile and soft-touch ergonomics give it an amazingly elegant appearance from all angles.

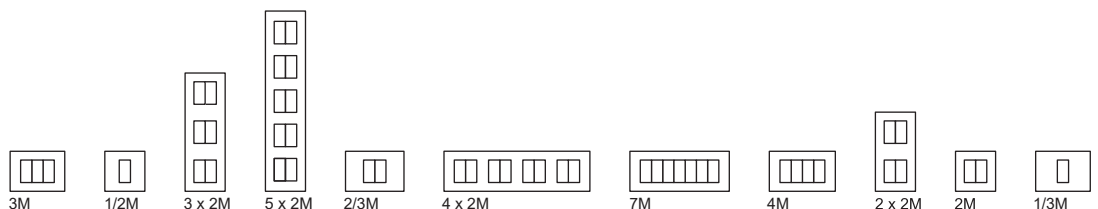

soft



# Geschmeidigkeit für Ihr Zuhause

## softness in your home

Lassen Sie durch die abgerundeten Formen und weichen Übergängen Geschmeidigkeit in Ihr Zuhause bringen.

Let the rounded shapes and soft transitions bring softness into your home.



soft

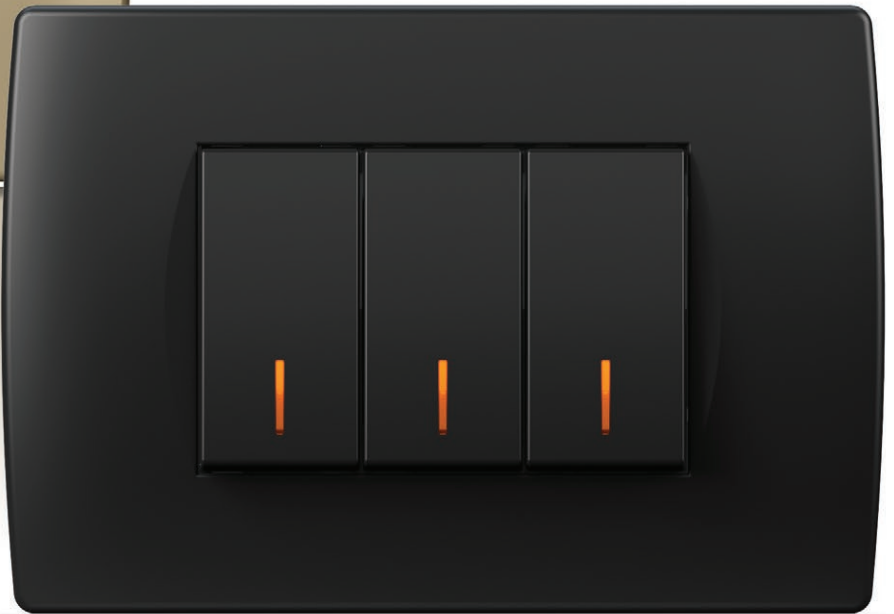





# Wärme des eigenen Heims a warm home

Die Perfektion der weichen Formen ist durch subtile Auswahl von Farben und besonderen Beschichtungen ergänzt, die Sie bei jeder Berührung wahrnehmen.

Perfectly soft shapes rounded off by a subtle selection of colours and special coatings for a special touch.

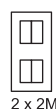
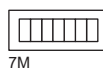
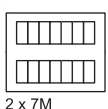



# anthrazit

## anthracite

Wir ergänzen unser Sortiment um zwei aufregende Farben – ANTHRAZIT und TITAN. Beide werden dem anspruchsvollen Stilgefühl unserer Kunden bewusst und runden die Einzelheiten ihrer Räume individuell ab. So fügen sich unsere Produkte perfekt in die Farbharmonie Ihrer modernen Einrichtung.

We are adding two colour experiences to our range – ANTHRACITE and TITANIUM. They both satisfy our customer's sophisticated sense of style and complement the details of spaces according to their wishes. Now you can upgrade your modern apartment in harmony.

# trendfarben

trendy colours



titan  
titanium

# multifunktionalität

## multifunctionality



# ästhetik

## aesthetics

Wir haben größere Deckplatten entworfen, die es Ihnen ermöglichen, verschiedene Funktionen von einem Ort aus zu steuern. Diese Platten sind in den Sortimenten LINE, SOFT und PURE erhältlich. Sie wurden aus Naturmaterialien hergestellt und greifen verschiedene Designelemente auf, die ihre unvergleichliche Ästhetik unterstreichen.

We have created larger cover plates for you that allow you to manage multiple functions from one spot. They are available in the LINE, SOFT and PURE design ranges. The cover plates, which are made from natural materials, utilise the repetition of design elements to elevate them to a high aesthetic level.



# der Universaldimmer

universal dimmer

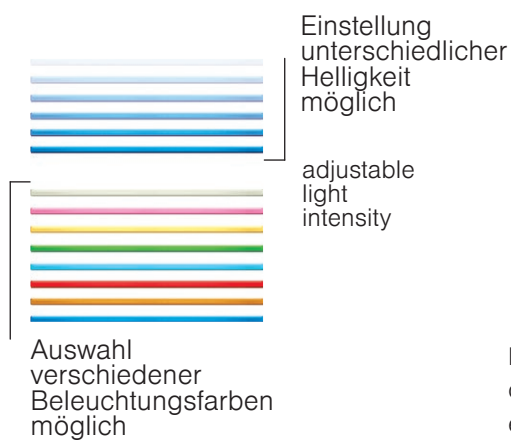
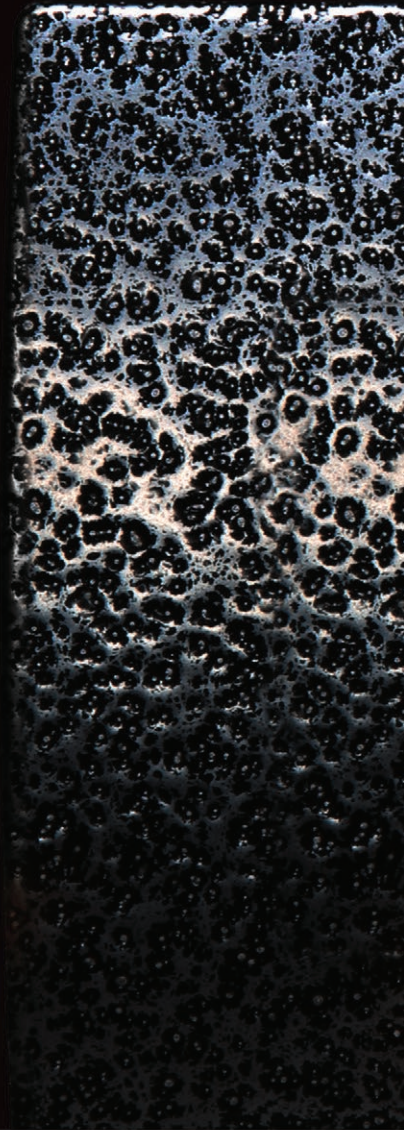

choosing illumination colour

In Dunkelheit wird Touch zur eleganten Ambientleuchte zur Markierung der Schalterposition und sanften Beleuchtung des Raumes. Sie können einen der acht verschiedenen Farbtöne der sanften Beleuchtung auswählen und die Helligkeit beliebig Ihrer Stimmung anpassen.

In the dark Touch becomes a tender soft ambient light. It marks the spot of a switch and gently illuminates a place. You can choose among eight different colours of tender light and adapt its brightness according to your mood.

TOUCH®



## ein noch nie da gewesenes Licht light as never seen before

Gedämpftes Licht schafft eine Atmosphäre des Friedens, der Sinnlichkeit und der Romantik. Es ist ein Warenzeichen von romantischen Cafés und ruhigen spätabendlichen Stunden zu Hause oder am Arbeitsplatz. Die verzögerte sanfte Einschaltung verlängert nicht nur die Lebensdauer der Leuchtmittel, auch wird die Dunkelheit viel angenehmer und langsamer durch das Licht ersetzt. Durch Touch kann das Licht unabhängig vom Lampen- und Leuchtmitteltyp überall verdunkelt werden.

A dimmed light makes peaceful, sensual and romantic atmosphere. It is a trade mark of romantic places and quiet late evening hours spent at home or at work. Switching is soft and extended. It does not only prolong the lamp life expectancy, but also changes darkness into light in a slower and much more pleasant way. Touch enables you to dim the light anywhere, regardless of the type of lamps.







## Alles an einer Stelle

everything in one place

Ihr Haus ist ein Lebenszentrum geworden. Die verschiedensten Geräte verlangen eine Menge von Anschlüssen und Steckdosen. Bauen Sie sich ein eigenes Multimediazentrum mit Möglichkeiten zum Anschluss und Bedienung mehrerer verschiedener Komponenten an einer Stelle.

Your house is the centre of your life. The multitude of devices you use requires a number of connectors and sockets. Create your own multimedia centre, one that will allow you to connect and use a multiple number of different components in one place.





# innovativer Temperaturregler

## innovative temperature controller

Sorgen Sie für Ihr Komfort und regeln Sie die Temperatur in Ihren Wohn- und Arbeitsräumen mit einem intelligenten Thermostat. Sie können sowohl Heiz- als auch Kühlanlagen steuern und haben auch die Möglichkeit einer ökonomischen Betriebsart.

Make yourself comfortable by controlling the temperature in your living and working rooms during all seasons with a smart thermostat. It allows you to control heating and cooling devices and features an eco-function.

# der Raumkomfort

comfort in your room



# Bedienkomfort

convenience of use



## TOUCHLESS – ohne Berührung

Berührungslose Schalter ermöglichen einen modernen Lebensstil – die Beleuchtung kann ein- und ausschaltet werden, ohne die Schalter zu berühren. Diese Möglichkeit ist sehr nützlich, wenn Sie volle oder schmutzige Hände haben, da Sie die Beleuchtung berührungslos einschalten können.

The touchless switch allows you to enjoy a modern lifestyle, enabling the turning on and off of your lights, without the need for physical interaction. This option is very useful when you find yourself with your hands full, or dirty, as you can achieve the desired lighting without undue fuss.



# moderne Beleuchtung

modern illumination





# 3D-Lampe

## 3D lamp

Das schnelle Tempo des Lebens bringt eine Menge an Informationen. Die 3D-Farblampe ist eine elegante Lösung für die Kennzeichnung, Lenkung und Kommunikation. Die Grafik erstellen wir nach Ihren Wunsch.

The rapid pace of life means you are constantly being bombarded with a plenty of information. 3D colour lamp provide an elegant solution for information and direction signs. We can make graphics according to your wishes.



# BIOPASS - Entriegeln ohne Schlüssel

## BIOPASS – keyless unlocking

BIOPASS ist eine neue Schaltergeneration für das Entriegeln ohne Schlüssel. Es vereint die fortschrittliche Fingerabdruckerkennungstechnologie und schnelles Öffnen der Haustür.

Legen Sie einfach Ihren Finger auf den Biopass-Schalter und die Tür zu Ihrem Haus oder Büro öffnet sich. So einfach und so sehr sicher. Die Bedienung erfolgt einfach über die mobile App.

BIOPASS is the new generation of switches for keyless unlocking. It combines advanced fingerprint recognition technology with quick front door opening.

Simply put your finger on the Biopass switch and the doors to your home or office will open. It is so easy to use and incredibly secure. You can manage it effortlessly via the mobile app.



# erhöhte Sicherheit

improved security



# Individualität

individuality



## bauen Sie sich Ihre eigenen

make it your own

Seien Sie anders. Gönnen Sie sich Schalter nach Ihren Maß. Wählen Sie zwischen den verschiedenen Farben der Rahmen oder lassen Sie uns Ihre Schalter durch beliebige Grafiken und Beschriftungen dekorieren. Wählen Sie eine Farbe der Beleuchtung, die zu Ihrem Ambiente passt.

Be different. Make a switch according to your taste. You can choose between different frame colours and we can decorate them for you with custom graphics or signs. Choose a illumination colour that suits the ambience of your room.



geeignet für öffentlichen Einsatz  
suitable for public use



## Qualität und Haltbarkeit quality and durability

Hochwertige und haltbare Materialien garantieren eine lange Lebensdauer der modularen Schalter und Steckdosen MODUL. Das System eignet sich deshalb für die Installation und den unbeschwerten Einsatz in öffentlichen Gebäuden, Geschäftsgebäuden, Ferienunterkünften, Einkaufszentren, Schulen und Sportstätten. Es kann sowohl an moderne Architektur als auch an klassische Interieur angepasst werden.

Quality and durable materials ensure the long lifetime of the MODUL modular switches and sockets. The system is suitable for mounting and carefree use in public facilities, business premises, tourist accommodation, shopping centres, schools and sports facilities. It fits perfectly in both modern architecture and classical interiors.





# leistungsstarke USB-Ladegeräte powerful USB chargers

Die leistungsstarken USB-Ladegeräte Modul ermöglichen schnelles und einfaches Aufladen von Smartphones, Tablets und anderen elektronischen Geräten über einen Standard-USB-Anschluss. Erhältlich in Größe 1M und 2M. Ideal sowohl für private als auch für öffentliche Räume.

The powerful Modul USB chargers enable the fast and simple charging of your smartphones, tablets and other electronic devices via a standard USB connection. They are available in 1M and 2M sizes and are perfect for use in private and public rooms.

# schnelles Aufladen

fast charging

39



# modernes Arbeitsumfeld

a modern working environment







## ästhetische Alu Brüstungskanäle aesthetic aluminium trunkings

Sorgen Sie für Ordnung in Büro-, Schul- und Arbeitsräumen. So können Sie sichtbare Kabel und plumpe Verlängerungen loswerden. Elegante Alu-Brüstungskanäle in modernem Design bieten viel Platz für die Elektroinstallation. Schalter, Steckdosen und Kommunikationsverbindungen sind schnell erreichbar und verfügbar, wo Sie diese benötigen. Sie können diese einfach ändern oder später neue hinzufügen. Schaffen Sie ein funktionales Umfeld.

Organise your office, school and work areas. Forget visible cables and unpractical extensions. The elegant and modern aluminium trunkings offer plenty of space for electrical installations. Switches, sockets and communication elements are easily accessible and available in the right place to be used. They can be easily adapted or upgraded. Arrange a pleasant and functional environment for yourself.

# modular modularity

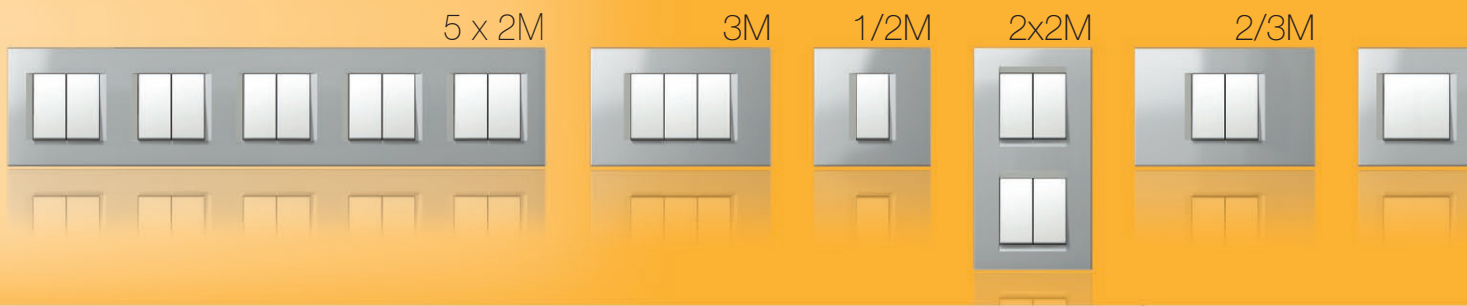

Wir haben für ein ganzheitliches System gesorgt. Sie finden hier alle Elemente für jede beliebige Zusammensetzung. Das System besteht aus Grundelementen – Modulen, die Sie horizontal oder vertikal untereinander kombinieren können.

We have designed a comprehensive system that features a variety of elements, allowing you to create any configuration you wish. The basic elements of the system are modular and can be combined horizontally or vertically.



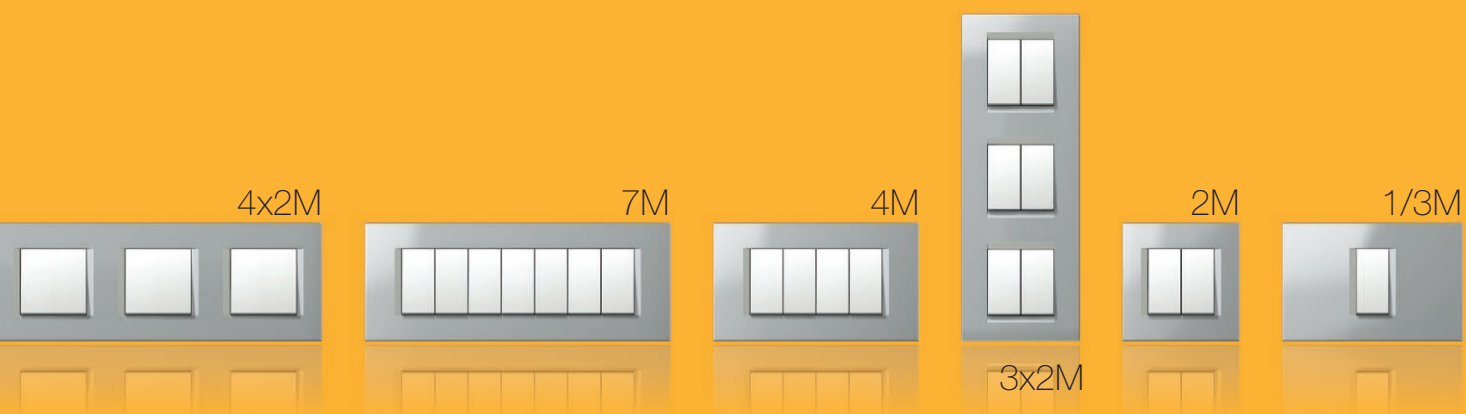

$$1M = \text{[rectangle]}$$

$$2M = \text{[rectangle]} \text{ [rectangle]} = \text{[square]}$$

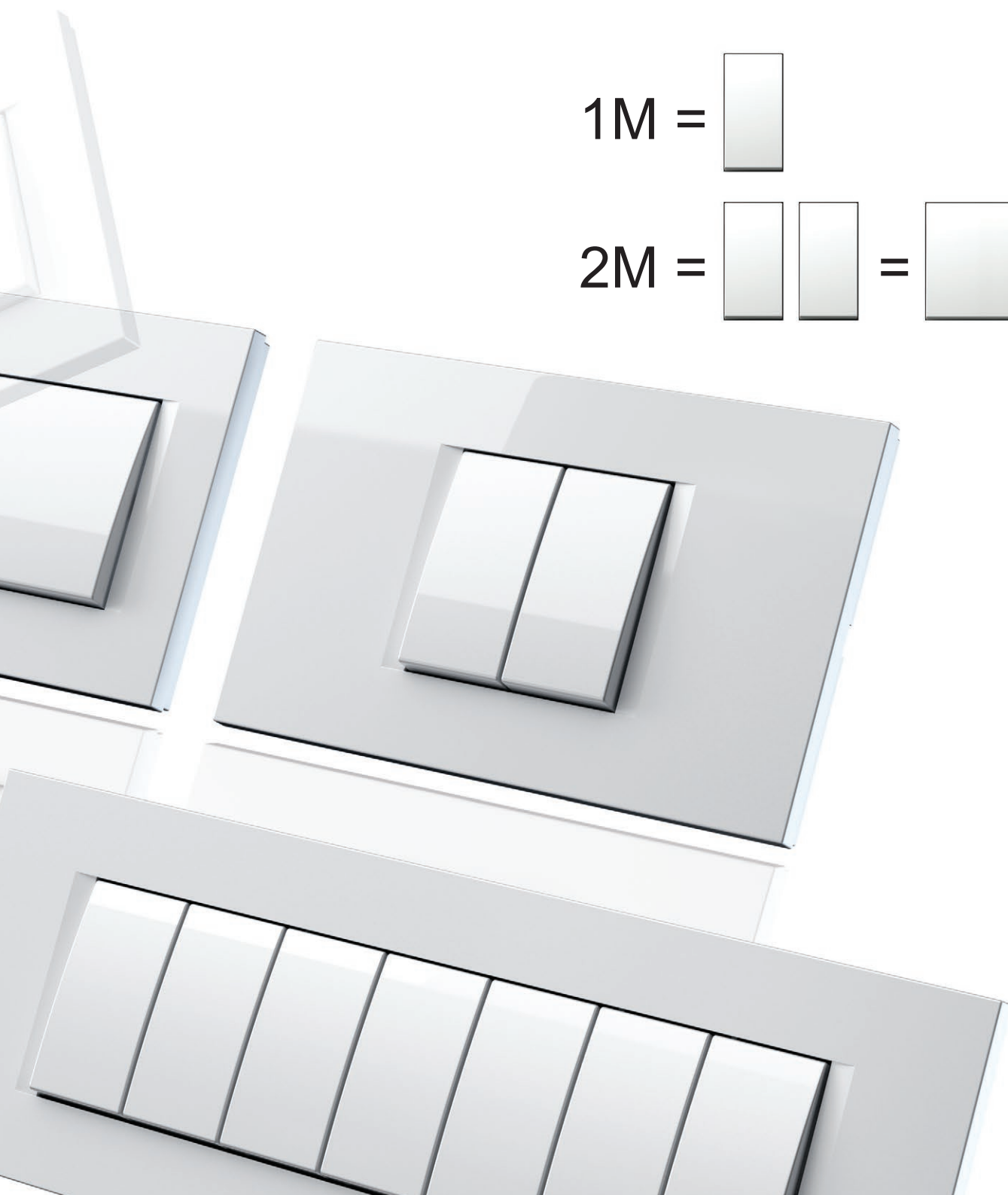

# universell

universality

Das System zeichnet sich durch die vollkommene Auswahl an Elementen und durch einen einfachen Einbau aus. Ein Set von Schaltern kann auf verschiedenste Weisen in den Raum eingefügt werden, sei es in einer runden oder rechteckigen Dose, selbstständig oder im Satz.

The system features a comprehensive selection of elements and is easy to install. Switch sets can be positioned in many different ways, regardless of whether the box is round or rectangular, individual or serial.



[modulmanager.tem.si](http://modulmanager.tem.si)

Nutzen Sie den ModulManager, der Ihnen hilft, beliebige Kombinationen zusammenzusetzen.

Try out the "ModulManager" tool, which will help you put together any combination you want.



## Lösungen für 4 Schalter

solutions for 4 switches



# MODUL MANAGER

einfach und schnell / easy and fast





# Der Konfigurator für Schalter und Steckdosen

## configurator of switches and sockets

Der ModulManager ermöglicht es Ihnen eine vollständige und schnelle Auflistung der benötigten Schalter auf der Baustelle oder komfortabel bei Ihnen zu Hause zu erstellen. Hier haben Sie eine einzigartige Möglichkeit für eine praktische und schnelle Beschaffung die Sie durch kombinieren der Farben der Schalter und Formen der Rahmen an Ihren Raum oder Wünsche der Kunden anpassen können. Testen Sie uns, Sie brauchen dazu nur ein Smartphone, Tablet oder Computer und [modulmanager.tem.si](http://modulmanager.tem.si).

The Modul Manager allows you to perform a complete and quick inventory of switches from the building site itself or from the comfort of your own home. We have prepared a unique ordering method, which is both practical and quick. You can select the colours of the switches, as well as the shape of the frames, meaning you can tailor them to your space or the client's demands. Why not try us out? All you need is a smartphone, a tablet, or a computer and <http://modulmanager.tem.si>.

# funktionell functionality

Modul ist konzipiert für alle, die ein durchdacht gestaltetes Produkt zu schätzen wissen. Das System benötigt weniger Platz, da im einen Rahmen eine beliebige Kombination von Funktionselementen zusammengesetzt werden kann. Damit ist es für Neubauten genauso geeignet wie für Umbauarbeiten und Adaptionen.

The Modul was developed for those who can appreciate a thoughtfully designed product. The system takes up less space, as any combination of function elements can be fitted inside the same cover plate. It is suitable for new, as well as renovated buildings.



Modul Soft auch in der antibakteriellen Ausführung AW.  
The Modul Soft is also available in an antibacterial solution AW.





# einfach simplicity

Die Funktionselemente werden einfach an dem Träger befestigt. Für Sie entwickelten wir die „Klick-Ein-Klick-Aus-Lösung“, die wesentlich zur Verkürzung der Montagezeit beiträgt. Die Anschlusskontakte sind von der Vorderseite leicht erreichbar.

The function elements are easily fitted inside the mounting frame. The “klik-in, klik-out” solution we have developed for you will reduce installation time. The connection contacts are easily accessible from the front.

line  
soft  
PURE

klik-in, klik-out

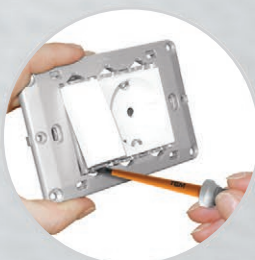
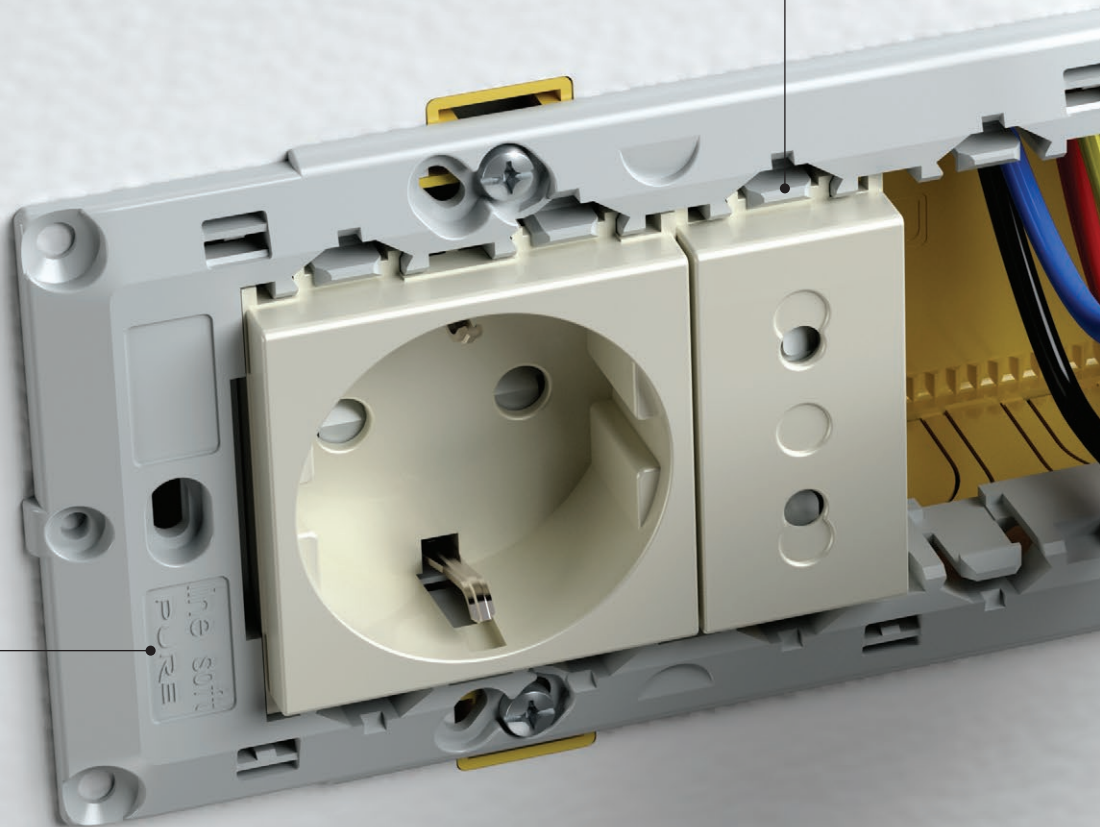

„Klick-Aus“ – einfach und schnell,  
ohne zu schrauben.

“klik-out” - simple and quick,  
no screws necessary.

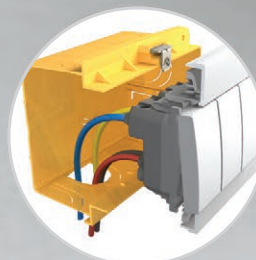

In rechteckigen Dosen ist mehr  
Platz für Anschlussleitungen.

Rectangular boxes have more  
space for connection wires.

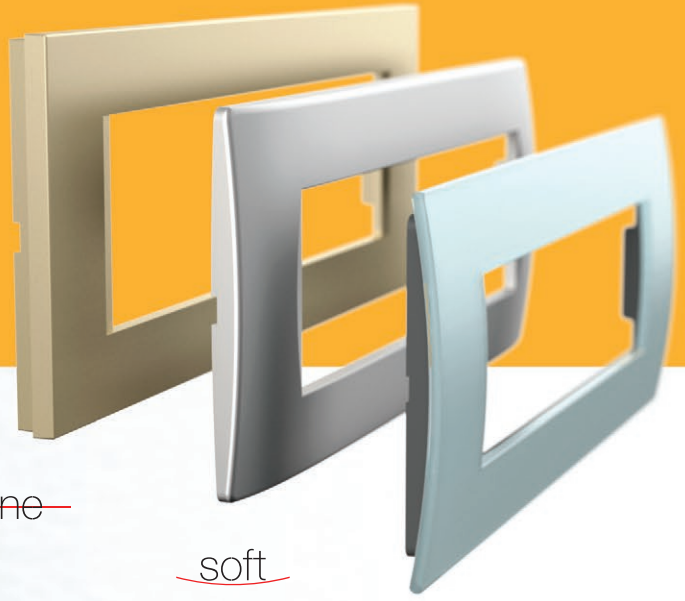
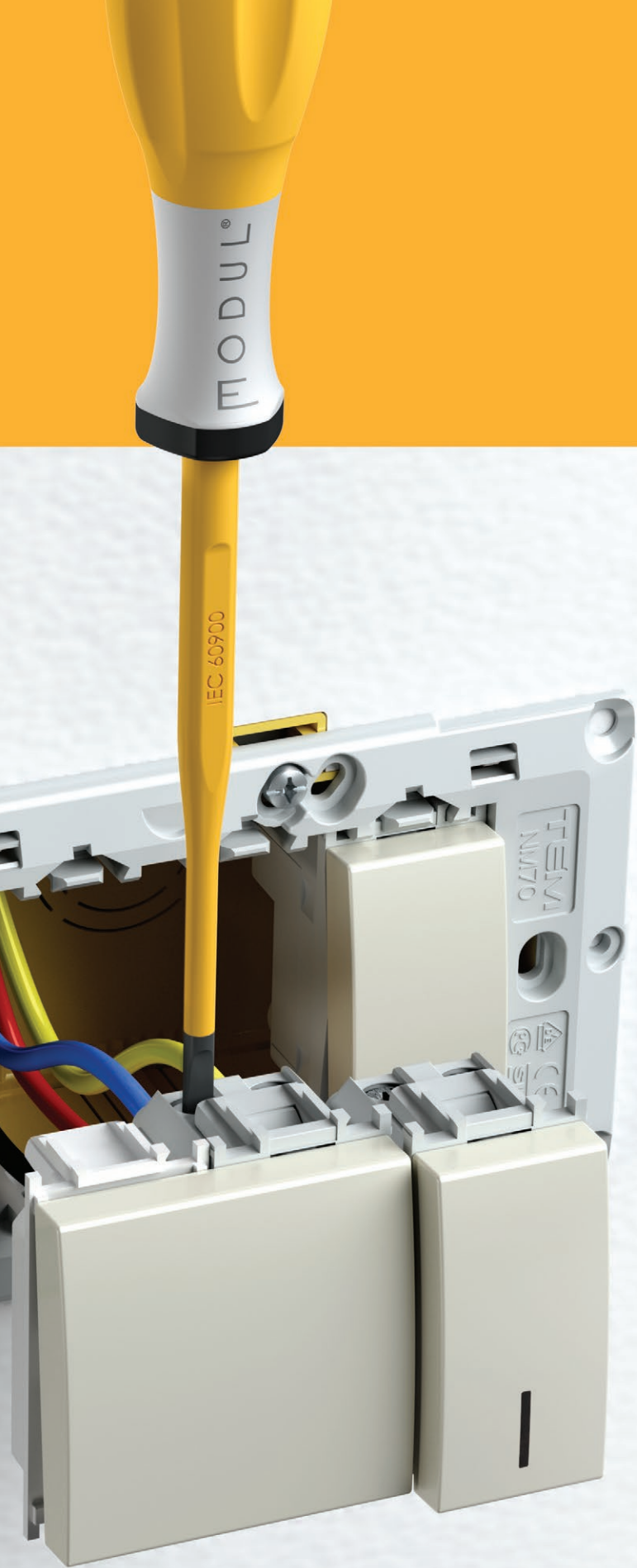

~~line~~

soft

PURE

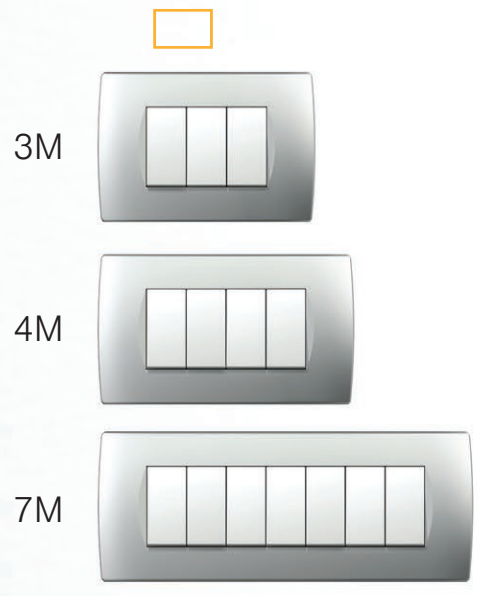

# zusammensetzbar combinability

Modul bietet Ihnen viele Möglichkeiten auch durch die Verwendung von Runddosen. Sie können horizontal, vertikal, selbstständig oder im Satz kombinieren. Der Metallträger gewährleistet eine hervorragende Stabilität auch beim Grobeinsatz und ist für alle dekorative Rahmen geeignet.

The Modul enables a many possibilities even with round boxes. You can combine them horizontally or vertically, individually or in groups. The metal mounting frame ensures excellent stability even with rough use and is suitable for any decorative cover plates.

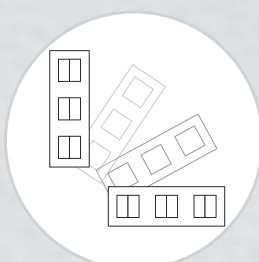
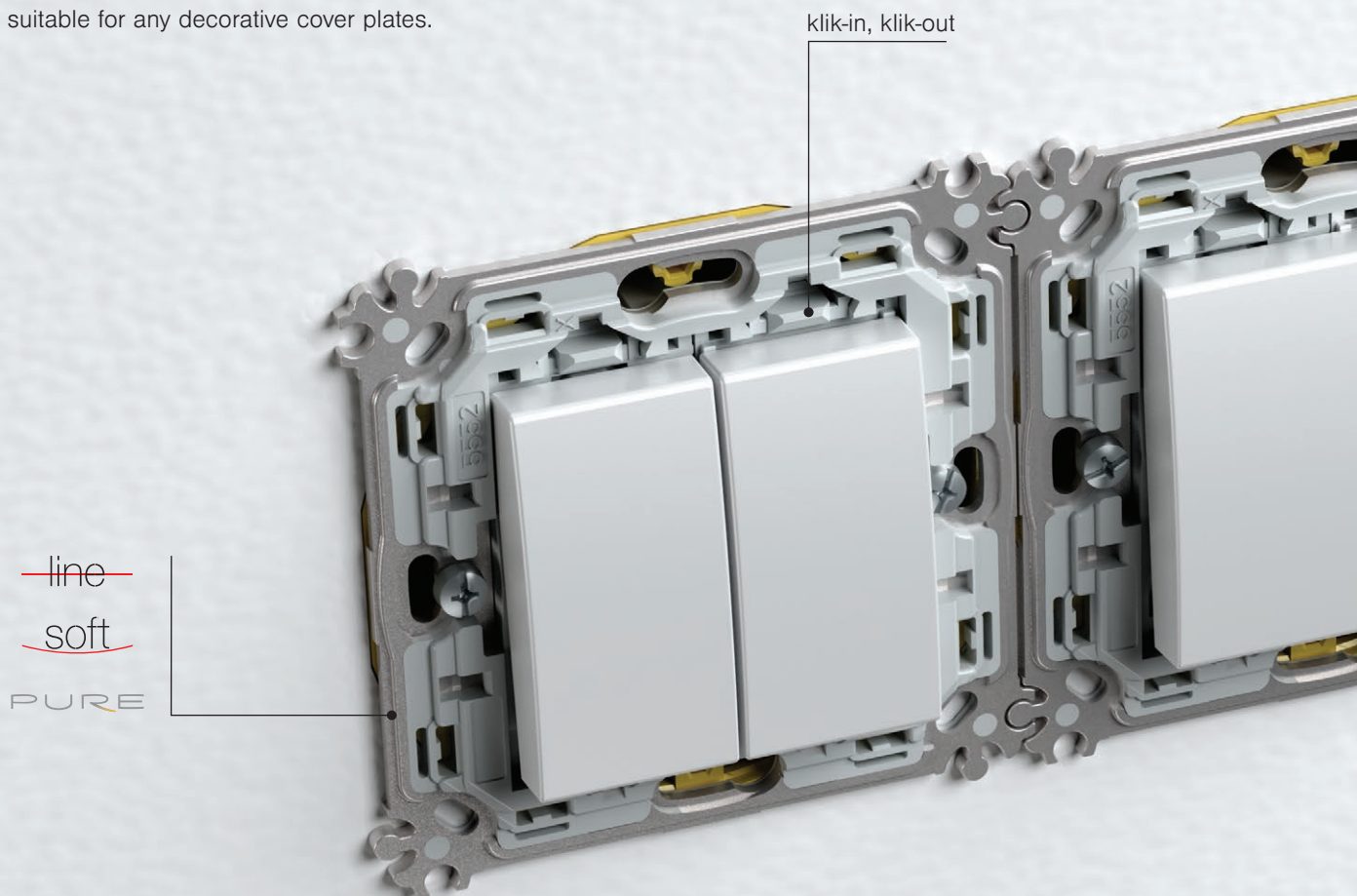

Der gleiche Rahmen kann sowohl horizontal als auch vertikal eingesetzt werden.

The same cover plate can be positioned horizontally or vertically.

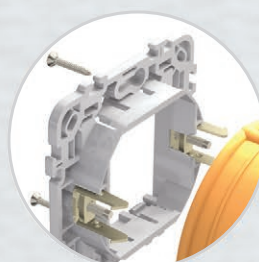

Die Montageträger sind zur Schrauben- oder Krallenbefestigung geeignet.

Mounting frames can be fixed with screws or claws.

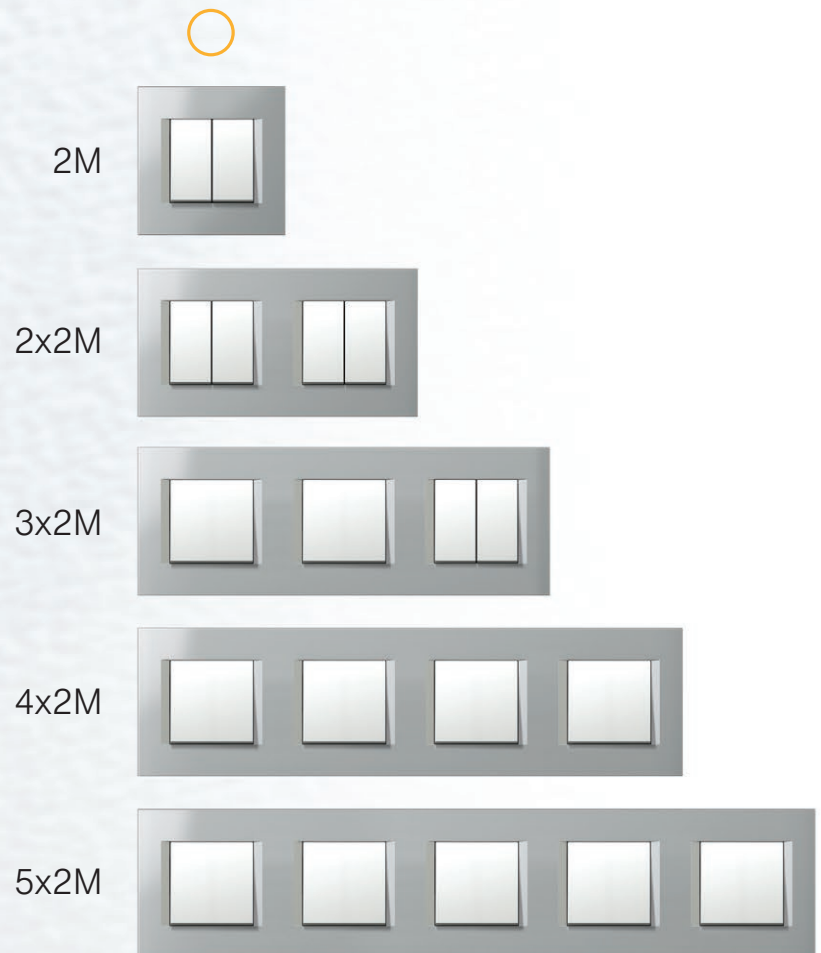
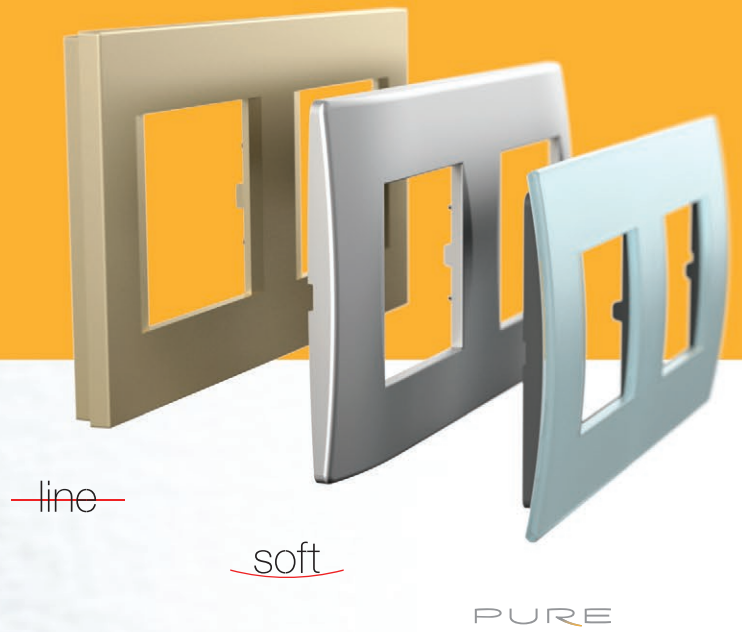

Montageträger in der Größe 2M können durch einfache Umschaltung zu größeren Gruppen zusammenverbunden werden.  
2M mounting frames are easily joined into groups.

# universell

universality

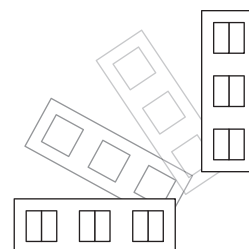
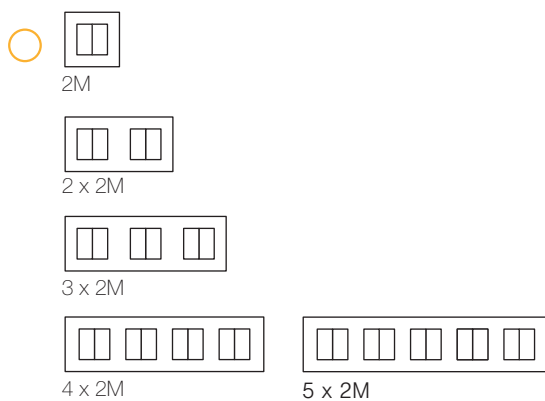
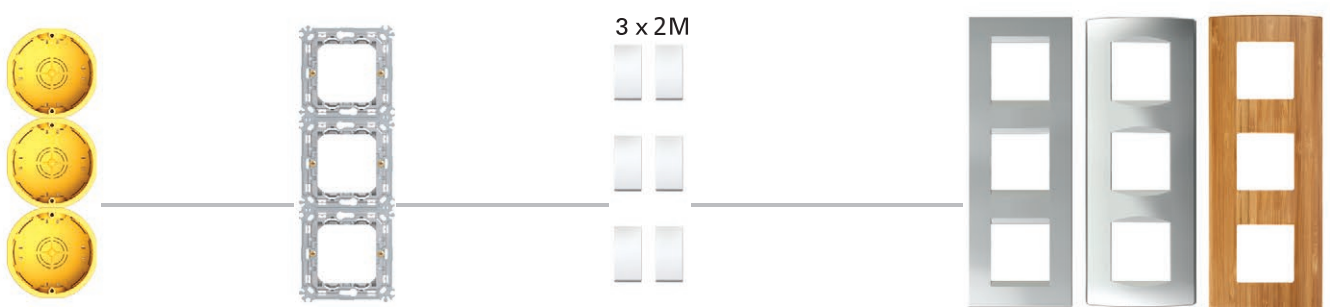
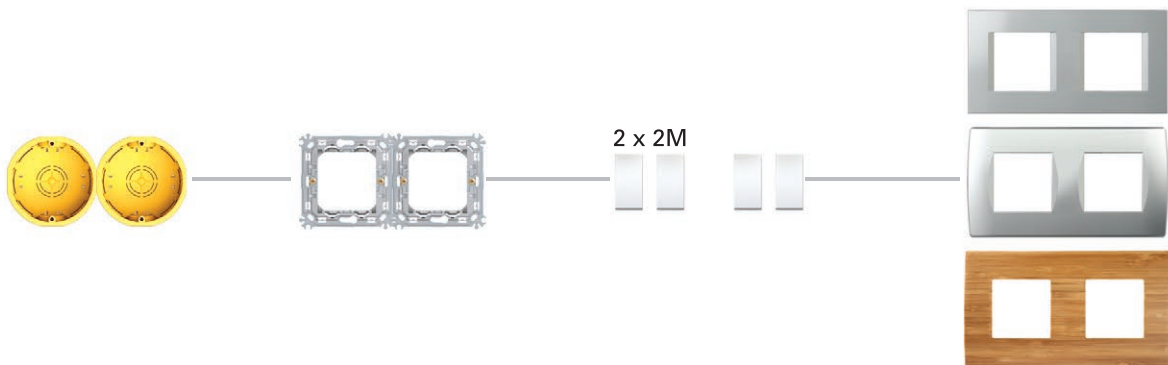
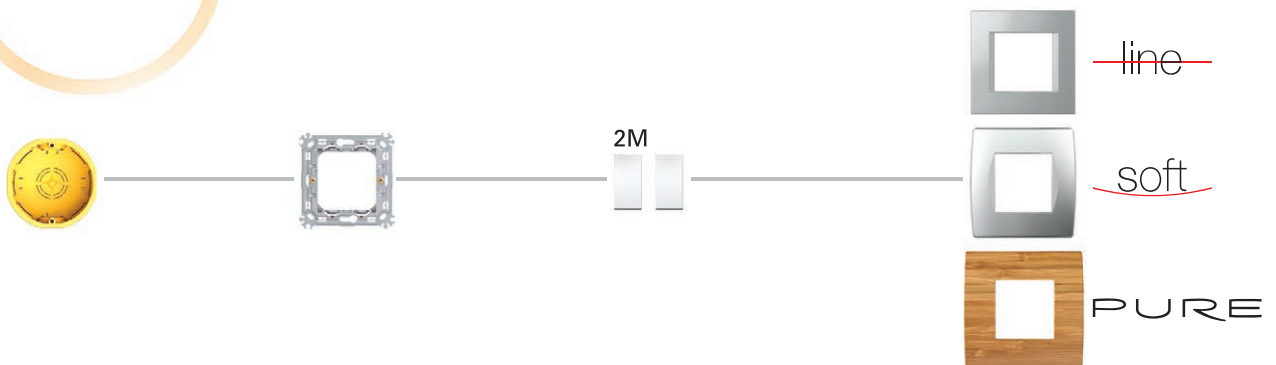

The system is universal and can be fitted in both round and rectangular boxes.

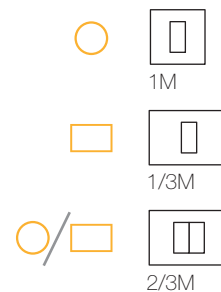
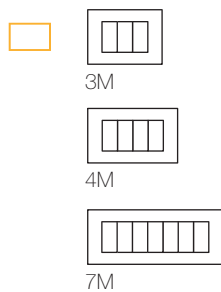
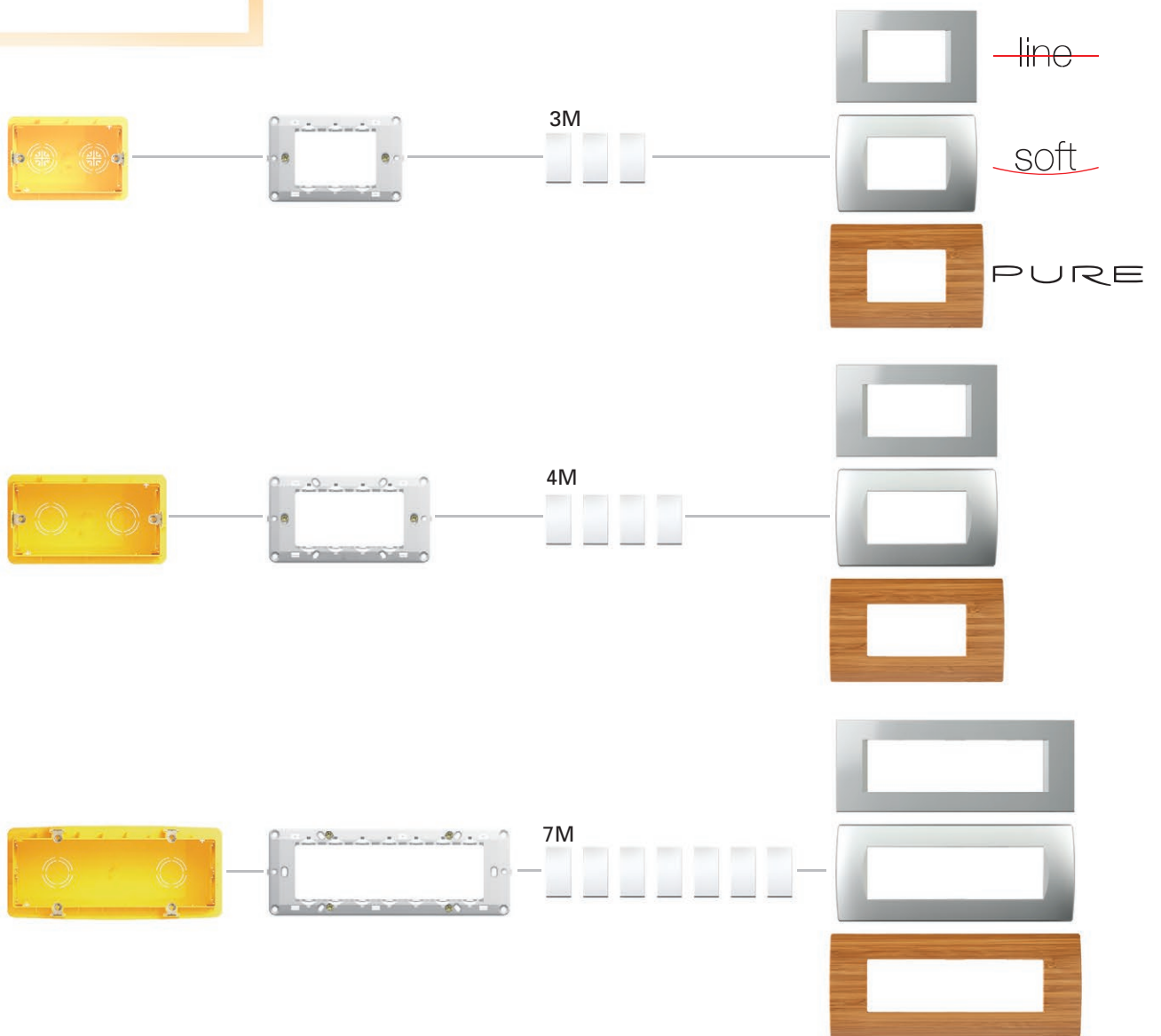
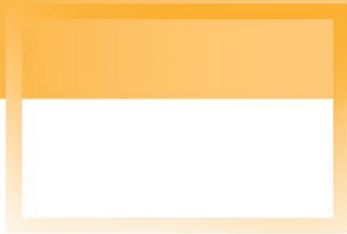

# Funktionselemente

function elements

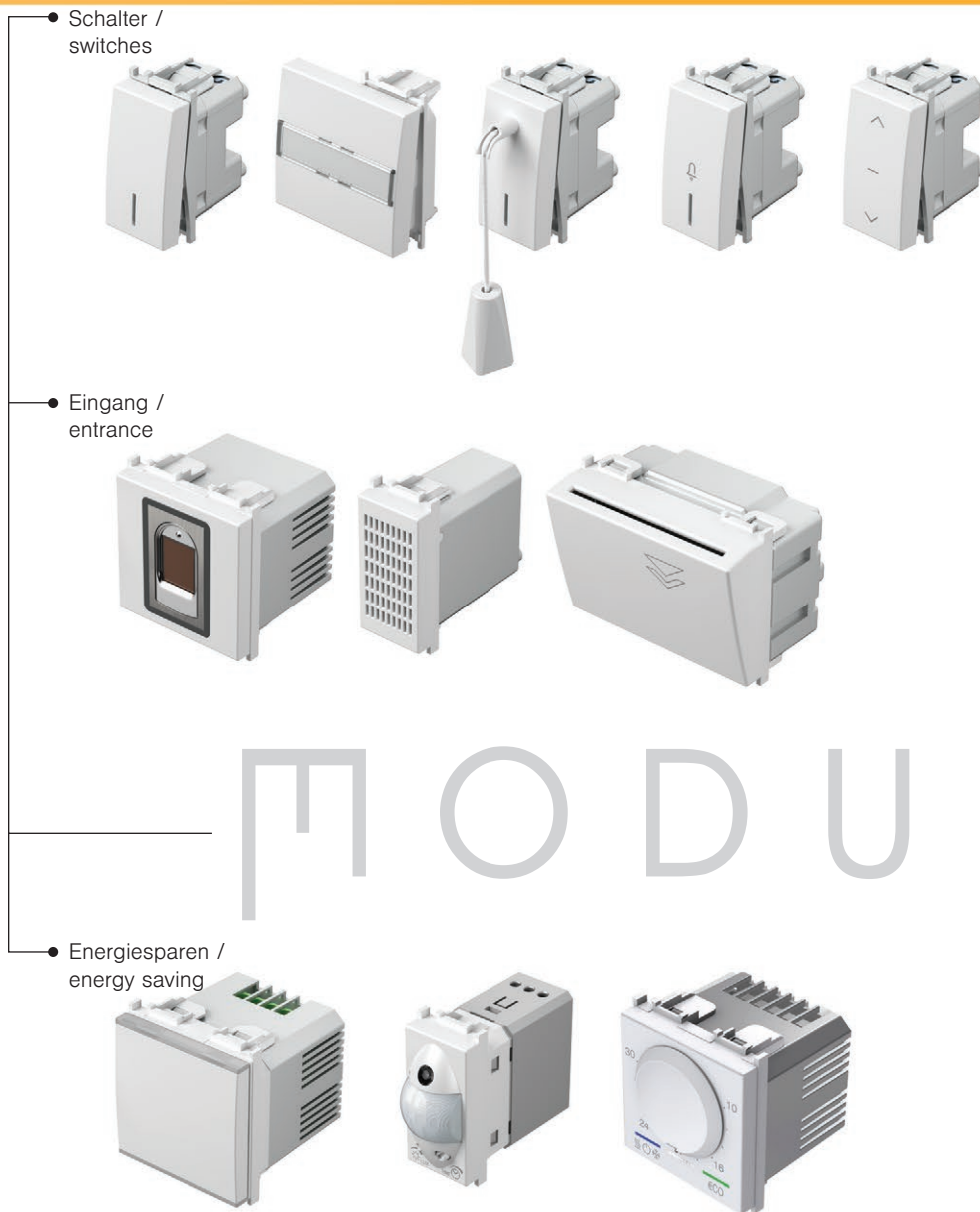

Zuverlässiger und einfacher Anschluss der Leiter in verschiedenen Durchmesser.  
Reliable connection even when different size of wires are used.



Lange Lebensdauer und Konformität mit aktuellen Normen.  
Long-life of switches and adequacy to the international standards.



Wir haben für eine breite Palette an Funktionselementen in der Modul-Familie gesorgt. Dadurch können Sie sowohl einfache als auch anspruchsvolle Installationen planen.

We have designed a wide selection of function element for the Modul family. You can use them to design both simple and complex installations.



• Steckdosen / sockets

• Vergnügen / entertainment

• Beleuchtung / illumination



Alle Steckdosen verfügen über einen integrierten Berührungsschutz (Kinderschutz).

All the sockets are equipped with a safety shutters assuring the protection to live contacts.



**16 AX**  
Kontakte

Silberne Kontakte garantieren zuverlässiges Schalten.

The switch is highly reliable via its silver rivets contacts.

# Einzigartiges Anwendungsspektrum

unique range of usability

Modul Soft AW  
antibakterielle Ausführung /  
antibacterial solution



# MODUL

CUBO IP20

Aufputzgehäuse  
surface mounted boxes



CUBO IP55

Aufputzgehäuse  
surface mounted boxes



IP44

Unterputzgehäuse  
flush mounted



Geht es um eine Ausstattung für Zuhause, Büro oder Werkstatt?  
Modul ist für Wohn- und Arbeitsräume in privaten und öffentlichen  
Gebäuden geeignet. Einzigartig daran ist, dass Sie die Schalter und  
Steckdosen dort einbauen können, wo Sie diese benötigen.

Are you furnishing your home, office or workshop? The Modul is  
suitable for living as well as working spaces and both private and public  
buildings. It is unique in that the switches and sockets can be fitted  
wherever they are needed.

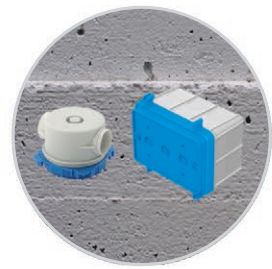
**D**Ziegelwand  
brick**H**Hohlwand  
hollow wall**B**Betonwand  
concrete

• Funktionselemente /  
function elements

Schalter / switches  
Steckdosen / sockets  
Kommunikation / communications  
Sensoren / sensors  
Regler / regulators  
Beleuchtung / illuminations

**MA**Brüstungskanäle  
trunking systems**MO**Verteilerkasten  
distribution boards**MT**Bodendosen  
floor boxes

# Unterputzlösungen

flush mounted solutions

Ziegelwand / brick

Modul kann in alle Wandarten eingebaut werden, sei dies eine klassische, Trockenbau- oder eine Betonwand.  
Der Einbau ist einfach und bietet Ihnen die Möglichkeit des Zusammenbau von runden oder rechteckigen Dosen in beliebigen Abständen.  
Die verwendeten Materialien werden nach hohen Normen geprüft.

The Modul is suitable for all wall types and can be used in conventional, hollow wall or concrete constructions. It is easy to install and enables you to combine rectangular or round boxes at the proper distances. The materials used are compliant with high standards.



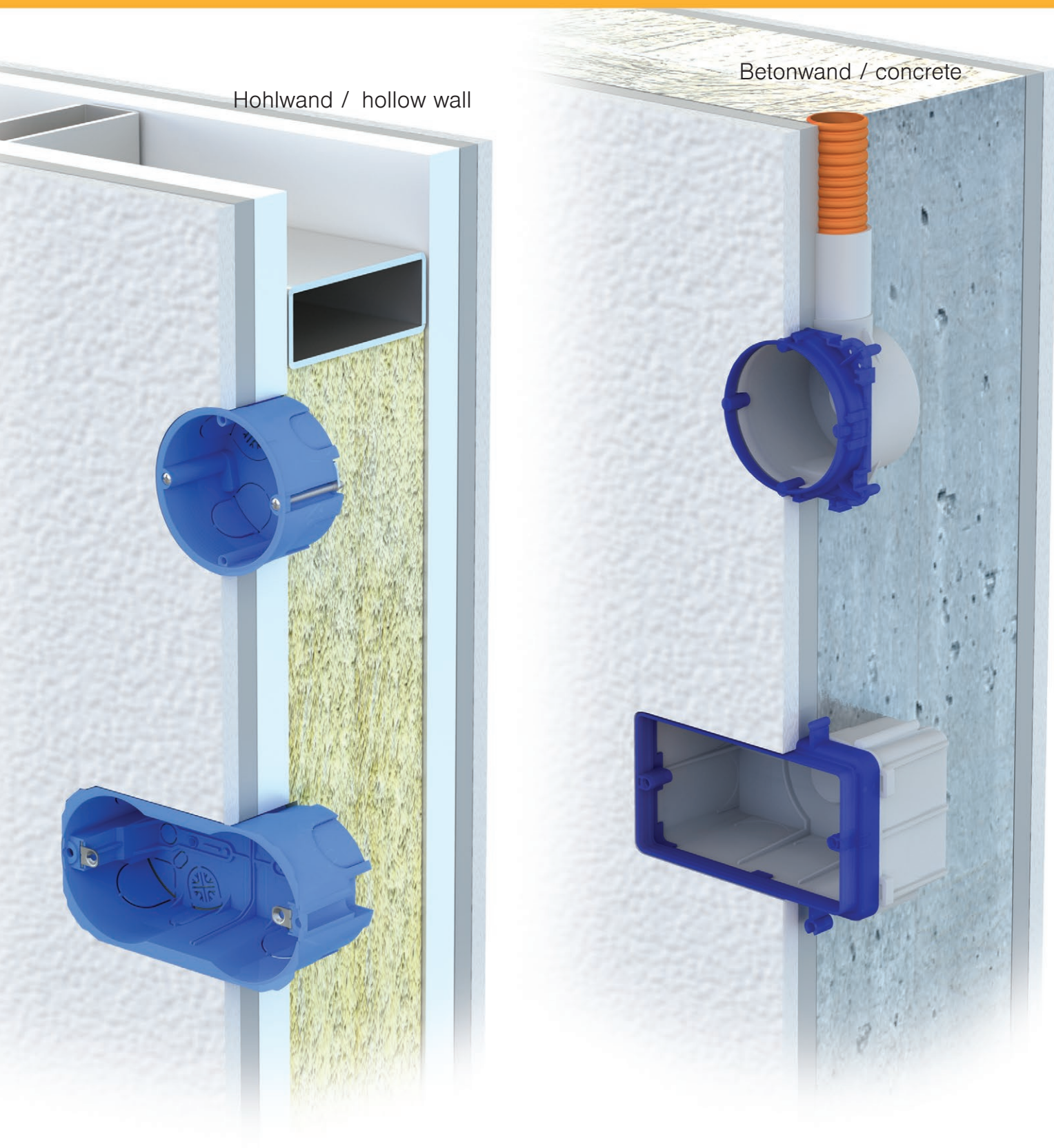

# Weitere Lösungen

other solutions

IP44  
Unterputzgehäuse  
flush mounted



CUBO IP20  
Aufputzgehäuse  
surface mounted boxes

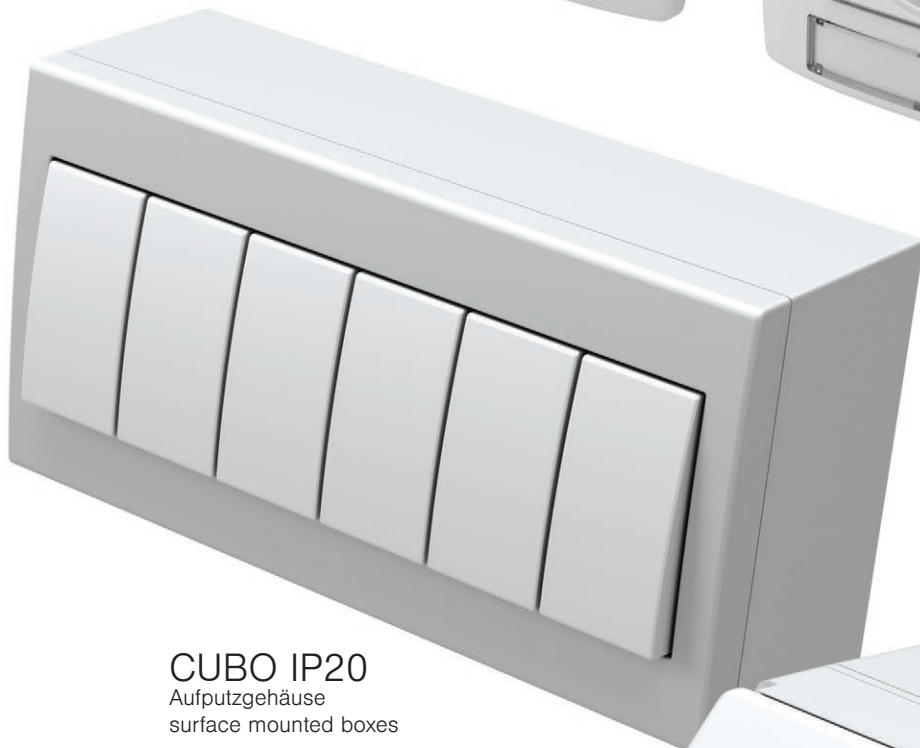

CUBO IP55  
Aufputzgehäuse  
surface mounted boxes



Brauchen Sie einen Schalter oder eine Steckdose in Unterputz-, Aufputz- oder Bodenausführung? Modul bietet verschiedene Einbaulösungen, in verschiedenen IP Schutzarten, in Brüstungskanälen, Verteilerkästen oder Bodendosen. Die Auswahl steht bei Ihnen.

Do you need switch or socket in flush, surface or floor solution? The Modul provides different mounting solutions with different IP protections, for trunking systems, distribution boards or floor boxes. The choice is yours.



**MA**

Brüstungskanäle  
trunking systems

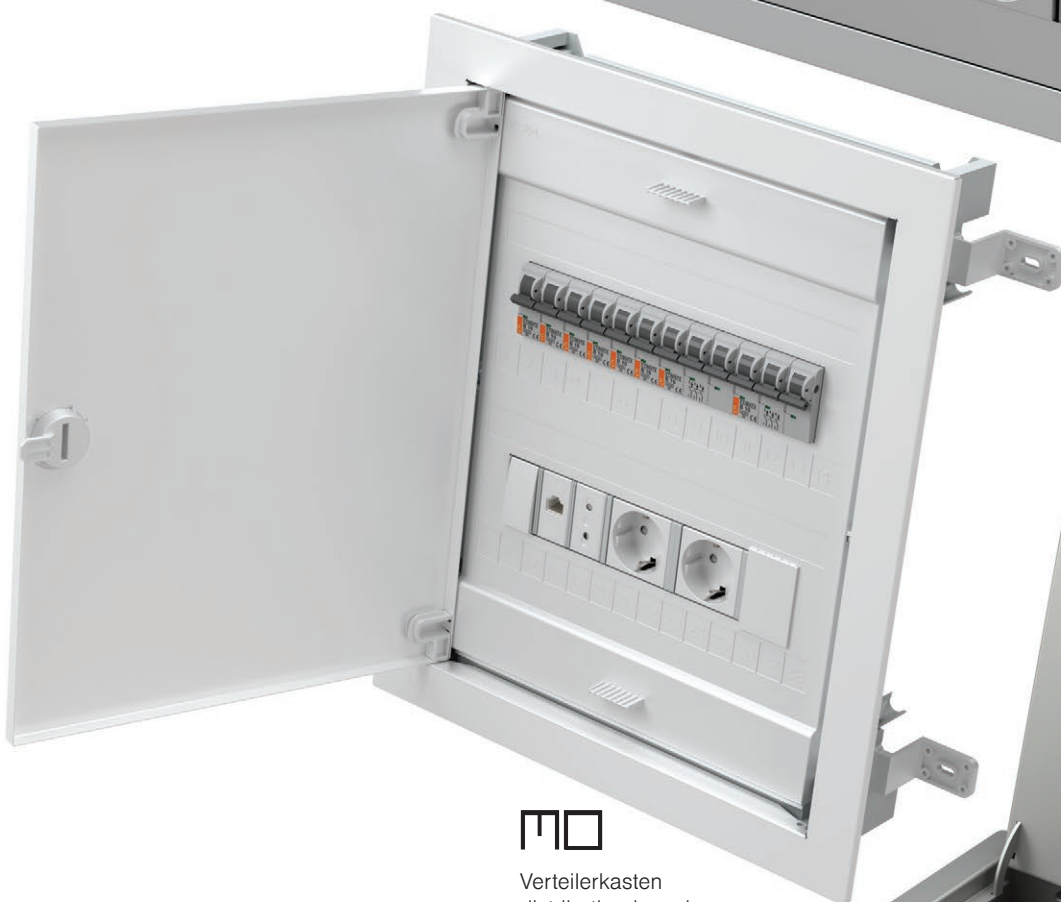

**MO**

Verteilerkasten  
distribution boards

**MT**

Bodendosen  
floor boxes



# Produktkatalog

technical catalogue







MODUL

— Funktionselemente  
*function elements*



66

Design  
*design*

PURE  
line  
soft



116

Dosen  
*boxes*



136

Vertrieb  
*distribution*



158

ekonomik —



182

fontana —



210

TEM



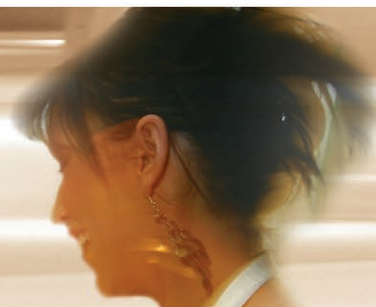

## FUNKTIONSELEMENTE FUNCTION ELEMENTS

SCHALTER SM  
SWITCHES SM



68

WIPPEN TM  
BUTTONS TM



73

BELEUCHTUNG IA  
ILLUMINATION IA



76

STECKDOSEN VM  
SOCKETS VM



78

KOMMUNIKATION KM  
COMMUNICATIONS KM



82

KOMMUNIKATIONSZUBEHÖR KA  
COMMUNICATION ACCESSORIES KA



88

ELEKTRONIK EM  
ELECTRONICS EM



91

SETS CM  
SETS CM



110

ANTIBAKTERIENPROGRAMM AW  
ANTIBACTERIAL PROGRAM AW



115

## FORM DESIGN

RAHMEN PURE OP  
COVER PLATES PURE OP



120

RAHMEN LINE OL  
COVER PLATES LINE OL



124

RAHMEN SOFT OS  
COVER PLATES SOFT OS



128

MONTAGETRÄGER NM  
MOUNTING FRAMES NM



134

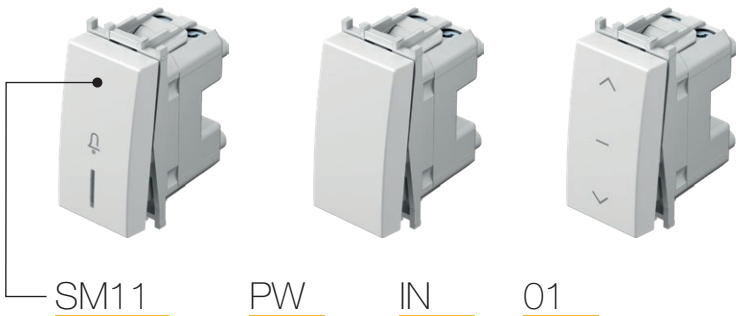

Typ type	Bezeichnung description	Technische Daten technical data	Größe size	Farbe colour	Optionsbezeichnung 1 optional data 1	Optionsbezeichnung 2 optional data 2
SM10	SCHALTER 1-POLIG SWITCH 1WAY	16AX 250V~	1M	<input type="checkbox"/> PW weiß-glänzend polar white	<input type="checkbox"/> NT neutral neutral	01
SM11	TASTER 1-POLIG PUSH BUTTON 1WAY	16A 250V~	1M	<input type="checkbox"/> SB schwarz-matt soft touch black	<input type="checkbox"/> IN Indikator indicator	02
SM12	SCHALTER 1-POLIG SWITCH 1WAY	20A 250V~	1M	<input type="checkbox"/> AT anthrazit anthracite		03
⋮	⋮	⋮	⋮	<input type="checkbox"/> ES silber-matt elox silver		
⋮	⋮	⋮	⋮	<input type="checkbox"/> IW beige-glänzend ivory white		

SCHALTER 1-POLIG 16AX 250V~ 1M



SM10

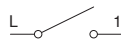

- Schalter ohne Wippe
  - 16AX 250V~, Typ SM10
  - entspricht EN 60669-1
  - Schraubklemmen 1,5--2,5 mm<sup>2</sup>
- SWITCH 1WAY 16AX 250V~ 1M**
- switch without button
  - 16AX 250V~, type SM10
  - in accordance with EN 60669-1
  - screw contacts 1.5-2.5mm<sup>2</sup>

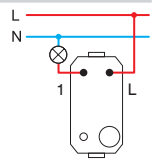

TASTER 1-POLIG 16A 250V~ 1M



SM11



- Taster ohne Wippe
  - 16A 250V~, Typ SM11
  - entspricht EN 60669-1
  - Schraubklemmen 1,5--2,5 mm<sup>2</sup>
- PUSH BUTTON 1WAY 16A 250V~ 1M**
- push button without button
  - 16A 250V~, type SM11
  - in accordance with EN 60669-1
  - screw contacts 1.5-2.5mm<sup>2</sup>

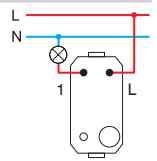

SCHALTER 1-POLIG 20A 250V~ 1M



SM12

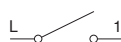

- Schalter ohne Wippe
  - 20A 250V~, Typ SM12
  - entspricht EN 60669-1
  - Schraubklemmen 1,5--2,5 mm<sup>2</sup>
- SWITCH 1WAY 20A 250V~ 1M**
- switch without button
  - 20A 250V~, type SM12
  - in accordance with EN 60669-1
  - screw contacts 1.5-2.5mm<sup>2</sup>

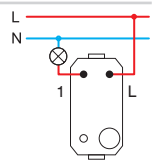

SCHALTER 2-POLIG 16AX 250V~ 1M



SM20

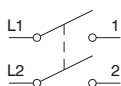

- Schalter ohne Wippe
  - 16AX 250V~, Typ SM20
  - entspricht EN 60669-1
  - Schraubklemmen 1,5--2,5 mm<sup>2</sup>
  - Nur in Kombination mit Wippe TM15
- SWITCH 2POLE 16AX 250V~ 1M**
- switch without button
  - 16AX 250V~, type SM20
  - in accordance with EN 60669-1
  - screw contacts 1.5-2.5mm<sup>2</sup>
  - only in combination with button TM15

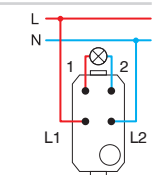



SM40

SCHALTER JALOUSIE 1-0-2 16AX 250V~ 1M

- Schalter ohne Wippe
- 16AX 250V~, Typ SM40
- entspricht EN 60669-1
- Schraubklemmen 1,5--2,5 mm<sup>2</sup>

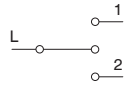

SWITCH SHUTTERS 1-0-2 16AX 250V~ 1M

- switch without button
- 16AX 250V~, type SM40
- in accordance with EN 60669-1
- screw contacts 1.5-2.5mm<sup>2</sup>

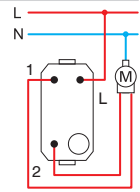

SM41

TASTER JALOUSIE 1-0-2 16A 250V~ 1M

- Taster ohne Wippe
- 16A 250V~, Typ SM41
- entspricht EN 60669-1
- Schraubklemmen 1,5--2,5 mm<sup>2</sup>

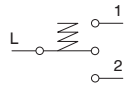

PUSH BUTTON SHUTTERS 1-0-2 16A 250V~ 1M

- push button without button
- 16A 250V~, type SM41
- in accordance with EN 60669-1
- screw contacts 1.5-2.5mm<sup>2</sup>

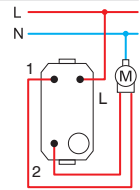

SM60

SCHALTER WECHSEL 16AX 250V~ 1M

- Schalter ohne Wippe
- 16AX 250V~, Typ SM60
- entspricht EN 60669-1
- Schraubklemmen 1,5--2,5 mm<sup>2</sup>

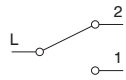

SWITCH 2WAY 16AX 250V~ 1M

- switch without button
- 16AX 250V~, type SM60
- in accordance with EN 60669-1
- screw contacts 1.5-2.5mm<sup>2</sup>

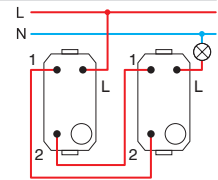

SM61

TASTER WECHSEL 16A 250V~ 1M

- Taster ohne Wippe
- 16A 250V~, Typ SM61
- entspricht EN 60669-1
- Schraubklemmen 1,5--2,5 mm<sup>2</sup>

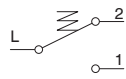

PUSH BUTTON 2WAY 16A 250V~ 1M

- push button without button
- 16A 250V~, type SM61
- in accordance with EN 60669-1
- screw contacts 1.5-2.5mm<sup>2</sup>

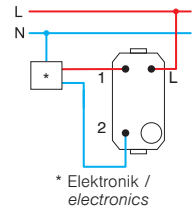

SM70

SCHALTER KREUZ 16AX 250V~ 1M

- Schalter ohne Wippe
- 16AX 250V~, Typ SM70
- entspricht EN 60669-1
- Schraubklemmen 1,5--2,5 mm<sup>2</sup>

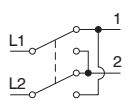

SWITCH INTERMEDIATE 16AX 250V~ 1M

- switch without button
- 16AX 250V~, type SM70
- in accordance with EN 60669-1
- screw contacts 1.5-2.5mm<sup>2</sup>

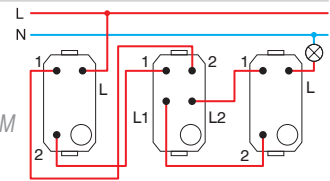

1M = 22,5 x 45  
2M = 45 x 45

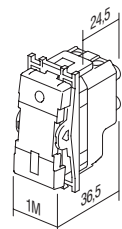
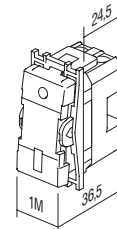



□ PW weiß-glänzend  
polar white



■ SB schwarz-matt  
soft touch black



■ AT anthrazit  
anthracite



□ ES silber-matt  
elox silver



□ IW beige-glänzend  
ivory white

SCHALTER 1-POLIG 16AX 250V~ 1M

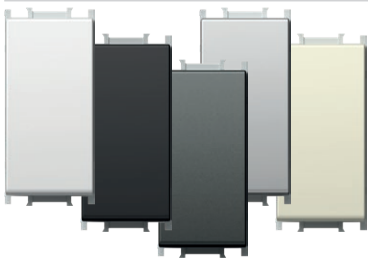

- SM10PW
- SM10SB
- SM10AT
- SM10ES
- SM10IW

- 16AX 250V~, Typ SM10  
- entspricht EN 60669-1  
- Schraubklemmen 1,5-2,5 mm<sup>2</sup>  
- Wippe auswechselbar

*SWITCH 1WAY 16AX 250V~ 1M*  
- 16AX 250V~, type SM10  
- in accordance with EN 60669-1  
- screw contacts 1.5-2.5 mm<sup>2</sup>  
- replaceable button



SCHALTER 1-POLIG 16AX 250V~ 1M \_\_ IN



- SM10PWIN
- SM10SBIN
- SM10ATIN
- SM10ESIN
- SM10IWIN

- IN Indikator  
- 16AX 250V~, Typ SM10  
- entspricht EN 60669-1  
- Schraubklemmen 1,5-2,5 mm<sup>2</sup>  
- ohne Glühlampe  
- Wippe auswechselbar

*SWITCH 1WAY 16AX 250V~ 1M \_\_ IN*  
- IN indicator  
- 16AX 250V~, type SM10  
- in accordance with EN 60669-1  
- screw contacts 1.5-2.5 mm<sup>2</sup>  
- lamp is not included  
- replaceable button



TASTER 1-POLIG 16A 250V~ 1M



- SM11PW
- SM11SB
- SM11AT
- SM11ES
- SM11IW

- 16A 250V~, Typ SM11  
- entspricht EN 60669-1  
- Schraubklemmen 1,5-2,5 mm<sup>2</sup>  
- Wippe auswechselbar

*PUSH BUTTON 1WAY 16A 250V~ 1M*  
- 16A 250V~, type SM11  
- in accordance with EN 60669-1  
- screw contacts 1.5-2.5 mm<sup>2</sup>  
- replaceable button



TASTER 1-POLIG 16A 250V~ 1M \_\_ IN 01



- SM11PWIN01
- SM11SBIN01
- SM11ATIN01
- SM11ESIN01
- SM11IWIN01

- IN 01 Indikator Klingel  
- 16A 250V~, Typ SM11  
- entspricht EN 60669-1  
- Schraubklemmen 1,5-2,5 mm<sup>2</sup>  
- ohne Glühlampe  
- Wippe auswechselbar

*PUSH BUTTON 1WAY 16A 250V~ 1M \_\_ IN 01*  
- IN 01 indicator bell  
- 16A 250V~, type SM11  
- in accordance with EN 60669-1  
- screw contacts 1.5-2.5 mm<sup>2</sup>  
- lamp is not included  
- replaceable button



## TASTER 1-POLIG 16A 250V~ 1M \_\_ IN 02



- SM11PWIN02 - IN 02 Indikator Licht
- SM11SBIN02 - 16A 250V~, Typ SM11
- SM11ATIN02 - entspricht EN 60669-1
- SM11ESIN02 - Schraubklemmen 1,5-2,5 mm<sup>2</sup>
- SM11WIN02 - ohne Glühlampe
- SM11WIN02 - Wippe auswechselbar

*PUSH BUTTON 1WAY 16A 250V~ 1M \_\_ IN 02*

- IN 02 indicator light
- 16A 250V~, type SM11
- in accordance with EN 60669-1
- screw contacts 1.5-2.5 mm<sup>2</sup>
- lamp is not included
- replaceable button



## SCHALTER 2-POLIG 16AX 250V~ 1M \_\_ NT 03



- SM20PWNT03 - NT 03 neutral 0-1
- SM20SBNT03 - 16AX 250V~, Typ SM20
- SM20ATNT03 - entspricht EN 60669-1
- SM20ESNT03 - Schraubklemmen 1,5-2,5 mm<sup>2</sup>
- SM20IWNTO3 - Wippe auswechselbar

*SWITCH 2POLE 16AX 250V~ 1M \_\_ NT 03*

- NT 03 neutral 0-1
- 16AX 250V~, type SM20
- in accordance with EN 60669-1
- screw contacts 1.5-2.5 mm<sup>2</sup>
- replaceable button



## SCHALTER 2-POLIG 16AX 250V~ 1M \_\_ IN



- SM20PWIN - IN Indikator
- SM20SBIN - 16AX 250V~, Typ SM20
- SM20ATIN - entspricht EN 60669-1
- SM20ESIN - Schraubklemmen 1,5-2,5 mm<sup>2</sup>
- SM20IWIN - ohne Glühlampe
- SM20IWIN - Wippe auswechselbar

*SWITCH 2POLE 16AX 250V~ 1M \_\_ IN*

- IN indicator
- 16AX 250V~, type SM20
- in accordance with EN 60669-1
- screw contacts 1.5-2.5 mm<sup>2</sup>
- lamp is not included
- replaceable button



## SCHALTER JALOUSIE 1-0-2 16AX 250V~ 1M \_\_ NT 10

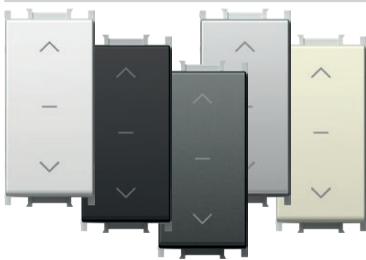

- SM40PWNT10 - NT 10 neutral 1-0-2
- SM40SBNT10 - 16AX 250V~, Typ SM40
- SM40ATNT10 - entspricht EN 60669-1
- SM40ESNT10 - Schraubklemmen 1,5-2,5 mm<sup>2</sup>
- SM40IWNTO3 - Wippe auswechselbar

*SWITCH SHUTTERS 1-0-2 16AX 250V~ 1M \_\_ NT 10*

- NT 10 neutral 1-0-2
- 16AX 250V~, type SM40
- in accordance with EN 60669-1
- screw contacts 1.5-2.5mm<sup>2</sup>
- replaceable button



## TASTER JALOUSIE 1-0-2 16A 250V~ 1M \_\_ NT 10

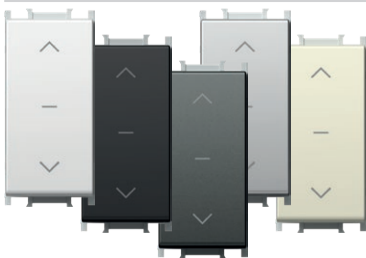

- SM41PWNT10 - NT 10 neutral 1-0-2
- SM41SBNT10 - 16A 250V~, Typ SM41
- SM41ATNT10 - entspricht EN 60669-1
- SM41ESNT10 - Schraubklemmen 1,5-2,5 mm<sup>2</sup>
- SM41IWNTO3 - Wippe auswechselbar

*PUSH BUTTON SHUTTERS 1-0-2 16A 250V~ 1M \_\_ NT 10*

- NT 10 neutral 1-0-2
- 16A 250V~, type SM41
- in accordance with EN 60669-1
- screw contacts 1.5-2.5mm<sup>2</sup>
- replaceable button



## SCHALTER WECHSEL 16AX 250V~ 1M



- SM60PW - 16AX 250V~, Typ SM60
- SM60SB - entspricht EN 60669-1
- SM60AT - Schraubklemmen 1,5-2,5 mm<sup>2</sup>
- SM60ES - Wippe auswechselbar

*SWITCH 2WAY 16AX 250V~ 1M*

- 16AX 250V~, type SM60
- in accordance with EN 60669-1
- screw contacts 1.5-2.5 mm<sup>2</sup>
- replaceable button





- SM61PW
- SM61SB
- SM61AT
- SM61ES
- SM61IW

TASTER WECHSEL 16A 250V~ 1M

- 16A 250V~, Typ SM61
- entspricht EN 60669-1
- Schraubklemmen 1,5–2,5 mm<sup>2</sup>
- Wippe auswechselbar

*PUSH BUTTON 2WAY 16A 250V~ 1M*

- 16A 250V~, type SM61
- in accordance with EN 60669-1
- screw contacts 1.5-2.5 mm<sup>2</sup>
- replaceable button



- SM62PWCD
- SM62SBCD
- SM62ATCD
- SM62ESCD
- SM62IWCD

TASTER WECHSEL MIT SCHNUR 16A 250V~ 1M \_\_ CD

- CD Indikator + Schnur
- Schnur mit einer Länge von 1,5 m
- 16A 250V~, Typ SM62
- entspricht EN 60669-1
- Schraubklemmen 1,5–2,5 mm<sup>2</sup>

*PUSH BUTTON 2WAY WITH CORD 16A 250V~ 1M \_\_ CD*

- CD indicator+cord
- cord length 1.5m
- 16A 250V~, type SM62
- in accordance with EN 60669-1
- screw contacts 1.5-2.5 mm<sup>2</sup>



- SM70PW
- SM70SB
- SM70AT
- SM70ES
- SM70IW

SCHALTER KREUZ 16AX 250V~ 1M

- 16AX 250V~, Typ SM70
- entspricht EN 60669-1
- Schraubklemmen 1,5–2,5 mm<sup>2</sup>
- Wippe auswechselbar

*SWITCH INTERMEDIATE 16AX 250V~ 1M*

- 16AX 250V~, type SM70
- in accordance with EN 60669-1
- screw contacts 1.5-2.5 mm<sup>2</sup>
- replaceable button



1M = 22,5 x 45  
2M = 45 x 45

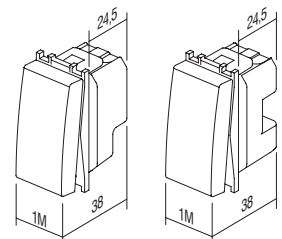



## B U T T O N S T M



TM11 PW NT 03

Typ type	Bezeichnung description	Größe size	Farbe colour	Optionsbezeichnung 1 optional data 1	Optionsbezeichnung 2 optional data 2
TM11	WIPPE BUTTON	1M	□ PW weiß-glänzend polar white	NT neutral neutral	🔔 01
TM12	WIPPE BUTTON	2M	■ SB schwarz-matt soft touch black	IN Indikator indicator	🔔 02
TM21	BLLENDE BLANK	1M	■ AT anthrazit anthracite		0 03
⋮	⋮	⋮	□ ES silber-matt elox silver		
⋮	⋮	⋮	■ IW beige-glänzend ivory white		

## WIPPE 1M

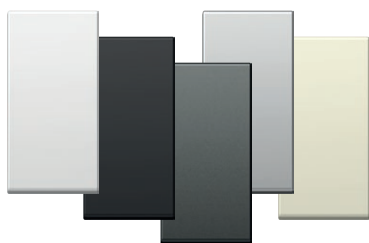

- TM11PW
- TM11SB
- TM11AT
- TM11ES
- TM11IW

- Wippe auswechselbar, Breite 1M  
- entspricht EN 60669-1

## BUTTON 1M

- replaceable button 1M  
- in accordance with EN 60669-1



## WIPPE MIT INDIKATOR 1M



- TM11PWIN
- TM11ATIN
- TM11SBIN
- TM11ESIN
- TM11IWIN

- Wippe auswechselbar, Breite 1M  
- entspricht EN 60669-1

## BUTTON 1M INDICATOR

- replaceable button 1M  
- in accordance with EN 60669-1



## WIPPE 2M

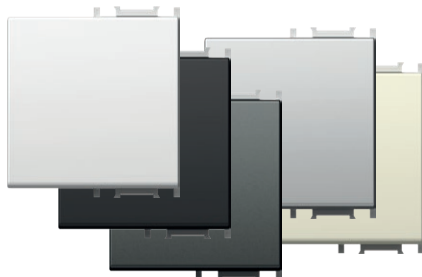

- TM12PW
- TM12SB
- TM12AT
- TM12ES
- TM12IW

- Wippe auswechselbar, Breite 2M mit Wippenträger  
- zur Erweiterung von Schaltern oder Tastern in Breite 1M auf Breite 2M  
- entspricht EN 60669-1

## BUTTON 2M

- replaceable button 2M with button carrier  
- to upgrade switch or push button from size 1M to size 2M  
- in accordance with EN 60669-1



## WIPPE MIT INDIKATOR 2M

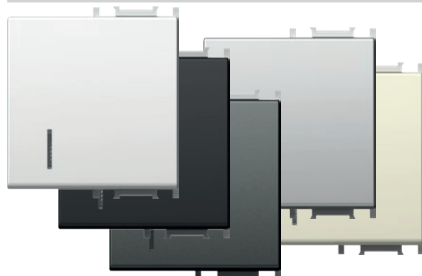

- TM12PWIN
- TM12SBIN
- TM12ATIN
- TM12ESIN
- TM12IWIN

- Wippe auswechselbar, Breite 2M mit Wippenträger  
- zur Erweiterung von Schaltern oder Tastern in Breite 1M auf Breite 2M  
- entspricht EN 60669-1

## BUTTON 2M INDICATOR

- replaceable button 2M with button carrier  
- to upgrade switch or push button from size 1M to size 2M  
- in accordance with EN 60669-1



WIPPE 2M MIT NAMENSSCHIELD

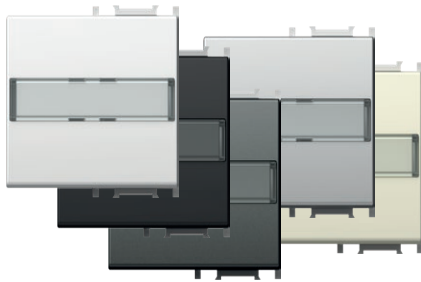

- TM13PWIL
- TM13SBIL
- TM13ATIL
- TM13ESIL
- TM13IWIL

- Wippe auswechselbar, Breite 2M mit Wippenträger  
 - zur Erweiterung von Schaltern oder Tastern in Breite  
 1M auf Breite 2M  
 - entspricht EN 60669-1

**BUTTON 2M WITH INSCRIPTION PLATE**  
 - replaceable button 2M with button carrier  
 - to upgrade switch or push button  
 from size 1M to size 2M  
 - in accordance with EN 60669-1



WIPPE 1M 2-POLIG

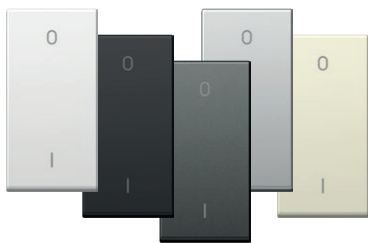

- TM15PW
- TM15SB
- TM15AT
- TM15ES
- TM15IW

- Wippe auswechselbar, Breite 1M  
 - nur in Kombination mit SM20  
 - entspricht EN 60669-1

**BUTTON 1M 2POLE**  
 - replaceable button 1M  
 - only in combination with mechanism SM20  
 - in accordance with EN 60669-1



BLENDE 1M

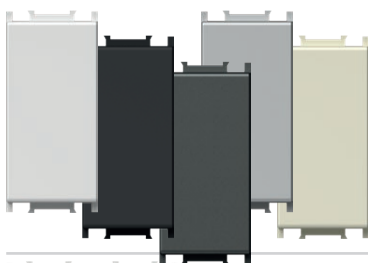

- TM21PW
- TM21SB
- TM21AT
- TM21ES
- TM21IW

- zur Ausfüllung von leeren Stellen  
 - entspricht EN 60669-1

**BLANK 1M**  
 - blank modul to fill up empty spaces  
 - in accordance with EN 60669-1



BLENDE 2M



- TM22PW
- TM22SB
- TM22AT
- TM22ES
- TM22IW

- zur Ausfüllung von leeren Stellen  
 - entspricht EN 60669-1

**BLANK 2M**  
 - blank modul to fill up empty spaces  
 - in accordance with EN 60669-1



KABELEINFÜHRUNG 1M

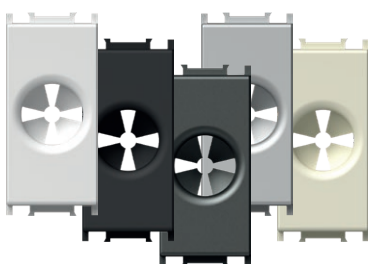

- TM31PW
- TM31SB
- TM31AT
- TM31ES
- TM31IW

- Einführung für Kabel  
 - entspricht EN-60669-1

**CABLE OUTLET 1M**  
 - outlet for cable  
 - in accordance with EN-60669-1



1M = 22,5 x 45  
 2M = 45 x 45

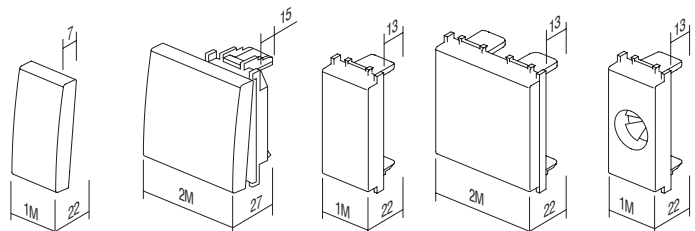

TM11  
TM15

TM12  
TM13

TM21

TM22

TM31

BUTTONS T M

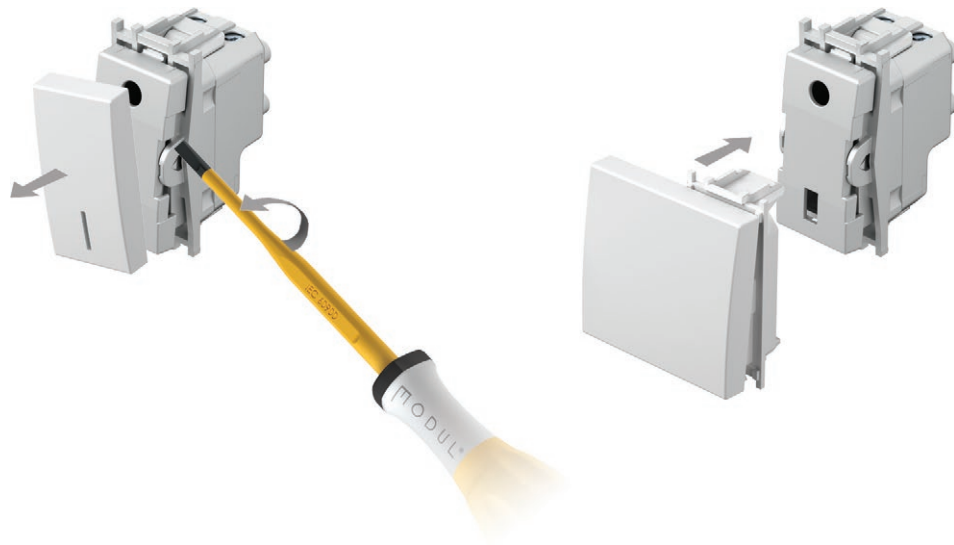

LASERDRUCK AUF WIPPEN

- Laserdruck von beliebigen Symbolen auf gekennzeichnete Stellen
- Standardsymbole auf Lager, andere nach Bestellung

LASER PRINT ON BUTTONS

- laser print of any graphics on marked locations
- standard symbols from stock, other on request

1M

A
B
C

2M

A	D	G
B	E	H
C	F	I

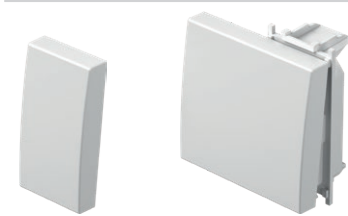

GRAPHIKEN

SYMBOLS

01	02	03	04	05	06	07	08	09	10	11	12	20	21	22	23
24	25	26	27	28	29	30	31	32	33	34	35	36	37	38	39
40	41	42	43	44	45	46	47	48							

STANDARDGRAPHIKEN

STANDARD SYMBOLS

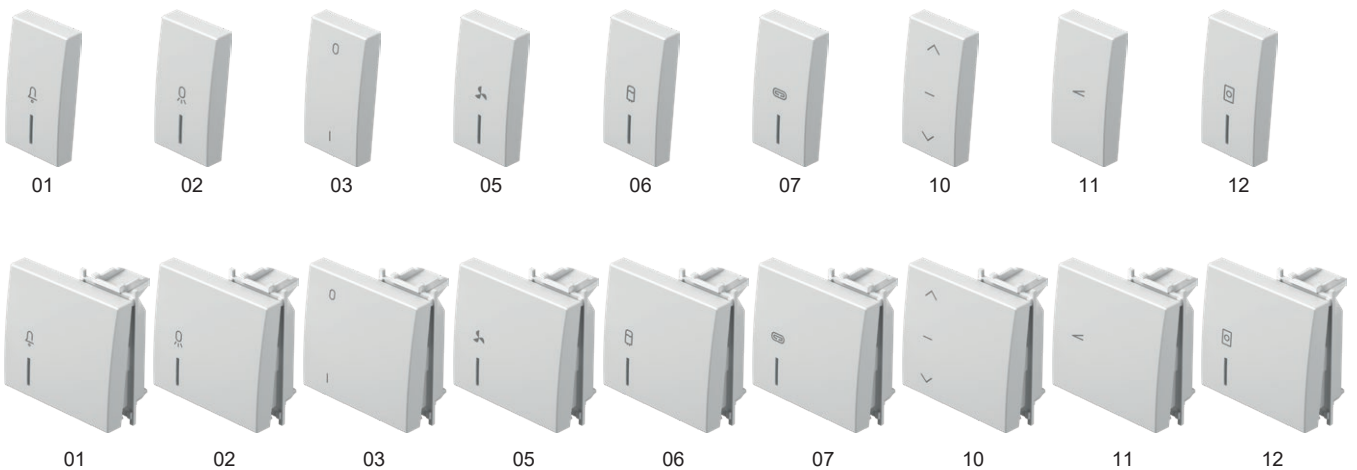

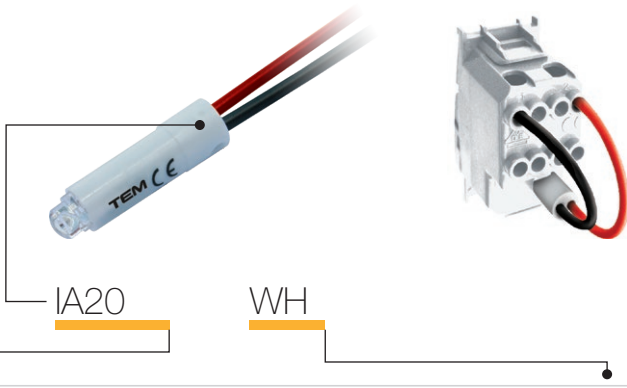

Typ type	Bezeichnung description	Technische Daten technical data	Farbe colour
IA10	GLÜHLAMPE NEON LAMP	230V~ 0,34W	<input type="checkbox"/> WH weiß white
IA20	LED-LAMPE LED LAMP	230V~ AC/DC 0,40W	<input checked="" type="checkbox"/> BL blau blue
IA21	LED-LAMPE LED LAMP	24V AC/DC 0,20W	<input checked="" type="checkbox"/> RD rot red
⋮	⋮	⋮	<input checked="" type="checkbox"/> GR grün green
⋮	⋮	⋮	<input checked="" type="checkbox"/> OR orange orange

**GLÜHLAMPE 230V~ 0,34 W**

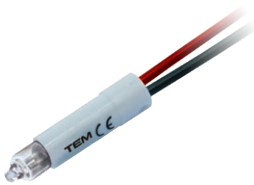

IA10OR

- zur Kontrollbeleuchtung, Beleuchtung oder ständige Beleuchtung des Schalters
- in Kombination mit Wippe mit einem Indikator

**NEON LAMP 230V~ 0,34W**

- for indication, illumination or constant illumination of switch
- in combination with button with indicator

**LED-LAMPE 230V AC/DC 0,40 W**



- IA20WH
- IA20GR
- IA20RD
- IA20BL

- zur Kontrollbeleuchtung, Beleuchtung oder ständige Beleuchtung des Schalters
- in Kombination mit Wippe mit einem Indikator

**LED LAMP 230V AC/DC 0,40W**

- for indication, illumination or constant illumination of switch
- in combination with button with indicator

**LED-LAMPE 24V AC/DC 0,20W**



- IA21WH
- IA21RD

- zur Kontrollbeleuchtung, Beleuchtung oder ständige Beleuchtung des Schalters
- in Kombination mit Wippe mit einem Indikator

**LED LAMP 24V AC/DC 0,20W**

- for indication, illumination or constant illumination of switch
- in combination with button with indicator

**LED-LAMPE 12V AC/DC 0,10W**



- IA22WH
- IA22RD

- zur Kontrollbeleuchtung, Beleuchtung oder ständige Beleuchtung des Schalters
- in Kombination mit Wippe mit einem Indikator

**LED LAMP 12V AC/DC 0,10W**

- for indication, illumination or constant illumination of switch
- in combination with button with indicator

**RC-SCHALTUNG 250V~**



IA50

- RC-Schaltung für Störungsbehebung beim Betrieb von LED-Lampen -mehrere RC
- Schaltungen können mit den Lampen verbunden werden
- 0,1 µF, 100 Ω, 250V~

**RC CIRCUIT 250V~**

- RC circuit to eliminate disturbances in the operation of LED lamps
- parallel connections of more RC circuits with lamps are possible
- 0,1 µF, 100 Ω, 250V~

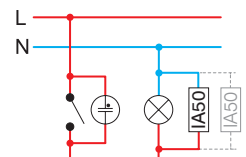

\* Kontrollbeleuchtung /  
Indication

Beleuchtung /  
Illumination

Ständige Beleuchtung /  
Constant illumination

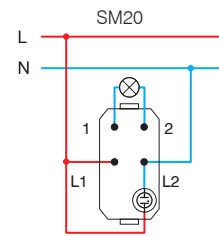
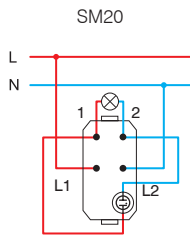
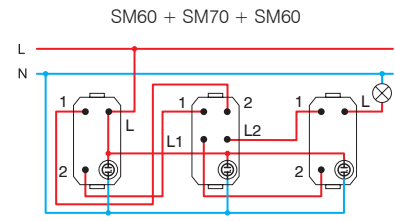
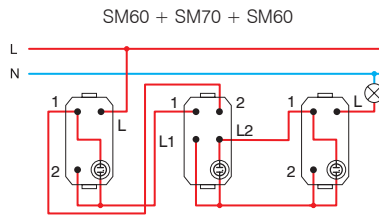
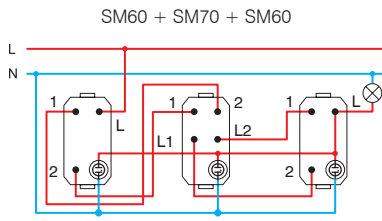
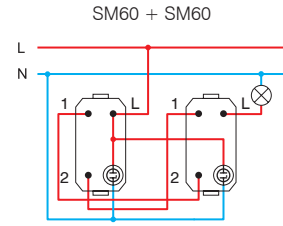
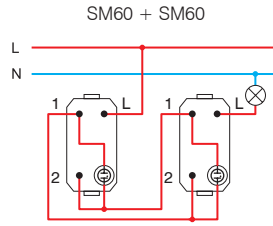
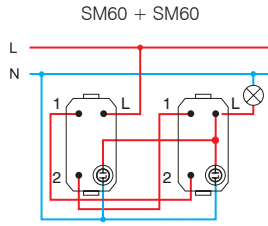
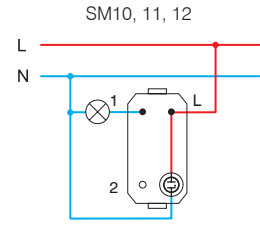
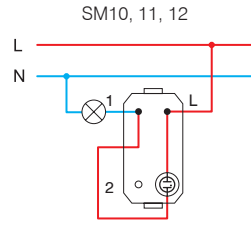
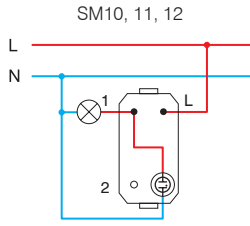

\* Schaltung geeignet für Sparlampen (CFL, LED) /  
wiring scheme for energy saving lamps (CFL, LED)

1M = 22,5 x 45  
2M = 45 x 45

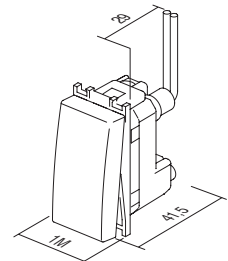

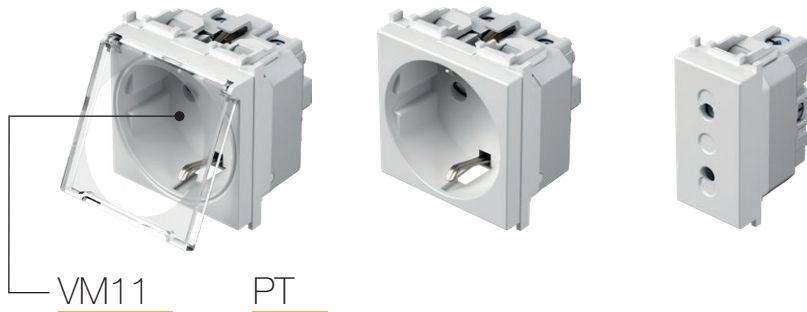

Typ type	Bezeichnung description	Technische Daten technical data	Größe size	Farbe colour																		
VM10	STECKDOSE SCHUKO+KS SOCKET SCHUKO+KS	2P+E 16A 250V~	2M	<table border="0"> <tr> <td> PW weiß-glänzend polar white</td> <td> PT weiß + transparent white+transparent</td> <td> PP weiß + weiß white+white</td> </tr> </table>	PW weiß-glänzend polar white	PT weiß + transparent white+transparent	PP weiß + weiß white+white															
PW weiß-glänzend polar white	PT weiß + transparent white+transparent	PP weiß + weiß white+white																				
VM11	STECKDOSE SCHUKO+KS+KLAPPDECKEL SOCKET SCHUKO+KS+COVER	2P+E 16A 250V~	2M	<table border="0"> <tr> <td> SB schwarz-matt soft touch black</td> <td> BT schwarz + transparent black+transparent</td> <td> BB schwarz + schwarz soft touch black+black</td> </tr> </table>	SB schwarz-matt soft touch black	BT schwarz + transparent black+transparent	BB schwarz + schwarz soft touch black+black															
SB schwarz-matt soft touch black	BT schwarz + transparent black+transparent	BB schwarz + schwarz soft touch black+black																				
VM20	STECKDOSE EURO+KS SOCKET EURO+KS	2P 10A 250V~	1M	<table border="0"> <tr> <td> AT anthrazit anthracite</td> <td> AT anthrazit+transparent anthracite+transparent</td> <td> AA anthrazit+anthrazit anthracite+anthracite</td> </tr> <tr> <td> ES silber-matt elox silver</td> <td> ST silber + transparent silver+transparent</td> <td> SS silber + silber silver+silver</td> </tr> <tr> <td> IW beige-glänzend ivory white</td> <td> IT beige + transparent ivory+transparent</td> <td> II beige + beige ivory+ivory</td> </tr> <tr> <td> RD rot red</td> <td> RT rot + transparent red+transparent</td> <td> RR rot + rot red+red</td> </tr> <tr> <td> GR grün green</td> <td> GT grün + transparent green+transparent</td> <td> GG grün + grün green+green</td> </tr> <tr> <td> OR orange orange</td> <td> OT orange + transparent orange+transparent</td> <td> OO orange + orange orange+orange</td> </tr> </table>	AT anthrazit anthracite	AT anthrazit+transparent anthracite+transparent	AA anthrazit+anthrazit anthracite+anthracite	ES silber-matt elox silver	ST silber + transparent silver+transparent	SS silber + silber silver+silver	IW beige-glänzend ivory white	IT beige + transparent ivory+transparent	II beige + beige ivory+ivory	RD rot red	RT rot + transparent red+transparent	RR rot + rot red+red	GR grün green	GT grün + transparent green+transparent	GG grün + grün green+green	OR orange orange	OT orange + transparent orange+transparent	OO orange + orange orange+orange
AT anthrazit anthracite	AT anthrazit+transparent anthracite+transparent	AA anthrazit+anthrazit anthracite+anthracite																				
ES silber-matt elox silver	ST silber + transparent silver+transparent	SS silber + silber silver+silver																				
IW beige-glänzend ivory white	IT beige + transparent ivory+transparent	II beige + beige ivory+ivory																				
RD rot red	RT rot + transparent red+transparent	RR rot + rot red+red																				
GR grün green	GT grün + transparent green+transparent	GG grün + grün green+green																				
OR orange orange	OT orange + transparent orange+transparent	OO orange + orange orange+orange																				



STECKDOSE SCHUKO+KS 2P+E 16A 250V~ 2M

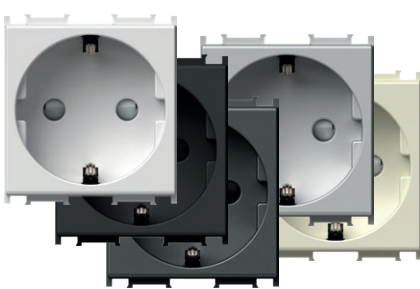

- VM10PW
- VM10SB
- VM10AT
- VM10ES
- VM10IW

- Steckdose mit Schutzkontakt
- 16A 250V~, Typ VM10
- entspricht IEC 60884-1, CEE7
- Schraubklemmen 1,5-2,5 mm<sup>2</sup>
- Steckdose mit erhöhtem Berührungsschutz



SOCKET SCHUKO+KS 2P+E 16A 250V~ 2M

- 2P+E schuko
- 16A 250V~, type VM10
- in accordance with IEC 60884-1, CEE7
- screw contacts 1.5-2.5 mm<sup>2</sup>
- shuttered live contacts

STECKDOSE SCHUKO+KS 2P+E 16A 250V~ 2M

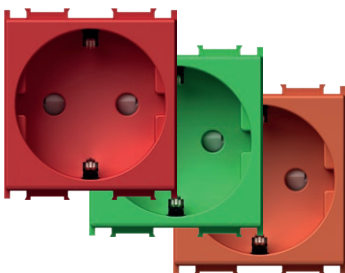

- VM10RD
- VM10GR
- VM10OR

- Steckdose mit Schutzkontakt
- 16A 250V~, Typ VM10
- entspricht IEC 60884-1, CEE7
- Schraubklemmen 1,5-2,5 mm<sup>2</sup>
- Steckdose mit erhöhtem Berührungsschutz



SOCKET SCHUKO+KS 2P+E 16A 250V~ 2M

- 2P+E schuko
- 16A 250V~, type VM10
- in accordance with IEC 60884-1, CEE7
- screw contacts 1.5-2.5 mm<sup>2</sup>
- shuttered live contacts

STECKDOSE SCHUKO+KS+KLAPPDECKEL 2P+E 16A 250V~ 2M

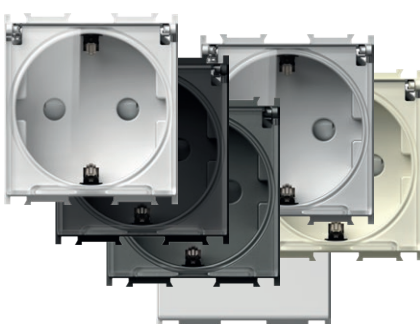

- VM11PT
- VM11BT
- VM11AT
- VM11ST
- VM11IT
- VM11PP

- Steckdose mit Schutzkontakt mit Klappdeckel
- 16A 250V~, Typ VM11
- entspricht IEC 60884-1, CEE7
- Schraubklemmen 1,5-2,5 mm<sup>2</sup>
- Steckdose mit erhöhtem Berührungsschutz



SOCKET SCHUKO+KS+COVER  
2P+E 16A 250V~ 2M

- 2P+E schuko+cover
- 16A 250V~, type VM11
- in accordance with IEC 60884-1, CEE7
- screw contacts 1.5-2.5 mm<sup>2</sup>
- shuttered live contacts

## S O C K E T S V M

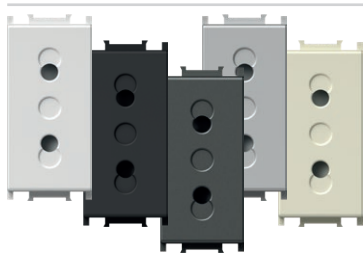

- VM20PW
- VM20SB
- VM20AT
- VM20ES
- VM20IW

## STECKDOSE EURO+KS 2P 10A 250V~ 1M

- 2P Eurosteckdose
- 10A 250V~, Typ VM20
- entspricht IEC 60884-1, CEE7
- Schraubklemmen 1,5-2,5 mm<sup>2</sup>
- Steckdose mit erhöhtem Berührungsschutz

## SOCKET EURO+KS 2P 10A 250V~ 1M

- 2P Euro
- 10A 250V~, type VM20
- in accordance with IEC 60884-1, CEE7
- screw contacts 1.5-2.5 mm<sup>2</sup>
- shuttered live contacts

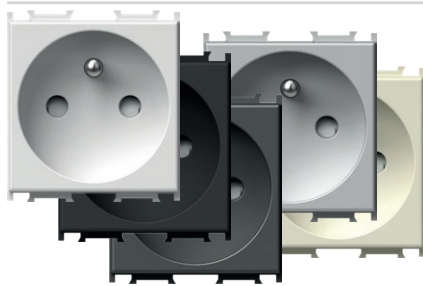

- VM40PW
- VM40SB
- VM40AT
- VM40ES
- VM40IW



## STECKDOSE FRANZÖSISCH+KS 2P+E 16A 250V~ 2M

- Steckdose mit Schutzkontakt, französischer Standard
- 16A 250V~, Typ VM40
- entspricht IEC 60884-1, NF C 61-314, CEE7
- Schraubklemmen 1,5-2,5 mm<sup>2</sup>
- Steckdose mit erhöhtem Berührungsschutz

## SOCKET FRENCH+KS 2P+E 16A 250V~ 2M

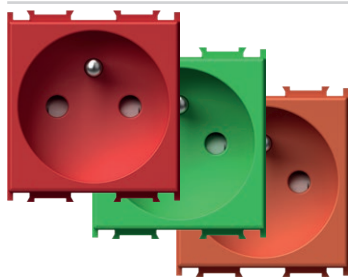
- 2P+E French
- 16A 250V~, type VM40
- in accordance with IEC 60884-1, NF C 61-314, CEE7
- screw contacts 1.5-2.5 mm<sup>2</sup>
- shuttered live contacts



-  VM40RD
-  VM40GR
-  VM40OR

## STECKDOSE FRANZÖSISCH+KS 2P+E 16A 250V~ 2M

- Steckdose mit Schutzkontakt, französischer Standard
- 16A 250V~, Typ VM40
- entspricht IEC 60884-1, NF C 61-314, CEE7
- Schraubklemmen 1,5-2,5 mm<sup>2</sup>
- Steckdose mit erhöhtem Berührungsschutz

## SOCKET FRENCH+KS 2P+E 16A 250V~ 2M

- 2P+E French
- 16A 250V~, type VM40
- in accordance with IEC 60884-1, NF C 61-314, CEE7
- screw contacts 1.5-2.5 mm<sup>2</sup>
- shuttered live contacts



- VM41PT
- VM41BT
- VM41AT
- VM41ST
- VM41IT

## STECKDOSE FRANZÖSISCH+KS+KLAPPDECKEL 2P+E 16A 250V~ 2M

- Steckdose mit Schutzkontakt mit Klappdeckel, französischer Standard
- 16A 250V~, Typ VM41
- entspricht IEC 60884-1, NF C 61-314, CEE7
- Schraubklemmen 1,5-2,5 mm<sup>2</sup>
- Steckdose mit erhöhtem Berührungsschutz

## SOCKET FRENCH+KS+COVER

- 2P+E 16A 250V~ 2M
- 2P+E French+cover
- 16A 250V~, type VM41
- in accordance with IEC 60884-1, NF C 61-314, CEE7
- screw contacts 1.5-2.5 mm<sup>2</sup>
- shuttered live contacts

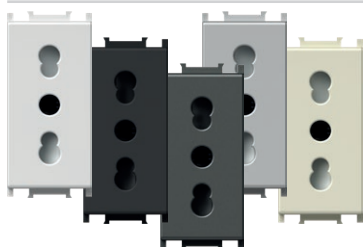

- VM30PW
- VM30SB
- VM30AT
- VM30ES
- VM30IW

## STECKDOSE ITALIENISCH P17/11+KS 2P+E 16A 250V~ 1M

- Steckdose mit Schutzkontakt, italienischer Standard P17/11
- 16A 250V~, Typ VM30
- entspricht IEC 60884-1, CEI 23-50
- Schraubklemmen 1,5-2,5 mm<sup>2</sup>
- Steckdose mit erhöhtem Berührungsschutz

## SOCKET ITALIAN P17/11+KS 2P+E 16A 250V~ 1M

- 2P+E Italian P17/11
- 16A 250V~, type VM30
- in accordance with IEC 60884-1, CEI 23-50
- screw contacts 1.5-2.5 mm<sup>2</sup>
- shuttered live contacts

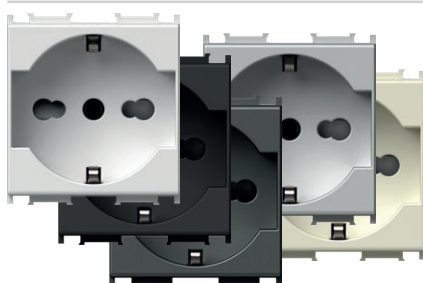

- VM31PW
- VM31SB
- VM31AT
- VM31ES
- VM31IW

## STECKDOSE SCHUKO/ITA P17/11+KS 2P+E 16A 250V~ 2M

- Steckdose mit Schutzkontakt, italienischer Standard P17/11
- 16A 250V~, Typ VM31
- entspricht IEC 60884-1, CEI 23-50
- Schraubklemmen 1,5-2,5 mm<sup>2</sup>
- Steckdose mit erhöhtem Berührungsschutz

## SOCKET SCHUKO/ITA P17/11+KS

- 2P+E 16A 250V~ 2M
- 2P+E schuko/italian P17/11
- 16A 250V~, type VM31
- in accordance with IEC 60884-1, CEI 23-50
- screw contacts 1.5-2.5 mm<sup>2</sup>
- shuttered live contacts

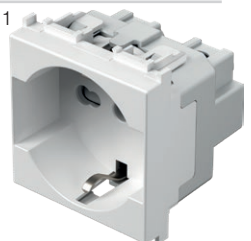

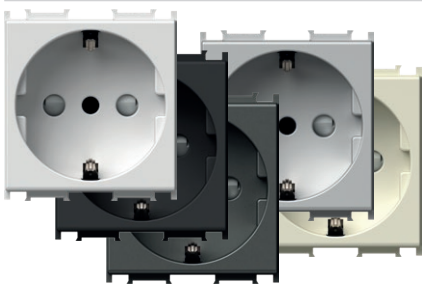

- VM32PW
- VM32SB
- VM32AT
- VM32ES
- VM32IW

**STECKDOSE SCHUKO/ITA P30+KS 2P+E 16A 250V~ 2M**

- Steckdose mit Schutzkontakt, italienischer Standard P30
- 16A 250V~, Typ VM32
- entspricht IEC 60884-1, CEI 23-50
- Schraubklemmen 1,5-2,5 mm<sup>2</sup>
- Steckdose mit erhöhtem Berührungsschutz



**SOCKET SCHUKO/ITA P30+KS 2P+E 16A 250V~ 2M**

- 2P+E schuko/Italian P30
- 16A 250V~, type VM32
- in accordance with IEC 60884-1, CEI 23-50
- screw contacts 1.5-2.5 mm<sup>2</sup>
- shuttered live contacts

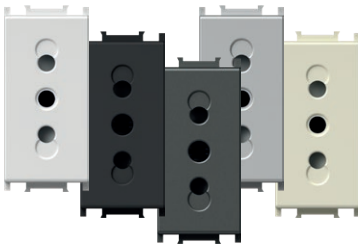

- VM33PW
- VM33SB
- VM33AT
- VM33ES
- VM33IW

**STECKDOSE ITALIENISCH P11+KS 2P+E 10A 250V~ 1M**

- Steckdose mit Schutzkontakt, italienischer Standard P11
- 10A 250V~, Typ VM33
- entspricht IEC 60884-1, CEI 23-50
- Schraubklemmen 1,5-2,5 mm<sup>2</sup>
- Steckdose mit erhöhtem Berührungsschutz



**SOCKET ITALIAN P11+KS 2P+E 10A 250V~ 1M**

- 2P+E Italian P11
- 10A 250V~, type VM33
- in accordance with IEC 60884-1, CEI 23-50
- screw contacts 1.5-2.5 mm<sup>2</sup>
- shuttered live contacts

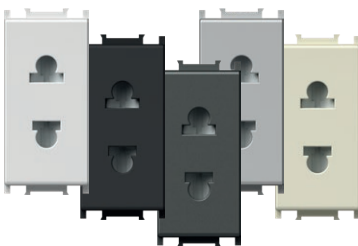

- VM21PW
- VM21SB
- VM21AT
- VM21ES
- VM21IW

**STECKDOSE EURO/AMERIKANISCH+KS 2P 16A 250V~ 1M**

- 2P Euro/amerikanischer Standard
- 16A 250V~, Typ VM21
- Schraubklemmen 1,5-2,5 mm<sup>2</sup>
- Steckdose mit erhöhtem Berührungsschutz
- nur für Länder außer EU



**SOCKET EURO/AMERICAN+KS 2P 16A 250V~ 1M**

- 2P Euro/American
- 16A 250V~, type VM21
- screw contacts 1.5-2.5 mm<sup>2</sup>
- shuttered live contacts
- only for countries not members of EU

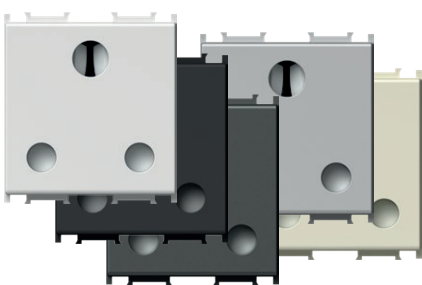

- VM51PW
- VM51SB
- VM51AT
- VM51ES
- VM51IW

**STECKDOSE BRITISCH BS 546+KS 2P+E 15A 250V~ 2M**

- Steckdose mit Schutzkontakt, britischer Standard BS 546
- 15A 250V~, Typ VM51
- entspricht BS 546
- Schraubklemmen 1,5-4 mm<sup>2</sup>
- Schutz gegen Berührung stromführender Teile

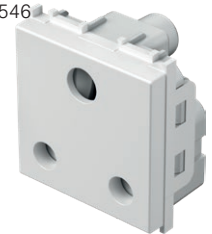

**SOCKET BRITISH BS 546+KS 2P+E 15A 250V~ 2M**

- 2P+E British BS 546
- 15A 250V~, type VM51
- in accordance with BS 546
- screw contacts 1.5-4 mm<sup>2</sup>
- shuttered live contacts

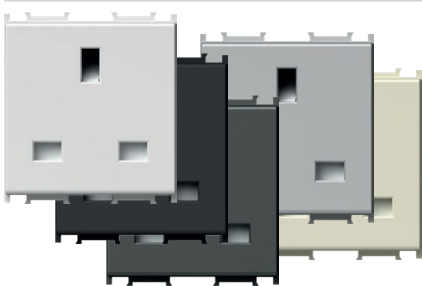

- VM52PW
- VM52SB
- VM52AT
- VM52ES
- VM52IW

**STECKDOSE BRITISCH BS 1363-2+KS 2P+E 13A 250V~ 2M**

- Steckdose mit Schutzkontakt, britischer Standard BS 1363-2
- 13A 250V~, Typ VM52
- entspricht BS 1363-2
- Schraubklemmen 1,5-4 mm<sup>2</sup>
- Schutz gegen Berührung stromführender Teile

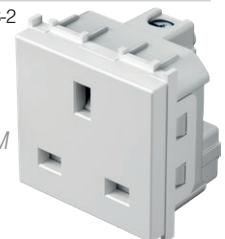

**SOCKET BRITISH BS 1363-2+KS 2P+E 13A 250V~ 2M**

- 2P+E British BS 1363-2
- 13A 250V~, type VM52
- in accordance with BS 1363-2
- screw contacts 1.5-4 mm<sup>2</sup>
- shuttered live contacts



VM80

**ÜBERSpannungSSchutz MPE MINI 275V/50Hz**

- Parallelanschluss zur ersten Steckdose in Reihe
- Schutzklasse III
- Uc=275Vac, Uoc/Isc=6kV/3kA, Up<800V
- entspricht IEC 61643-1
- Leiter 1,5 mm<sup>2</sup>, IP20
- Signalton bei Zerstörung



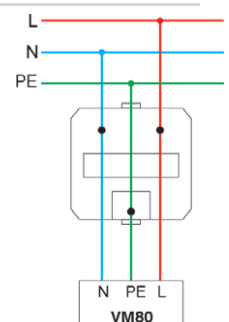

**SURGE PROTECTOR MPE MINI 275V/50Hz**

- parallel connection with the first socket in the row
- protection class III
- Uc=275Vac, Uoc/Isc=6kV/3kA, Up<800V
- in accordance with IEC 61643-1
- wires 1.5mm<sup>2</sup>, IP20
- sound signal at breakdown







STECKDOSEN- UND STECKER-ÜBEREINSTIMMUNG  
 SOCKETS AND PLUGS MATCHING

STECKDOSE / SOCKET	VM10 VM11	VM20	VM30	VM33	VM31	VM32	VM40 VM41	VM21
STECKERTYP / PLUG STYLE  deutsch / German 	•				•	•		
französisch / French 	•				•	•	•	
italienisch / Italian S11 			•	•	•	•		
italienisch / Italian S17 			•	•	•			
euro 	•	•	•		•	•	•	•

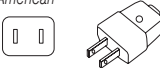
STECKDOSEN- UND STECKER-ÜBEREINSTIMMUNG  
 SOCKETS AND PLUGS MATCHING

STECKDOSE / SOCKET	VM21	VM51	VM52
STECKERTYP / PLUG STYLE  amerikanisch / American 	•		
britisch / British BS 546 		•	
britisch / British BS 1363-2 			•

1M = 22,5 x 45  
 2M = 45 x 45

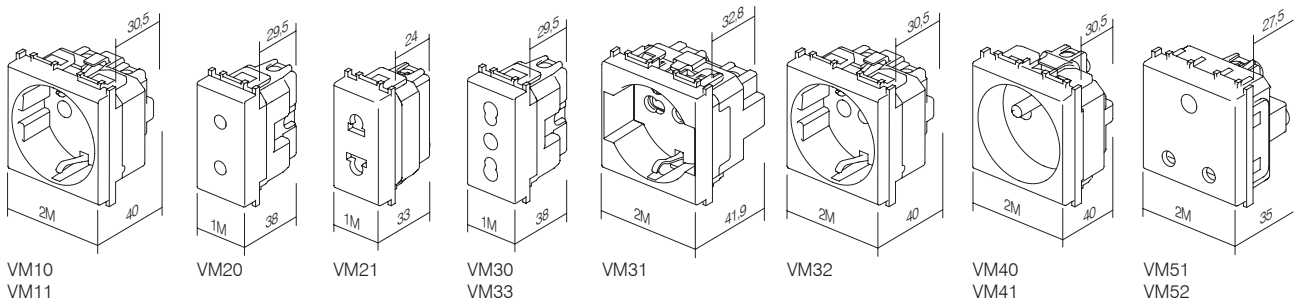



Typ type	Bezeichnung description	Technische Daten technical data	Größe size	Farbe colour
KM10	STECKDOSE TV – EINZELDOSE SOCKET TV BASIC	0dB	1M	<input type="checkbox"/> PW weiß-glänzend polar white
KM11	STECKDOSE TV – ENDDOSE SOCKET TV END-LINE	1dB	1M	<input checked="" type="checkbox"/> SB schwarz-matt soft touch black
KM12	STECKDOSE TV – DURCHGANGSDOSE SOCKET TV TROUGHPASS	10dB	1M	<input checked="" type="checkbox"/> AT anthrazit anthracite
⋮	⋮	⋮	⋮	<input type="checkbox"/> ES silber-matt elox silver
⋮	⋮	⋮	⋮	<input type="checkbox"/> IW beige-glänzend ivory white

TV-EINZELDOSE 0dB 1M



- KM10PW
- KM10SB
- KM10AT
- KM10ES
- KM10IW

- TV-Einzeldose  
- Dämpfung 0 dB  
- Rückanschluss – F-Standard  
**SOCKET TV BASIC 0dB 1M**  
- TV basic  
- reduction 0dB  
- back connector – F standard



TV-EINZELDOSE 0dB 2M

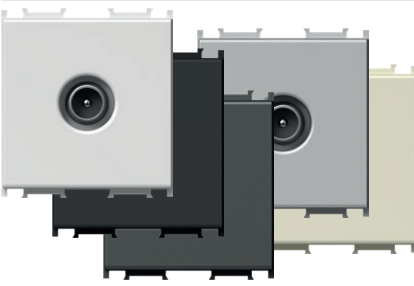

- KM20PW
- KM20SB
- KM20AT
- KM20ES
- KM20IW

- TV-Einzeldose  
- Dämpfung 0 dB  
- Rückanschluss – F-Standard  
**SOCKET TV BASIC 0dB 2M**  
- TV basic  
- reduction 0dB  
- back connector – F standard



TV-ENDDOSE 1dB 1M



- KM11PW
- KM11SB
- KM11AT
- KM11ES
- KM11IW

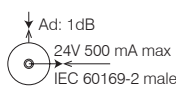

- TV-Enddose  
- Übertragungsbandbreite 5÷2400 MHz  
- Dämpfung < 1 dB  
- entspricht EN 50083-1  
- Schraubklemmen  
**SOCKET TV END-LINE 1dB 1M**  
- TV end-line  
- frequency range 5÷2400 MHz  
- reduction < 1 dB  
- in accordance with EN 50083-1  
- screw contacts



TV-DURCHGANGSDOSE 10dB 1M



- KM12PW
- KM12SB
- KM12AT
- KM12ES
- KM12IW

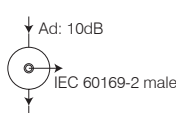

- TV-Durchgangsdose  
- Übertragungsbandbreite 5÷2400 MHz  
- Dämpfung < 10 dB  
- entspricht EN 50083-1  
- Schraubklemmen  
**SOCKET TV TROUGHPASS 10dB 1M**  
- TV troughpass  
- frequency range 5÷2400 MHz  
- reduction < 10 dB  
- in accordance with EN 50083-1  
- screw contacts



SAT-EINZELDOSE 0dB 1M



- KM15PW
- KM15SB
- KM15AT
- KM15ES
- KM15IW

- SAT-Einzeldose
- Dämpfung 0 dB
- Rückanschluss – F-Standard
- SOCKET SAT BASIC 0dB 1M*
- SAT basic
- reduction 0dB
- back connector – F standard



SAT-EINZELDOSE 0dB 2M

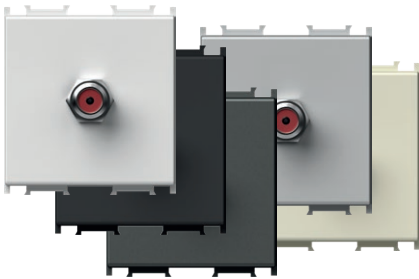

- KM24PW
- KM24SB
- KM24AT
- KM24ES
- KM24IW

- SAT-Einzeldose
- Dämpfung 0 dB
- Rückanschluss – F-Standard
- SOCKET SAT BASIC 0dB 2M*
- SAT basic
- reduction 0dB
- back connector – F standard



SAT-ENDDOSE 1dB 1M

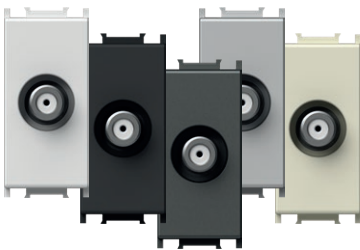

- KM16PW
- KM16SB
- KM16AT
- KM16ES
- KM16IW

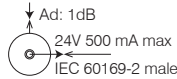

- SAT-Enddose
- Übertragungsbandbreite 5÷2400 MHz
- Dämpfung < 1dB
- entspricht EN 50083-1
- Schraubklemmen
- SOCKET SAT END-LINE 1dB 1M*
- SAT end-line
- frequency range 5÷2400 MHz
- reduction < 1dB
- in accordance with EN 50083-1
- screw contacts



R-EINZELDOSE 0dB 1M



- KM19PW
- KM19SB
- KM19AT
- KM19ES
- KM19IW

- R-Einzeldose
- Dämpfung 0 dB
- Rückanschluss – F-Standard
- SOCKET R BASIC 0dB 1M*
- R basic
- reduction 0dB
- back connector – F standard



R-EINZELDOSE 0dB 2M

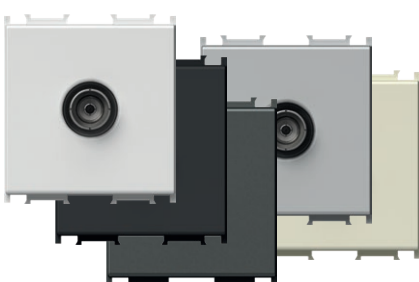

- KM29PW
- KM29SB
- KM29AT
- KM29ES
- KM29IW

- R-Einzeldose
- Dämpfung 0 dB
- Rückanschluss – F-Standard
- SOCKET R BASIC 0dB 2M*
- R basic
- reduction 0dB
- back connector – F standard



SAT-TV-ENDDOSE 1dB 2M

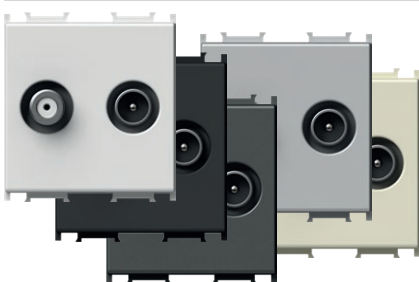

- KM25PW
- KM25SB
- KM25AT
- KM25ES
- KM25IW

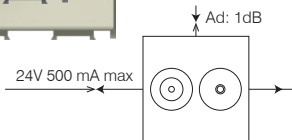

- SAT-TV-Enddose
- Übertragungsbandbreite 5÷2400 MHz
- Dämpfung < 1dB
- entspricht EN 50083-1
- Schraubklemmen
- SOCKET SAT-TV END-LINE 1dB 2M*
- SAT-TV end-line
- frequency range 5÷2400 MHz
- reduction < 1dB
- in accordance with EN 50083-1
- screw contacts



GRUNDSCHALTUNGEN  
BASIC CONNECTION SAMPLES

Einzelanschaltung  
stand alone connection

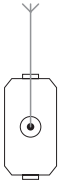

KM10  
KM20  
KM11  
KM15  
KM24  
KM16  
KM19  
KM29  
KM25

Sternschaltung  
star connection

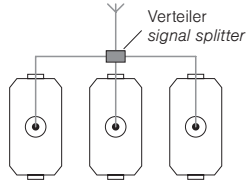

KM10  
KM20  
KM11  
KM15  
KM24  
KM16  
KM19  
KM29  
KM25

Durchgangsschaltung  
throughpass connection

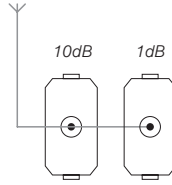

KM12 KM11



- KM22PW
- KM22SB
- KM22AT
- KM22ES
- KM22IW

STECKDOSE AUDIO 2xRCA 1M

- Audio-Anschlussdose – 2x RCA
- gelöteter Kabelanschluss hinten

SOCKET AUDIO 2xRCA 1M

- audio 2x RCA
- soldering connection of cable at the back side



- KM23PW
- KM23SB
- KM23AT
- KM23ES
- KM23IW

STECKDOSE AUDIO-LAUTSPRECHER 1M

- Audio-Anschlussdose – 2x Ø4 mm
- Kabelanschluss für Lautsprecher, Stecker Ø4 mm oder Gabel-Kabelstecker
- gelöteter Kabelanschluss hinten

SOCKET AUDIO LOUDSPEAKERS 1M

- audio 2x Ø4mm
- to accommodate speaker wire, banana plug Ø4mm or spades
- soldering connection of cable at the back side



- KM26PW
- KM26SB
- KM26AT
- KM26ES
- KM26IW

STECKDOSE AUDIO-LAUTSPRECHER 2M

- Audio-Anschlussdose – 2x Ø4 mm
- Kabelanschluss für Lautsprecher, Stecker Ø4 mm oder Gabel-Kabelstecker
- gelöteter Kabelanschluss hinten

SOCKET AUDIO LOUDSPEAKERS 2M

- audio 2x Ø4mm
- to accommodate speaker wire, banana plug Ø4mm or spades
- soldering connection of cable at the back side



1M = 22,5 x 45  
2M = 45 x 45

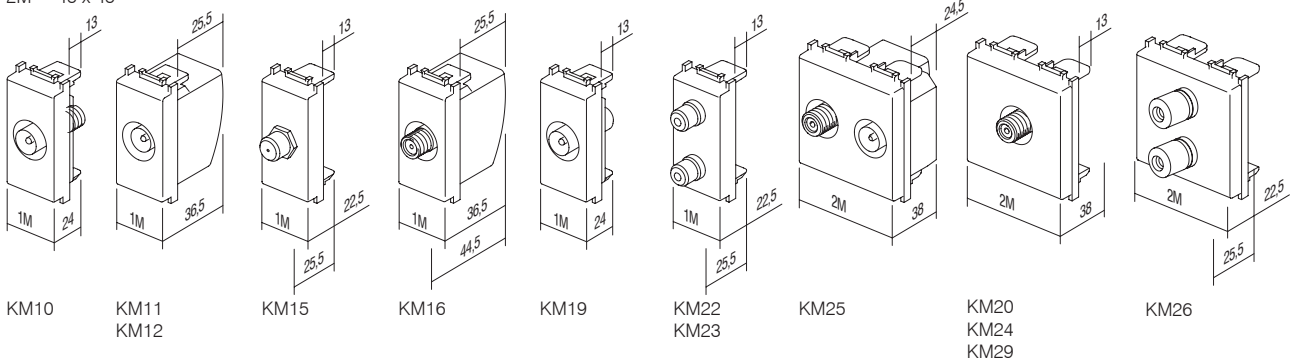

## STECKDOSE TEL LT RJ11 6/4 1M



- KM30PW
- KM30SB
- KM30AT
- KM30ES
- KM30IW

- TEL LT mit Schraubklemmen
- RJ11 6/4
- entspricht IEC 60603-7
- Schraubklemmen

*SOCKET TEL LT RJ11 6/4 1M*

- TEL LT screw
- RJ11 6/4
- in accordance with IEC 60603-7
- screw contacts



## STECKDOSE TEL BT SEC 6/6 1M

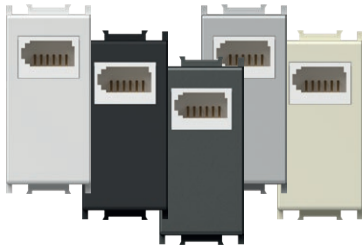

- KM31PW
- KM31SB
- KM31AT
- KM31ES
- KM31IW

- TEL BT britischer Standard
- SEC Sekundär 6/6
- entspricht BS 6312
- Schraubklemmen

*SOCKET TEL BT SEC 6/6 1M*

- TEL BT British standard
- SEC secondary 6/6
- in accordance with BS 6312
- screw contacts



## STECKDOSE TEL KS RJ11 6/4 1M

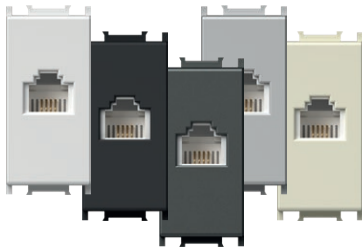

- KM36PW
- KM36SB
- KM36AT
- KM36ES
- KM36IW

- KS – keystone-Befestigungsstandard
- RJ11 6/4
- entspricht IEC 60603-7

*SOCKET TEL KS RJ11 6/4 1M*

- KS keystone fixing standard
- RJ11 6/4
- in accordance with IEC 60603-7



## STECKDOSE CAT5e KS RJ45 8/8 1M

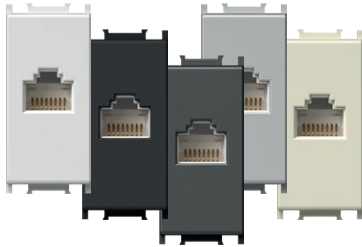

- KM37PW
- KM37SB
- KM37AT
- KM37ES
- KM37IW

- KS – keystone-Befestigungsstandard
- CAT5e, RJ45 8/8
- entspricht IEC 60603-7

*SOCKET CAT5e KS RJ45 8/8 1M*

- KS keystone fixing standard
- CAT5e, RJ45 8/8
- in accordance with IEC 60603-7

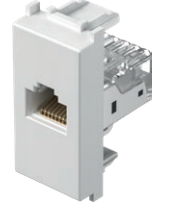

## ADAPTER KS 1M

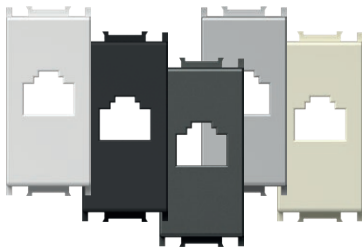

- KM35PW
- KM35SB
- KM35AT
- KM35ES
- KM35IW

- KS – keystone-Befestigungsstandard
- AMP, Avaya, Brandrex, FMT, Mfico, Tyco, ...
- ohne Kommunikationsmodul

*ADAPTER KS 1M*

- KS keystone fixing standard
- AMP, Avaya, Brandrex, FMT, Mfico, Tyco, ...
- communication module not included



## ADAPTER KS MIT STAUBSCHUTZ 1M



- KM38PW
- KM38SB
- KM38AT
- KM38ES
- KM38IW

- KS-keystone-Befestigungsstandard mit Staubschutz
- AMP, Avaya, Brandrex, FMT, Mfico, Tyco, ...
- ohne Kommunikationsmodul

*ADAPTER KS WITH DUST PROTECTION 1M*

- KS keystone fixing standard with dust protection
- AMP, Avaya, Brandrex, FMT, Mfico, Tyco, ...
- communication module not included



STECKDOSE CAT6 RJ45 SCH KS 8/8 1M

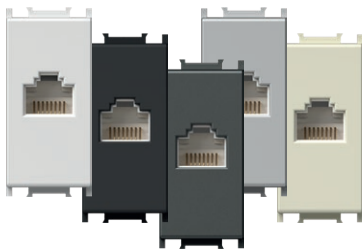

- KM39PW
- KM39SB
- KM39AT
- KM39ES
- KM39IW

- KS Keystone Befestigung Standard  
 - Cat6 UTP werkzeuglos, RJ45 8/8  
 - entspricht ISO / IEC 11801  
**SOCKET CAT6 SCH KS RJ45 8/8 1M**  
 - KS keystone fixing standard  
 - CAT6 UTP toolless, RJ45 8/8  
 - in accordance with ISO/IEC 11801

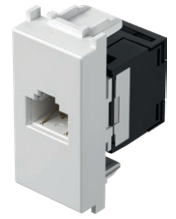

ADAPTER KS UNIVERSAL 1M

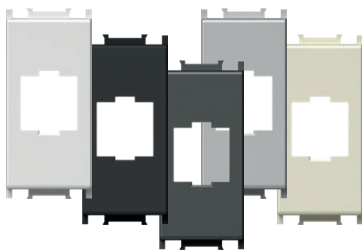

- KM50PW
- KM50SB
- KM50AT
- KM50ES
- KM50IW

- KS – keystone-Befestigungsstandard  
 - geeignet für HDMI, USB  
 - ohne Kommunikationsmodul  
**ADAPTER KS UNIVERSAL 1M**  
 - KS keystone fixing standard  
 - suitable for HDMI, USB  
 - communication module not included

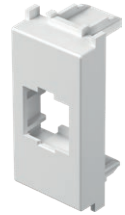

ADAPTER PD 1M

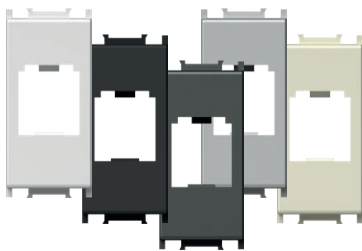

- KM40PW
- KM40SB
- KM40AT
- KM40ES
- KM40IW

- PD Panduit Mini-COM-Befestigungsstandard  
 - ohne Kommunikationsmodul  
**ADAPTER PD 1M**  
 - PD Panduit Mini-COM fixing standard  
 - communication module not included



ADAPTER PD MIT STAUBSCHUTZ 1M



- KM43PW
- KM43SB
- KM43AT
- KM43ES
- KM43IW

- PD – Panduit Mini-COM-Befestigungsstandard mit Staubschutz  
 - ohne Kommunikationsmodul  
**ADAPTER PD WITH DUST PROTECTION 1M**  
 - PD Panduit Mini-COM fixing standard with dust protection  
 - communication module not included



ADAPTER R&M 1M

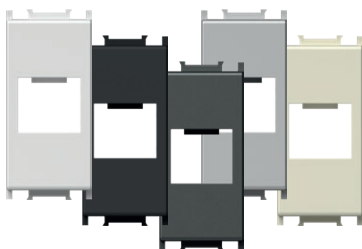

- KM46PW
- KM46SB
- KM46AT
- KM46ES
- KM46IW

- R&M-Befestigungsstandard  
 - ohne Kommunikationsmodul  
**ADAPTER R&M 1M**  
 - R&M fixing standard  
 - communication module not included



ADAPTER R&M CAT6A 1M

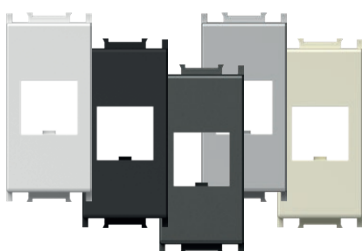

- KM52PW
- KM52SB
- KM52AT
- KM52ES
- KM52IW

- R&M Befestigung für CAT6A  
 - ohne Kommunikationsmodul  
**ADAPTER R&M CAT6A 1M**  
 - R&M fixing for CAT6A  
 - communication module not included



## C O M M U N I C A T I O N S K M



- KM47PW
- KM47SB
- KM47AT
- KM47ES
- KM47IW

**ADAPTER R&M MIT STAUBSCHUTZ 1M**

- R&M-Befestigungsstandard mit Staubschutz
- ohne Kommunikationsmodul

*ADAPTER R&M WITH DUST PROTECTION 1M*

- R&M fixing standard with dust protection
- communication module not included



- KM53PW
- KM53SB
- KM53AT
- KM53ES
- KM53IW

**ADAPTER R&M CAT6A MIT STAUBSCHUTZ 1M**

- R&M Befestigung für CAT6A mit Staubschutzdeckel
- ohne Kommunikationsmodul

*ADAPTER R&M CAT6A WITH DUST PROTECTION 1M*

- R&M fixing for CAT6A with dust protection
- communication module not included



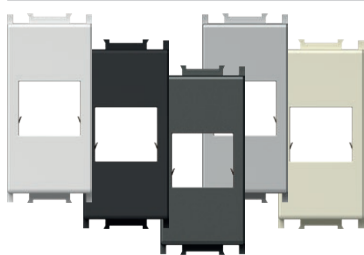

- KM45PW
- KM45SB
- KM45AT
- KM45ES
- KM45IW

**ADAPTER LK 1M**

- LK LeoniKerpen eLine-/BKS NewLine-Befestigungsstandard  
- ohne Kommunikationsmodul

**ADAPTER LK 1M**

- LK LeoniKerpen eLine / BKS NewLine fixing standard  
- communication module not included

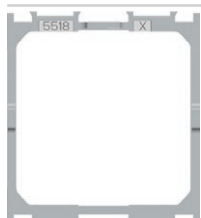

KA26

**ADAPTER NEXANS/SCHRACK 2M**

- Adapter zur Befestigung der Module Nexans LANmark und Schrack in Größe 45 x 45 mm  
- geeignet für Nexans Typ N423.540N  
- geeignet für Schrack Typ HSEMD02W2F  
- ohne Kommunikationsmodul

**ADAPTER NEXANS/SCHRACK 2M**

- fixing adapter for Nexans LANmark and Schrack module 45x45mm  
- suitable for Nexans type N423.540N  
- suitable for Schrack type HSEMD02W2F  
- communication module not included

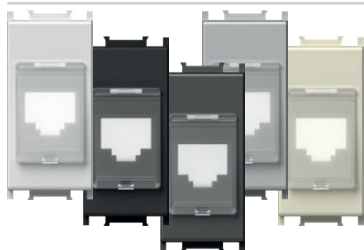
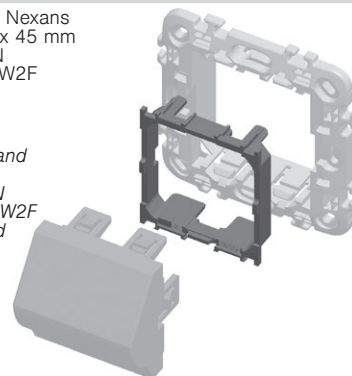

- KM48PW
- KM48SB
- KM48AT
- KM48ES
- KM48IW

**ADAPTER AT&T SYSTEMAX MIT STAUBSCHUTZ 1M**

- AT&T Systemax-Befestigungsstandard mit Staubschutz  
- ohne Kommunikationsmodul

**ADAPTER AT&T SYSTEMAX WITH DUST PROTECTION 1M**

- AT&T Systemax fixing standard with dust protection  
- communication module not included



- KM51PW
- KM51SB
- KM51AT
- KM51ES
- KM51IW

**STECKDOSE USB TYP A 1M**

- USB 2.0 Steckdose Typ A  
- Schraubklemmen, Raster 5 mm, 1,5 mm<sup>2</sup>, 1x2P + 1x3P  
- Verdrahtung:  
PIN 1 - VCC (+5V, roter Leiter)  
PIN 2 - Signal - (weißer Leiter)  
PIN 3 - Signal - (grüner Leiter)  
PIN 4 - GND - Masse (schwarzer Leiter)  
S - Schirm  
- entspricht Richtlinie 2011/95/EU (RoHS2)

**SOCKET USB TYPE A 1M**

- USB 2.0 socket type A  
- screw contacts, raster 5 mm, 1,5 mm<sup>2</sup>, 1x2P + 1x3P  
- wiring:  
PIN 1 - VCC (+5V, red wire)  
PIN 2 - Data - (white wire)  
PIN 3 - Data + (green wire)  
PIN 4 - GND - ground (black wire)  
S - shield  
- in accordance with directive 2011/95/EU (RoHS2)



1M = 22,5 x 45  
2M = 45 x 45

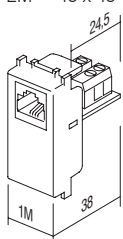

KM30

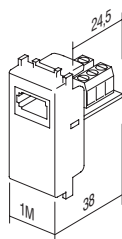

KM31

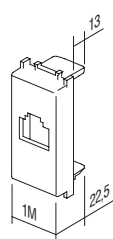

KM35  
KM38  
KM48

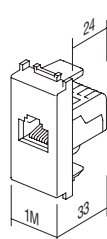

KM36  
KM37  
KM39

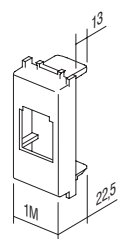

KM40  
KM43

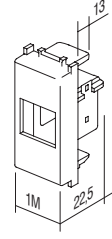

KM45

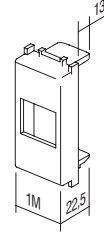

KM46  
KM47  
KM50  
KM52  
KM53

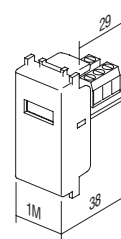

KM51





KA10

Typ <i>type</i>	Bezeichnung <i>description</i>	Technische Daten <i>technical data</i>
KA10	KONNEKTOR KS CAT3 <i>CONNECTOR KS CAT3</i>	RJ11 6/4
KA11	KONNEKTOR KS CAT5e <i>CONNECTOR KS CAT5e</i>	RJ45 8/8
KA12	KONNEKTOR KS CAT5eS <i>CONNECTOR KS CAT5eS</i>	RJ45 8/8
⋮	⋮	⋮



KONNEKTOR KS CAT3 RJ11 6/4	
KA10	<ul style="list-style-type: none"> <li>- KS – keystone-Befestigungsstandard</li> <li>- CAT3, RJ11 6/4</li> <li>- entspricht IEC 60603-7</li> </ul> <p><i>CONNECTOR KS CAT3 RJ11 6/4</i></p> <ul style="list-style-type: none"> <li>- KS keystone fixing standard</li> <li>- CAT3, RJ11 6/4</li> <li>- in accordance with IEC 60603-7</li> </ul>



KONNEKTOR KS CAT5e RJ45 8/8	
KA11	<ul style="list-style-type: none"> <li>- KS – keystone-Befestigungsstandard</li> <li>- CAT5e, RJ45 8/8</li> <li>- entspricht IEC 60603-7</li> </ul> <p><i>CONNECTOR KS CAT5e RJ45 8/8</i></p> <ul style="list-style-type: none"> <li>- KS keystone fixing standard</li> <li>- CAT5e, RJ45 8/8</li> <li>- in accordance with IEC 60603-7</li> </ul>



KONNEKTOR KS CAT5eS RJ45 8/8	
KA12	<ul style="list-style-type: none"> <li>- KS – keystone-Befestigungsstandard</li> <li>- CAT5eS, RJ45 8/8</li> <li>- entspricht IEC 60603-7</li> </ul> <p><i>CONNECTOR KS CAT5eS RJ45 8/8</i></p> <ul style="list-style-type: none"> <li>- KS keystone fixing standard</li> <li>- CAT5eS, RJ45 8/8</li> <li>- in accordance with IEC 60603-7</li> </ul>



KONNEKTOR KS CAT6 SCH RJ45 8/8	
KA15	<ul style="list-style-type: none"> <li>- KS – keystone-Befestigungsstandard</li> <li>- CAT6 UTP toolless, RJ45 8/8</li> <li>- entspricht ISO/IEC 11801</li> </ul> <p><i>CONNECTOR KS CAT6 SCH RJ45 8/8</i></p> <ul style="list-style-type: none"> <li>- KS keystone fixing standard</li> <li>- CAT6 UTP toolless, RJ45 8/8</li> <li>- in accordance with ISO/IEC 11801</li> </ul>



KONNEKTOR KS CAT6S SCH RJ45 8/8	
KA16	<ul style="list-style-type: none"> <li>- KS – keystone-Befestigungsstandard</li> <li>- CAT6S STP toolless, RJ45 8/8</li> <li>- entspricht ISO/IEC 11801</li> </ul> <p><i>CONNECTOR KS CAT6S SCH RJ45 8/8</i></p> <ul style="list-style-type: none"> <li>- KS keystone fixing standard</li> <li>- CAT6S STP toolless, RJ45 8/8</li> <li>- in accordance with ISO/IEC 11801</li> </ul>



KONNEKTOR KS CAT6a SCH RJ45 8/8	
KA17	<ul style="list-style-type: none"> <li>- KS – keystone-Befestigungsstandard</li> <li>- CAT6a STP toolless, RJ45 8/8</li> <li>- entspricht ISO/IEC 11801</li> </ul> <p><i>CONNECTOR KS CAT6a SCH RJ45 8/8</i></p> <ul style="list-style-type: none"> <li>- KS keystone fixing standard</li> <li>- CAT6a STP toolless, RJ45 8/8</li> <li>- in accordance with ISO/IEC 11801</li> </ul>



KA18

---

**KONNEKTOR SLIM KS CAT6S SCH RJ45 8/8**

- KS – Keystone-Befestigungsstandard
- Slim-Ausführung
- CAT6S STP toolless, RJ45 8/8
- entspricht ISO/IEC 11801
- auch für die Verwendung als Doppeladapter KE46 geeignet

*CONNECTOR SLIM KS CAT6S SCH RJ45 8/8*

- KS keystone fixing standard
- slim style
- CAT6S STP toolless, RJ45 8/8
- in accordance with ISO/IEC 11801
- suitable also for KE46 double adapter



KA27

---

**KONNEKTOR KS HDMI**

- KS – keystone-Befestigungsstandard
- nur in Kombination mit Adapter KM50
- HDMI/HDMI

*CONNECTOR KS HDMI*

- KS keystone fixing standard
- only in combination with adapter KM50
- HDMI/HDMI



KA28

---

**KABEL KS HDMI**

- KS – keystone-Befestigungsstandard
- nur in Kombination mit Adapter KM50
- HDMI/HDMI

*CABLE KS HDMI*

- KS keystone fixing standard
- only in combination with adapter KM50
- HDMI/HDMI

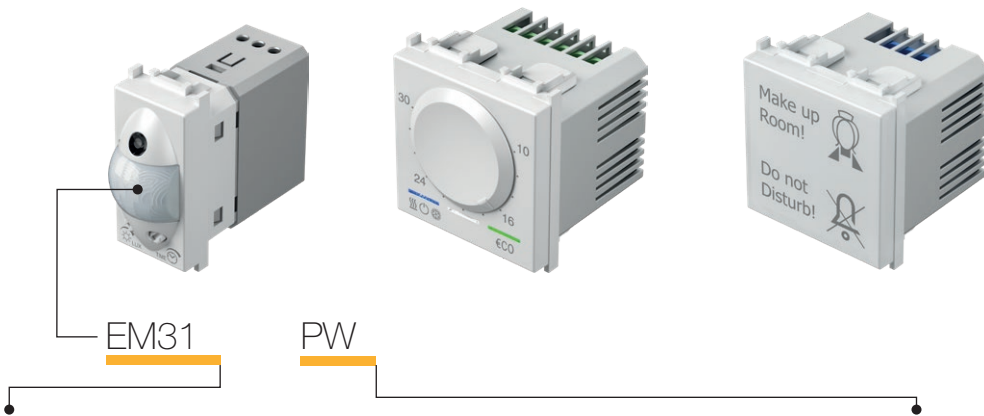

Typ type	Bezeichnung description	Technische Daten technical data	Größe size	Farbe colour
EM10	DIMMER DREH-AUS <i>DIMMER ROTATIVE</i>	R 300W	1M	<input type="checkbox"/> PW weiß-glänzend <i>polar white</i>
EM12	DIMMER DREH-WECHSEL <i>DIMMER ROTATIVE 2WAY</i>	RL 300W	1M	<input checked="" type="checkbox"/> SB schwarz-matt <i>soft touch black</i>
EM23	DIMMER EINBAU <i>DIMMER INBOX</i>	RC,RL 200VA	/	<input checked="" type="checkbox"/> AT anthrazit <i>anthracite</i>
⋮	⋮	⋮	⋮	<input type="checkbox"/> ES silber-matt <i>elox silver</i>
⋮	⋮	⋮	⋮	<input type="checkbox"/> IW beige-glänzend <i>ivory white</i>
⋮	⋮	⋮	⋮	<input type="checkbox"/> BL blau <i>blue</i>
⋮	⋮	⋮	⋮	<input type="checkbox"/> RD rot <i>red</i>
⋮	⋮	⋮	⋮	<input type="checkbox"/> GR grün <i>green</i>
⋮	⋮	⋮	⋮	<input type="checkbox"/> OR orange <i>orange</i>
⋮	⋮	⋮	⋮	<input type="checkbox"/> RG rot/grün <i>red/green</i>

**DIMMER DREH-AUS R 300W 1M**



- EM10PW
- EM10SB
- EM10AT
- EM10ES
- EM10IW

- Dreh-Aus
- Typ RTS34.43 RVP, Belastung R, 40W - 300W
- Versorgung 230 V<sup>~</sup> 50 Hz
- kann nicht mit Wechselschalter verbunden werden
- Verbindung von zwei Dimmern ist nicht gestattet
- entspricht EN 60669-1
- Schraubklemmen 1,5-2,5 mm<sup>2</sup>
- LED-Kontrollbeleuchtung



**DIMMER ROTATIVE R 300W 1M**

- rotation control without switch
- type RTS34, 43 RVP, load R, 40W - 300W
- supply voltage 230V<sup>~</sup> 50Hz
- 2-way switch combination is not possible
- more dimmers combination is not allowed
- in accordance with EN 60669-1
- screw contacts 1.5-2.5mm<sup>2</sup>
- LED indication

**DIMMER DREH-WECHSEL RL 300 W 1M**



- EM12PW
- EM12SB
- EM12AT
- EM12ES
- EM12IW

- Dreh-Wechsel
- Belastung RL, 40W - 300W
- Versorgung 230 V<sup>~</sup> 50 Hz
- kann mit Wechselschalter verbunden werden
- die Montage von mehreren Geräten in eine Dose kann nur unter der Voraussetzung erfolgen, dass deren maximale Gesamtleistung nicht die maximale Leistung eines Dimmers überschreitet
- in einem Stromkreis kann nur ein Dimmer verwendet werden
- es ist keine Sicherung eingebaut - verwenden Sie eine externe Sicherung
- entspricht EN 60669-1
- Schraubklemmen 1,5-2,5 mm<sup>2</sup>
- integrierte LED-Kontrollbeleuchtung für den Dimmungspegel



**DIMMER ROTATIVE/2WAY RL 300W 1M**

- rotation control with 2-way switch
- load RL, 40W - 300W
- supply voltage 230V<sup>~</sup> 50Hz
- 2-way switch combination is possible
- installing several devices together in one box is only permitted if their total maximum load does not exceed the maximum power of a single dimmer
- one circuit allows the use of only one dimmer
- no built-in fuse - external fuse must be used
- in accordance with EN 60669-1
- screw contacts - 1.5-2.5mm<sup>2</sup>
- integrated LED indication of dimming level



- EM13PW
- EM13SB
- EM13AT
- EM13ES
- EM13IW

#### DIMMER DREH-WECHSEL LED 60 W 1M

- Dreh-Wechsel
- Belastung:
  - LED, 0–60 W (max. 6 dimmbare LED-Lampen)
  - GLS, 0–60 W
- Versorgung 230 V $\sim$  50 Hz
- kann mit Wechselschalter verbunden werden
- die Montage von mehreren Geräten in eine Dose kann nur unter der Voraussetzung erfolgen, dass deren maximale Gesamtleistung nicht die maximale Leistung eines Dimmers überschreitet
- in einem Stromkreis kann nur ein Dimmer verwendet werden
- es ist keine Sicherung eingebaut – verwenden Sie eine externe Sicherung
- entspricht IEC60669-2-1
- Schraubklemmen 1,5–2,5 mm<sup>2</sup>

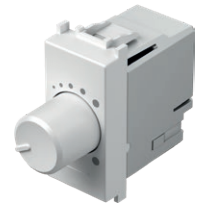

#### DIMMER ROTATIVE/2WAY LED 60W 1M

- rotation control with 2-way switch
- loads: LED, 0 – 60W (max. 6 dimmable LED lamps)
- GLS, 0 – 60W
- supply voltage 230V $\sim$  50Hz
- 2-way switch combination is possible
- installing several devices together in one box is only permitted if their total maximum load does not exceed the maximum power of a single dimmer
- one circuit allows the use of only one dimmer
- no built-in fuse – external fuse must be used
- in accordance with IEC60669-2-1
- screw contacts - 1.5-2.5mm<sup>2</sup>



- EM14PW
- EM14SB
- EM14AT
- EM14ES
- EM14IW

#### DIMMER DREH-WECHSEL LED 180 W

- Dreh-Wechsel
- Belastung:
  - LED, 0–180 W (max. 20 dimmbare LED-Lampen)
  - GLS, 0–180 W
- Versorgung 230 V $\sim$  50 Hz
- kann mit Wechselschalter verbunden werden
- die Montage von mehreren Geräten in eine Dose kann nur unter der Voraussetzung erfolgen, dass deren maximale Gesamtleistung nicht die maximale Leistung eines Dimmers überschreitet
- in einem Stromkreis kann nur ein Dimmer verwendet werden
- es ist keine Sicherung eingebaut – verwenden Sie eine externe Sicherung
- entspricht IEC60669-2-1
- Schraubklemmen 1,5–2,5 mm<sup>2</sup>

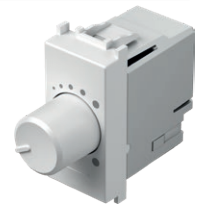

#### DIMMER ROTATIVE/2WAY LED 180W 1M

- rotation control with 2-way switch
- loads:
  - LED, 0 – 180W (max. 20 dimmable LED lamps)
  - GLS, 0 – 180W
- supply voltage 230V $\sim$  50Hz
- 2-way switch combination is possible
- installing several devices together in one box is only permitted if their total maximum load does not exceed the maximum power of a single dimmer
- one circuit allows the use of only one dimmer
- no built-in fuse – external fuse must be used
- in accordance with IEC60669-2-1
- screw contacts - 1.5-2.5mm<sup>2</sup>



- EM15PW
- EM15SB
- EM15AT
- EM15ES
- EM15IW

#### DIMMER DREH-AUS R 250W 1M

- Dreh-Aus
- Typ RTS34.43 RVP, Belastung R, 40W - 250W
- Versorgung 230 V $\sim$  50 Hz
- kann nicht mit Wechselschalter verbunden werden
- Verbindung von zwei Dimmern ist nicht gestattet
- entspricht EN 60669-1
- Schraubklemmen 1,5–2,5 mm<sup>2</sup>
- LED-Kontrollbeleuchtung

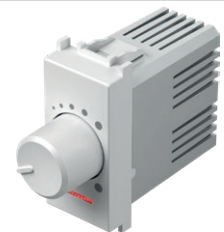

#### DIMMER ROTATIVE R 250W 1M

- rotation control without switch
- type RTS34, 43 RVP, load R, 40W - 250W
- supply voltage 230V $\sim$  50Hz
- 2-way switch combination is not possible
- more dimmers combination is not allowed
- in accordance with EN 60669-1
- screw contacts 1.5-2.5mm<sup>2</sup>
- LED indication



EM23

**EINBAUDIMMER R (250 W), (RC,RL 200VA)**

- für den Einbau, in Verbindung mit Taster
- Belastung RLC 15-250W oder 15-200 VA
- Versorgung 230 V $\sim$  50Hz
- kann mit mehreren Tastern verbunden werden
- Verbindung von mehreren Dimmern ist nicht gestattet
- Speicherfunktion integriert
- Soft-Ein/-Aus-Funktion
- »leading edge«
- Entspricht EN60669, EN60950, EN 61000, ETSI EN 300 220-1, ETSI EN 300 220-2
- Schraubklemmen für Durchmesser bis 2,5mm<sup>2</sup>

**DIMMER INBOX R (250 W), (RC, RL 200 VA)**

- *inbox, controlled by external push button*
- *load RLC 15-250W or 15-200 VA*
- *supply voltage 230V $\sim$  50HZ*
- *several push-buttons combinations are possible*
- *more dimmers combination is not allowed*
- *light intensity memory*
- *soft start/stop function*
- *»leading edge«*
- *in accordance with EN60669, EN60950, EN 61000, ETSI EN 300 220-1, ETSI EN 300 220-2*
- *screw contacts to wires 2,5 mm<sup>2</sup>*



EM18

**DIMMER EINBAU LED 250W**

- für den Einbau, in Verbindung mit Taster
- Vorder- oder Hinterkante
- Versorgung 230 V $\sim$  50 Hz
- kann mit mehreren Tastern verbunden werden
- Speicherfunktion integriert
- Soft-Ein/Aus-Funktion
- Einstellung der minimalen Helligkeit
- Montage nur eines Gerätes in eine Dose
- nur für Gebrauch im Innenbereich
- entspricht EN 60669-1 und EN 60669-2-1

**DIMMER INBOX LED 250W**

- *inbox, controlled by external push button*
- *for leading or trailing edge*
- *supply voltage 230V $\sim$  50Hz*
- *several push-buttons combinations is possible*
- *light intensity memory*
- *soft start / stop function*
- *minimum intensity control*
- *only one dimmer per wall box*
- *only for indoor usage*
- *in accordance with EN 60669-1 and EN 60669-2-1*



EM19

**DIMMER EINBAU DC LED 96W**

- für den Einbau, in Verbindung mit Taster
- Anschluss mit allen Konstantspannung-LED-Netzteilen und einigen Konstantstrom-LED-Netzteilen, 9- 48 V DC, maximal 96 W
- nicht für induktive Lasten geeignet
- kann mit mehreren Tastern und Dimmern verbunden werden
- Speicherfunktion integriert
- Soft-Ein/Aus-Funktion
- Montage nur eines Gerätes in eine Dose
- nur für Gebrauch im Innenbereich

**DIMMER INBOX DC LED 96W**

- *inbox, controlled by external push button*
- *for use with constant voltage LED drivers and some constant current LED drivers, 9-48V DC, max 96W (also for LED strips)*
- *not for use with inductive loads*
- *several push-buttons combinations and several dimmers is possible*
- *light intensity memory*
- *soft start / stop function*
- *only one dimmer per wall box*
- *only for indoor usage*

EM10 (40÷300W)  
EM15 (40÷300W)

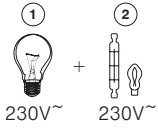

EM12 (40÷300W)

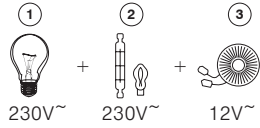

EM13 (0÷60W), EM14 (0÷180W),  
EM23 (15÷250W, 15÷200VA),  
EM18 (2÷250VA (3=10÷250VA), 2÷250W)

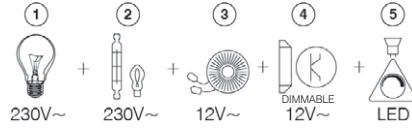

- 1 - Glühlampe / incandescent lamp
- 2 - Halogenlampe / halogen lamp
- 3 - Klassischer Transformator / classical transformer
- 4 - Dimmbarer elektronischer Transformator / dimmable electronic transformer
- 5 - Dimmbare LED-Lampe / dimmable LED lamp

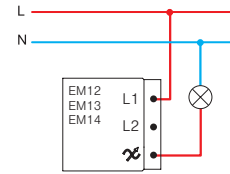
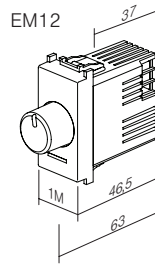
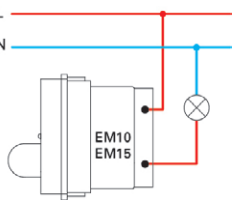
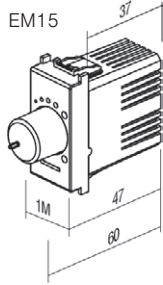
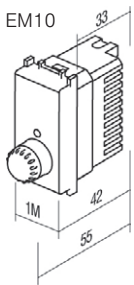

EM23

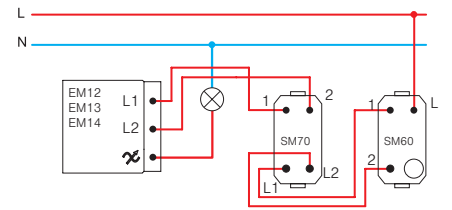
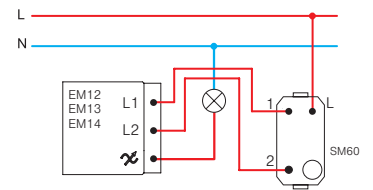
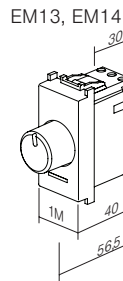
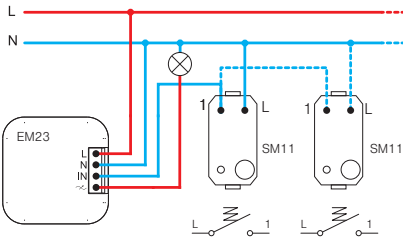
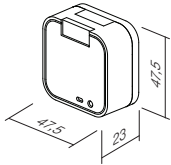

EM18

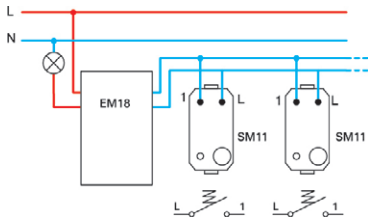
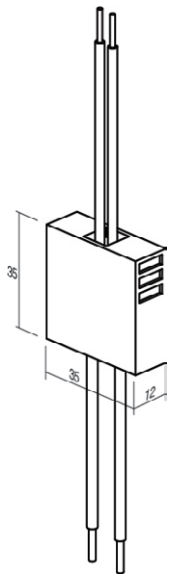

EM19

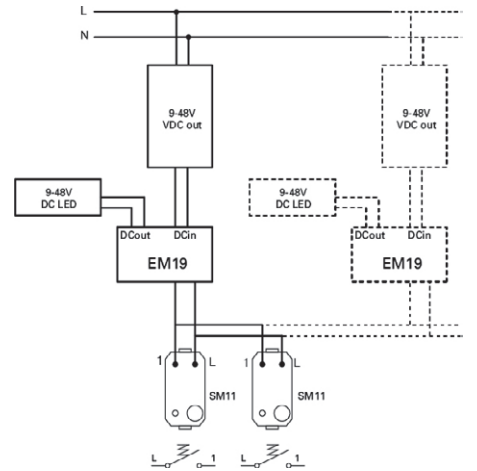
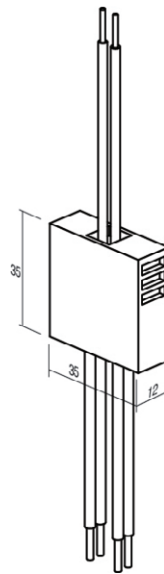

**VORSICHT!**

Bei der Montage von mehreren Dimmern in einer Dose verringert sich die maximale Gesamtleitung um 10 % für jeden zusätzlichen Dimmer.

**ATTENTION!**

If more dimmers are connected in one box reduce maximum common power for 10% for each dimmer.

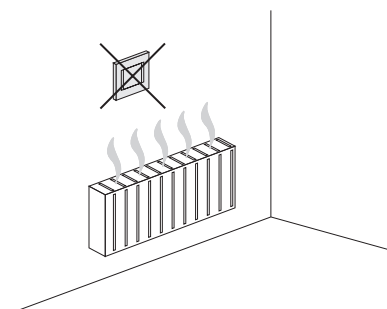

SCHALTER/DIMMER UNIVERSAL RLC 0-300W 2M



- EM25PW
- EM25SB
- EM25AT
- EM25ES
- EM25IW

- Elektronischer Universaldimmer zum Ein-/Ausschalten und Dimmen von allen dimmbaren Lampen und Leuchtmitteln (klassische, Halogenlampen, LED, CFL usw.) und einigen nicht dimmbaren Leuchtmitteln.
- erkennt automatisch den Lampentyp und passt entsprechend die Betriebsart an
- durch die Verdunkelung verringert sich der Stromverbrauch
- die Soft-Ein/Aus-Funktion verlängert die Lebensdauer der Lampen
- Regelung über integrierte Mikroschalter
- Speicherfunktion integriert (speichert den Dimmwert beim Ausschalten)
- Schaltung von bis zu fünf (5) zusätzlichen Kontrollschalter EM26 möglich
- kann nicht mit Wechselschalter verbunden werden
- integrierter Kurzschluss-, Überhitzungs- und Überlastungsschutz
- Versorgung 230 V~ 50 Hz
- hochelegante LED für Beleuchtung, mit Einstellmöglichkeit (Farbe und Intensität)
- Wechselmöglichkeit für klassische Schalter – Zweileiterschaltung (1)
- die volle Funktionalität des Dimmers wird durch die Dreileiterschaltung erreicht
- entspricht EN 60669-1 und EN 60669-2-1
- Schraubklemmen 1,5 mm<sup>2</sup> (max. Kraft zum Festziehen der Schrauben 0,4 Nm)



TOUCH EM25 ist ein Mikroprozessor-Gesteuerter elektronischer Dimmer. Es ermöglicht das Ein-/Ausschalten und Dimmen von allen dimmbaren und einigen nicht dimmbaren Lampen und Leuchtmitteln. Der eingebaute Mikroprozessor erkennt automatisch den Lampentyp und passt entsprechend die Betriebsart an. Die integrierte Speicherfunktion ermöglicht beim Ausschalten des Dimmers die Speicherung der letzten Einstellung. Die Soft-Ein-/Aus-Funktion verlängert die Lebensdauer der Lampen. In der Dimmertaste ist eine hochelegante LED zur Beleuchtung mit verschiedenen Einstellungsmöglichkeiten (Farbe und Intensität) integriert. Schaltung von bis zu 5 zusätzlichen Kontrollschalter EM26 möglich (»Slave«).

TOUCH EM25 is microprocessor controlled electronic light dimmer. It serves as switch and dimmer for dimmable and some of non-dimmable lamps. Integrated microprocessor automatically identifies the type of lamp and adjusts the operating mode. It remembers the level of dimming after switching off due to integrated memory function. Soft-start function extends the lamp service life. In button integrated elegant LED illumination enables many different colours and intensity levels. Optionally one can connect up to 5 additional control tasters EM26 (»slave«).

SWITCH / DIMMER UNIVERSAL RLC 0-300W 2M

- universal electronic dimmer for ON/OFF switching and dimming of all dimmable lamps (classical, halogen, LED, CFL, ...) and some non-dimmable lamps
- automatic detection of lamp type and adjustment of operating mode
- reduction of energy consumption
- soft start function extends life of lamps
- controlled by build-in micro switches
- memory function included – memorizes brightness on turn-off
- up to five (5) additional control units EM26 can be connected
- connection with 2-way switch is not possible
- build-in short-circuit, overheating and overload protection
- supply voltage 230V~ 50Hz
- elegant LED illumination, adjustable colour and brightness
- replacement of classical switch is possible at two-wire connection<sup>(1)</sup>
- full functionality is achieved at three-wire connection<sup>(2)</sup>
- in accordance with EN 60669-1 and EN 60669-2-1
- screw contacts 1.5mm<sup>2</sup> (max. tightening torque 0.4Nm)

<sup>(1)</sup>Zweileiterschaltung  
two-wire connection

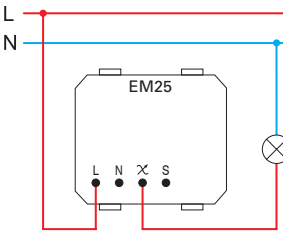

- die Zweileiterschaltung ermöglicht das Dimmen von dimmbaren Lampen und Leuchtmitteln.
- two-wire connection allows dimming of dimmable lamps

<sup>(2)</sup>Dreileiterschaltung  
three-wire connection

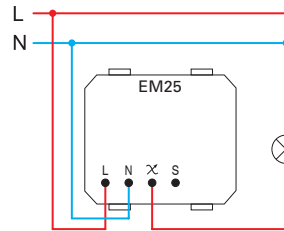

- die Dreileiterschaltung ermöglicht das Dimmen von dimmbaren Lampen und Leuchtmitteln und einigen nicht dimmbaren LED- und CFL-Lampen.
- three-wire connection allows dimming of dimmable lamps and some of non-dimmable LED and CFL lamps

	1	2	5	6	7
Min.	40 W	40 W	40 VA	40 VA	40 VA
Max.	300 W	300 W	300 VA	100 VA	100 VA
	(F)	(F)	(F)		

	1	2	4	6	7	8	9
Min.	0 W	0 W	0 VA	0 VA	0 VA	0 VA	0 VA
Max.	300 W	300 W	120 VA	120 VA	120 VA	120 VA	120 VA
	(F)	(F)	(F)			(F)	(F)

1 – Glühlampe / incandescent lamp

2 – Halogenlampe / halogen lamp

4 – dimmbarer elektronischer Transformator / dimmable electronic transformer

5 – klassischer Transformator / classical transformer

6 – dimmbare Energiesparlampe CFL / dimmable energy saving CFL lamp









7 – dimmbare LED-Lampe / dimmable LED lamp

8 – nicht dimmbare Energiesparlampe CFL / non-dimmable energy saving CFL lamp

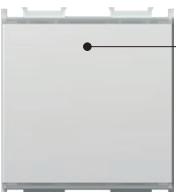
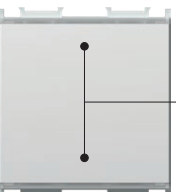
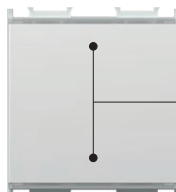
9 – nicht dimmbare LED-Lampe / non-dimmable LED lamp

Anmerkungen / remarks

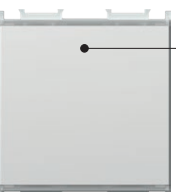
- (F) Filter EM27
- Wir empfehlen die Verwendung eines Filters EM27 / it is recommended to use filter EM27
- Alle gesteuerten Lampen und Leuchtmittel müssen gleich sein / all controlled lamps must be the same
- Die Belastungstabelle gilt für Lampen mit Faktor PF > 0,5 / table of loads is valid for lamps with power factor PF>0.5

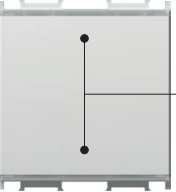
<p>Ein-/Ausschalten und Dimmen der Lichter / on / off swithcing and dimming of lamp</p>	<p>Farbauswahl und Einstellung der LED-Beleuchtungsintensität / LED colour selection and intensity level adjustment</p>	<p>*RESET-Funktion* / "RESET" function</p>
 <p>Ein/Ausschalten kurzes Drücken on / off short press</p>	 <p>Ausschalten der Lichter kurzes Drücken lamp off short press</p>	 <p>Ausschalten der Lichter kurzes Drücken lamp off short press</p>
 <p>Beleuchtung längeres Drücken dimming up long press</p>	 <p>gleichzeitiges Drücken ~ 3s die integrierte Lampe blinkt 3x simultaneous press ~ 3s integrated LED blinks 3 times</p>	 <p>gleichzeitiges Drücken ~ 3s die integrierte Lampe blinkt 3x simultaneous press ~ 3s integrated LED blinks 3 times</p>
 <p>Dimmen längeres Drücken dimming down long press</p>	  <p>Farbauswahl kurzes Drücken colour selection short press</p>	 <p>erneutes gleichzeitiges Drücken ~ 5 s die integrierte Lampe blinkt 5x re-simultaneous press ~ 5s integrated LED blinks 5 times</p>
	 <p>Beleuchtung der integrierten LED längeres Drücken integrated LED dimming up long press</p>	<p>* - wir empfehlen beim Einbau des Dimmers und beim Wechsel der Lampen und Leuchtmittel diese Funktion durchzuführen - unbedingt notwendig bei Verwendung von nicht dimmbaren Lampen - die RESET-Funktion ist bei der Zweileiterschaltung nicht anwendbar - nur bei EM25 möglich  - it is recommended at dimmer installation and lamp replacement - mandatory when using non-dimmable lamps - "RESET" function is not possible when using two-wire connection - only possible on EM25</p>
	  <p>Dimmen der integrierten LED längeres Drücken integrated LED dimming down long press</p>	
	 <p>Einstellungen speichern – gleichzeitiges kurzes Drücken die integrierte Lampe blinkt 3x settings saving - simultaneous short press integrated LED blinks 3 times</p>	

Einbauhinweise /  
installation precautions

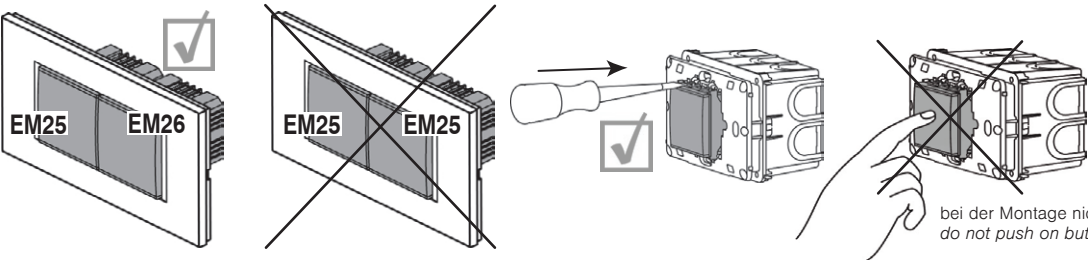

bei der Montage nicht die Taste betätigen/  
do not push on button during mounting



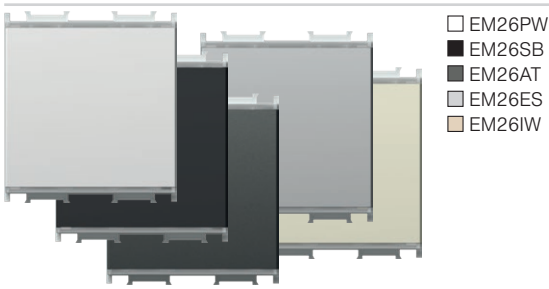

- EM26PW
- EM26SB
- EM26AT
- EM26ES
- EM26IW

**KONTROLLTASTER 2M**

- in Verbindung mit dem Universaldimmer EM25 ermöglicht dieser Taster die Bedienung der Beleuchtung aus mehreren (bis zu 5) Standorten mit der gleichen Funktionalität als EM25
- Versorgung 230 V $\sim$  50 Hz
- entspricht EN 60669-1 und EN 60669-2-1
- Schraubklemmen 1,5 mm<sup>2</sup> (max. Kraft zum Festziehen der Schrauben 0,4 Nm)



**PUSH-BUTTON CONTROL UNIT 2M**

- connected to universal dimmer EM25 allows controlling of lamps with same functionality as EM25
- supply voltage 230V $\sim$  50Hz
- in accordance with EN 60669-1 and EN 60669-2-1
- screw contacts 1.5mm<sup>2</sup> (max. tightening torque 0.4Nm)

<sup>(1)</sup>Zweileiterschaltung  
two-wire connection

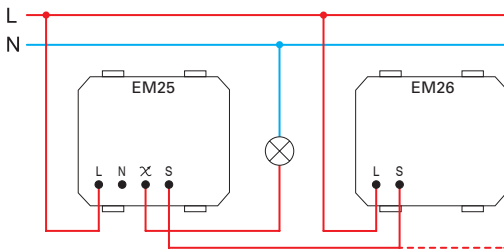

- die Zweileiterschaltung ermöglicht das Dimmen von dimmbaren Lampen und Leuchtmitteln.
- im Falle der Zweileiterschaltung wird durch jeden zusätzlichen Kontrolltaster die Minimalbelastung um 25 W vergrößert.
- two-wire connection allows dimming of dimmable lamps
- in a two-wire connection each additional control unit increases the minimum load by 25W

<sup>(2)</sup>Dreileiterschaltung  
three-wire connection

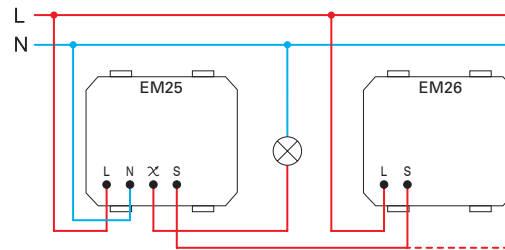

- die Dreileiterschaltung ermöglicht das Dimmen von dimmbaren Lampen und Leuchtmitteln und einigen nicht dimmbaren LED- und CFL-Lampen.
- three-wire connection allows dimming of dimmable lamps and some of non-dimmable LED and CFL lamps

**STÖRUNGSFILTER**



EM27

- Filter für Frequenzstörungen für EM25 L
- die Abbildung ist symbolisch

**FREQUENCY FILTER**

- frequency filter for EM25
- image is symbolic

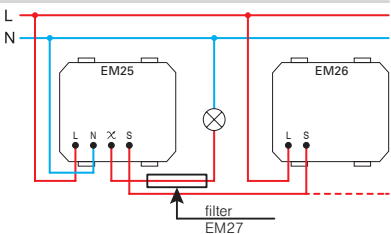

**SET SCHALTER/DIMMER UNIVERSAL RLC 0-300W 2M PP OL20**

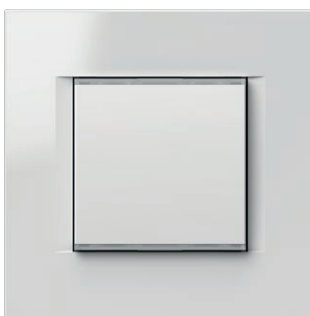

□ EM25PPOL20

- Set aus Dimmer EM25, Montageträger 2M und Rahmen LINE 2M PW
- siehe technische Beschreibung EM25

**SET SWITCH / DIMMER UNIVERSAL RLC 0-300W 2M PP OL20**

- set includes dimmer EM25, mounting frame 2M and cover plate LINE 2M PW
- for technical details see EM25



2M = 45 x 45

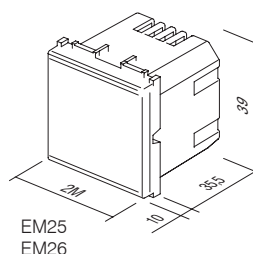

EM25  
EM26



- EM31PW
- EM31SB
- EM31AT
- EM31ES
- EM31IW

IR-SCHALTER 5A 230V~ 1M

- IR-Schalter
- Versorgung: 230V~ ±10 % 50Hz
- Relais: 5A / 250V~ Ausgang mit hochohmigen Strombegrenzung für den Nulldurchgang
- Schutzart: IP40
- Schraubklemmen: 0,75–2,5 mm<sup>2</sup>
- Erfassungswinkel: bis 110° bei 20°C
- Erfassungsbereich: ca. 8 m bei 20°C
- Einstellung der Beleuchtungszeit: von ca. 5 s bis 12 min
- Beleuchtungseinstellung: von ca. 5 bis 200 Lx
- Betriebstemperatur: von 0°C bis +40°C
- nicht geeignet für den Einbau in Dosen mit Tiefe 45 mm und Gehäuse CUBO IP20
- nur für Gebrauch im Innenbereich



IR SWITCH 5A 230V~ 1M

- IR infrared switch
- supply voltage: 230V~ ±10 % 50Hz
- relay: 5A / 250V~ output for limited current with high resistance for zero crossing
- protection rating: IP40
- cross-section of wires at the contact terminal: 0.75 - 2.5 mm<sup>2</sup>
- detection angle: up to 110° at 20°C
- detection area: approx. 8 m at 20°C
- adjustability of duration: from approx. 5 s to 12 min
- adjustability of brightness: from approx. 5 to 200 LUX
- operating temperature: from 0°C to +40°C
- not suitable for installation in 45 mm deep boxes and surface mount box CUBO IP20
- only for indoor usage



- EM32PW
- EM32SB
- EM32AT
- EM32ES
- EM32IW

IR-SCHALTER 5A 230V~ 2M

- IR-Schalter
- Versorgung: 230V~ ±10 % 50Hz
- Relais: 5A / 250V~ Ausgang mit hochohmigen Strombegrenzung für den Nulldurchgang
- Schutzart: IP40
- Schraubklemmen: 0,75–2,5 mm<sup>2</sup>
- Erfassungswinkel: bis 110° bei 20°C
- Erfassungsbereich: ca. 8 m bei 20°C
- Einstellung der Beleuchtungszeit: von ca. 5 s bis 12 min
- Beleuchtungseinstellung: von ca. 5 bis 200 Lx
- Betriebstemperatur: von 0°C bis +40°C
- nicht geeignet für den Einbau in Dosen mit Tiefe 45 mm und Gehäuse CUBO IP20
- nur für Gebrauch im Innenbereich



IR SWITCH 5A 230V~ 2M

- IR infrared switch
- supply voltage: 230V~ ±10 % 50Hz
- relay: 5A / 250V~ output for limited current with high resistance for zero crossing
- protection rating: IP40
- cross-section of wires at the contact terminal: 0.75 - 2.5 mm<sup>2</sup>
- detection angle: up to 110° at 20°C
- detection area: approx. 8 m at 20°C
- adjustability of duration: from approx. 5 s to 12 min
- adjustability of brightness: from approx. 5 to 200 LUX
- operating temperature: from 0°C to +40°C
- not suitable for installation in 45 mm deep boxes and surface mount box CUBO IP20
- only for indoor usage

Erfassungsbereich/  
detection range

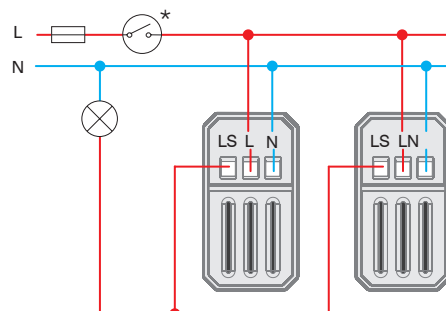
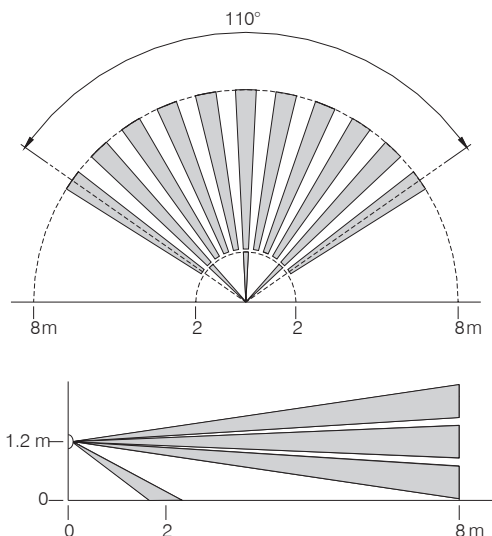

Einstellung der Lichtempfindlichkeit und der Beleuchtungszeit/  
time and twilight adjustment

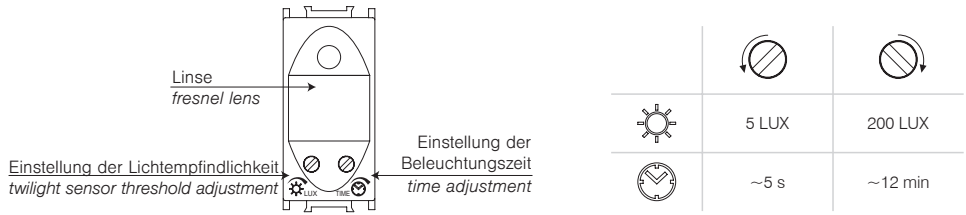

	1	2	3	4	5	6	7	8
Min.	1 W	1 W		1 VA	1 W	1 W	1 VA	1 VA
Max.	800 W	800 W	5A	6x20 VA	6x36 W	4x36 W (20µF)	6x23 VA	6x20 VA

1 - Glühlampe / incandescent lamp

2 - Halogenlampe / halogen lamp

3 - Widerstandsheizelement / resistive heating element

4 elektronischer Transformator / electronic transformer

5 - Leuchtstoffröhre (Ausführung 1) / fluorescent tube (version 1)

6 - Leuchtstoffröhre (Ausführung 2) / fluorescent tube (version 2)

7 - Energiesparlampe CFL / energy saving CFL lamp

8 - LED-Lampe / LED lamp

Hinweise / attention

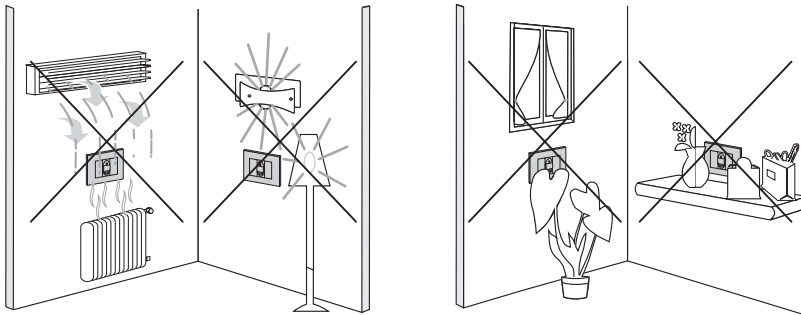

1M = 22,5 x 45

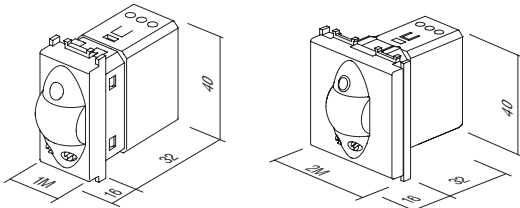

ELEKTRONISCHES THERMOSTAT 6A 250V~ 2M



- EM37PW
- EM37SB
- EM37AT
- EM37ES
- EM37IW



Das Thermostat ist zur Regulierung der Raumtemperatur bestimmt. Es ermöglicht zwei Betriebsarten – Heizung und Kühlung. Das Thermostat ist mit zwei Schutzfunktionen ausgestattet – Frostschutz (Betriebsart Heizung) und Überhitzungsschutz (Betriebsart Kühlung) und einer LED-Betriebsanzeige. Die Einstellung erfolgt durch Drehen des Drehknopfes zur Temperatureinstellung und durch Betätigung der kapazitiven Berührungstasten.

The thermostat is intended for regulating temperature in a room. A thermostat enables two modes of operation – heating or cooling. It has safety functions installed for protection against freezing (heating mode) and protection against overheating (cooling mode). The operation is indicated via LED lights. Thermostat setup is performed with the help of a rotary button for setting the temperature and with other capacitive touch buttons.

- elektronisches Thermostat
- Betriebsart: Heizung / Kühlung / Aus
- Versorgung: 230 VAC, 50 Hz
- Ausgang: 6(2) A, 230 VAC, Umschaltrelais
- Regulierungsbereich: +10 °C bis +30 °C
- Hysterese: ±0.5 °C, ED = 20min
- Frostschutz (Betriebsart Heizung): + 6 °C
- Überhitzungsschutz (Betriebsart Kühlung): + 32 °C
- ECO-Funktion zur Temperaturensenkung um 3 °C für 6 Stunden in der Betriebsart Heizung und Temperaturerhöhung um 3 °C für 6 Stunden in der Betriebsart Kühlung
- jeden Tag erfolgt um die gleiche Zeit automatisch eine Temperaturreduzierung für 3 °C für 6 Stunden in Betriebsart Heizung oder eine Temperaturerhöhung für 3 °C für 6 Stunden in Betriebsart Kühlung
- Möglichkeit zum externen Einschalten der ECO-Betriebsart über einen separaten Eingang
- LED-Betriebsanzeige
- nicht geeignet für elektrische Fußbodenheizung
- Schraubklemmen max. 2,5 mm<sup>2</sup>
- entspricht der LV- und EMC-Richtlinie sowie EN60730-1 und EN60730-2-9
- zur korrekten Funktion empfehlen wir den Einbau in eine separate Dose, getrennt von Wärme erzeugenden Geräten
- Anwendungstemperatur: 5–35 °C
- Lagertemperatur: –20 bis 50 °C

THERMOSTAT BASIC 6A 230 V ~ 2M

- electronic thermostat, basic
- operation mode: heating/cooling/turn off
- power supply: 230 VAC, 50 Hz
- output: 6(2) A, 230 VAC, relay switch
- regulation range: +10 °C to +30 °C
- hysteresis: ±0.5 °C, ED = 20min
- anti-freeze protection (heating mode): +6 °C
- overheating protection (cooling mode): +32 °C
- ECO function for lowering the temperature by 3 °C for 6 hours in the heating mode and raising temperature by 3 °C for 6 hours in the cooling mode
- adaptive ECO function, automatically every day at the same time lowers the temperature by 3 °C for 6 hours in the heating mode and raises temperature by 3 °C for 6 hours in the cooling mode
- option to turn on the ECO operating mode by external trigger via a separate input
- LED indication of operation
- not suitable for electrical floor heating
- screw contacts max. 2.5 mm<sup>2</sup>
- in accordance with the LV Directive, the EMC Directive, standards EN60730-1 and EN60730-2-9
- for correct operation, we recommend installing in an independent single box, separate from devices that generate heat
- operating temperature: 5 ÷ 35 °C
- storage temperature: -20 ÷ 50 °C

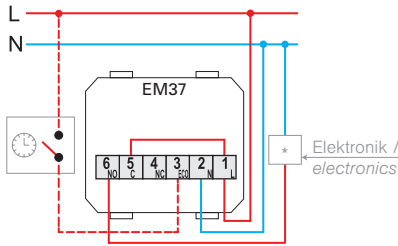

Umlaufpumpe, Brenner (Direktanschluss), thermoelektrischer Antrieb / circulation pump, burner (direct connection) thermoelectric drive

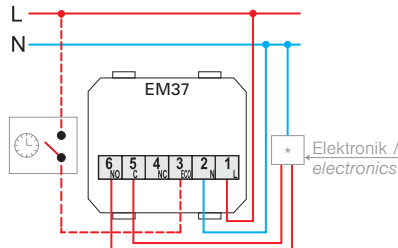

Kessel, Umlaufpumpe, Brenner (Steuereingang T1/T2)/ boiler, heat pump, burner (control input T1/T2)

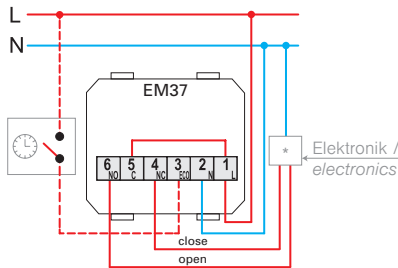

Motorantrieb (begrenzte Verwendung bei Fußbodenheizung)/ motor drive (limited use with underfloor heating)

Einstellung der Betriebsart und der Temperatur / function and temperature adjustment

Taste zur Betriebsartauswahl und LED-Zustandsanzeige:  
rot: Heizung  
blau: Kühlung  
leuchtet nicht: ausgeschaltet

function selection button and LED status indicator:  
red: heating  
blue: air conditioning  
no light: switched off

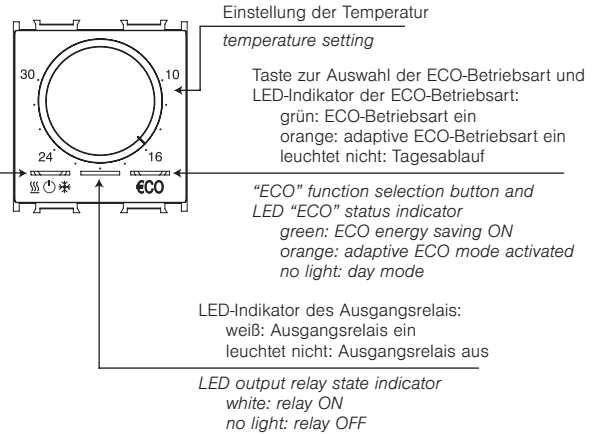

Hinweise/ attention

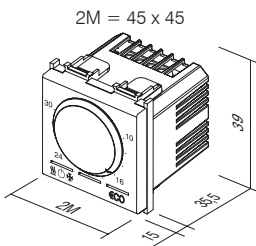
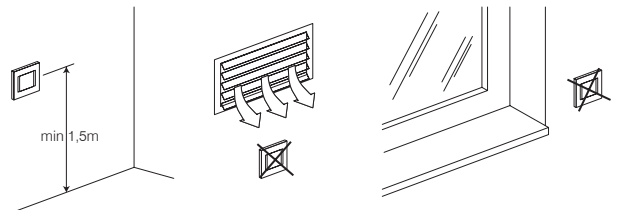

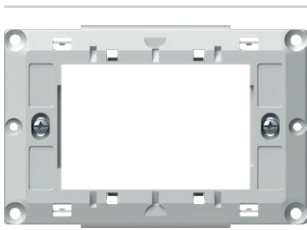

NM39

**MONTAGETRÄGER MIT SCHRAUBEN FÜR THERMOSTATE FANTINI COSMI 3M**

- Montageträger mit Schrauben für Thermostate Fantini Cosmi 3M
- bestimmt für die Verwendung mit Tages-Thermostaten Fantini Cosmi Modell CH121 und CH123
- bestimmt für die Verwendung mit Wochen-Thermostaten Fantini Cosmi Modell CH141A und CH143A
- Montage in Rechteckdosen 3M
- geeignet für Rahmen PURE, Line, Soft



**MOUNTING FRAME WITH SCREWS FOR FANTINI COSMI THERMOSTATS 3M**

- mounting frame with screws for Fantini Cosmi thermostats 3M
- suitable for use with Fantini Cosmi daily thermostats models CH121 and CH123
- suitable for use with Fantini Cosmi weekly thermostats models CH141A and CH143A
- for mounting in rectangular boxes 3M
- suitable for assembling with cover plates PURE, Line, Soft



- EM40PW
- EM40SB
- EM40AT
- EM40ES
- EM40IW

**ENERGIESPAR-KARTENSCHALTER 3A 250V~ 3M**

- elektronischer Schalter aktiviert durch beliebige Standard-ISO-Karte
- Versorgung 230 V~ 50 Hz
- Ausgangsrelais 3A 250V~ für einen externen Lastschalter\*
- Ausschaltungsverzögerung 15-20 s
- entspricht EN 61000-1
- ohne ISO-Karte, nicht zur Zutrittskontrolle bestimmt



**ENERGY SAVER CARD SWITCH 3A 250V~ 3M**

- card switch basic, any ISO card
- supply voltage 230V~ 50Hz
- output 3A 250V~ for switching contactor \*
- switch off delay 15-20s
- in accordance with EN 61000-6-1
- card is not included
- not for access control

3M = 67,5 x 45

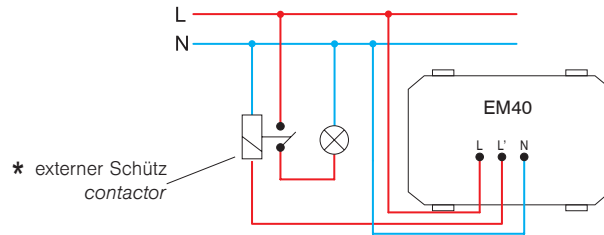
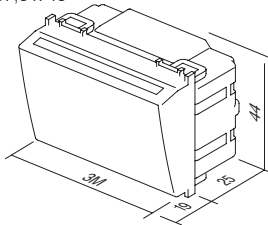

**KARTE ISO**

EM47

- KARTE ISO
- zur Verwendung mit Kartenschalter EM40
- Größe: 85x54 mm

**CARD ISO**

- ISO card
- for combination with card switch EM40
- size: 85x54 mm

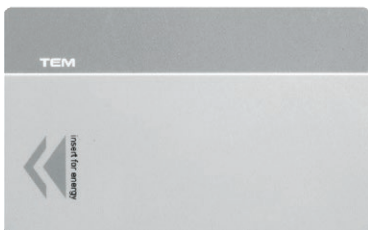

ENERGIESPAR-KARTENSCHALTER RF HF 13,56MHz 3M



EM44BK

- elektronischer Schalter aktiviert durch eine RFID-ISO-Karte
- Versorgung 5V von der Relaiseinheit EM49 über Kabel mit Anschlüssen RJ12
- Ausgang: Verbindung zur Relaiseinheit EM49
- Ausschaltverzögerung "main power" beim Ausziehen der Karte 15-20 s
- Ausschaltverzögerung "HVAC" beim Ausziehender Karte beim geöffneten Fenster oder Balkonür – 1 Minute
- entspricht EN 61000-1
- ohne ISO-Karte
- nicht zur Zutrittskontrolle bestimmt

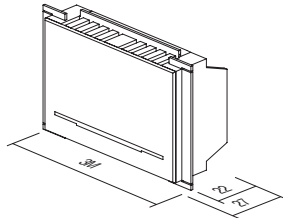

ENERGY SAVER CARD SWITCH RF HF 13,56MHz 3M

- electronic card switch for RFID ISO card
- supply from relay unit EM49 through cable connectors RJ12
- output to be connected to relay output unit EM49
- 15-20s "main power" switch off delay with card withdrawal
- 1 min "HVAC" switch off delay with card withdrawal when balcony doors or windows opened
- in accordance with EN 61000-6-1
- card is not included
- not for access control

RELAISEINHEIT FÜR KARTENSCHALTER 2X16A 250V~

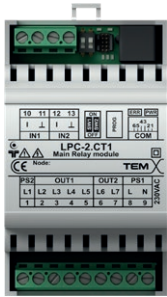

EM49

- Relaiseinheit für Kartenschalter EM44
- Versorgung 230 V~ 50 Hz
- entspricht EN 61000-1
- Montage auf eine DIN-Leiste 35mm, 3MU
- Ein- und Ausgänge im Bezug auf den Einbau: 1-zimmer oder 2-zimmer

ENERGY SAVER CONTROL UNIT 2x16A 250V~

- relay unit for card switches EM44
- supply voltage 230V~ 50Hz
- in accordance with EN 61000-6-1
- mounting on DIN rail 35mm, 3MU
- input and output depending on implementation: single or double room

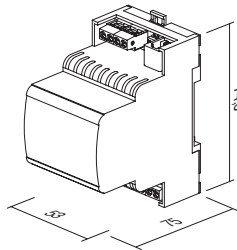

KABELEINFÜHRUNG SPL-1

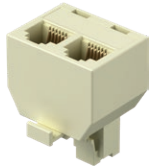

EM45

- zur Verbindung von zwei Kartenschalter EM44 mit Relaiseinheit EM49
- Kommunikationsanschluss RJ12
- Größe: 37 x 30 x 27 mm

SPLITTER SPL-1

- used to connect two peripheral modules EM44 to relay unit EM49
- communication connector RJ12
- size: 37 x 30 x 27 mm

Schaltschema für 1-zimmer-Betrieb / wiring diagram for single room implementation

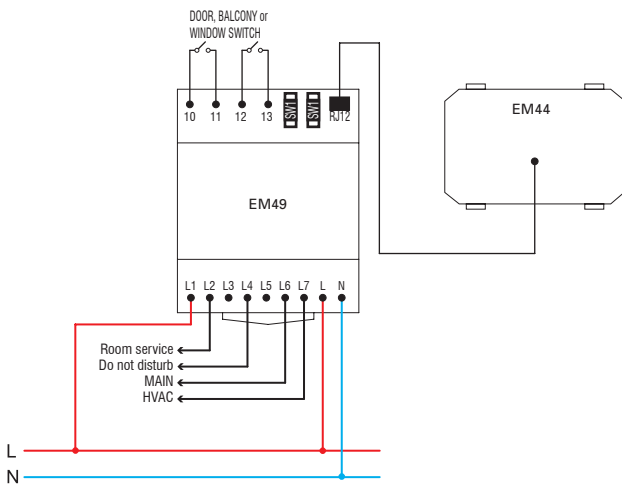

Schaltschema für 2-zimmer-Betrieb / wiring diagram for double room implementation

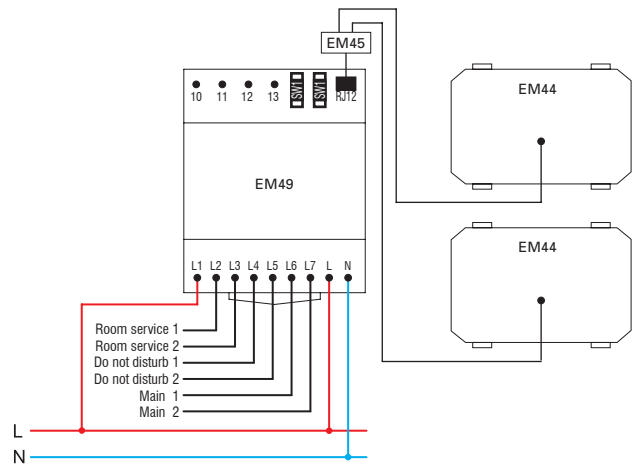

Verbindungskabel RJ12 zwischen EM44 und EM49 / connection cable RJ12 between EM44 and EM49

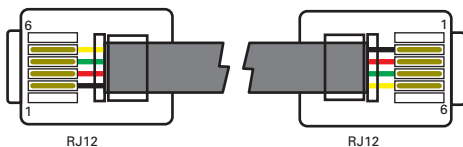

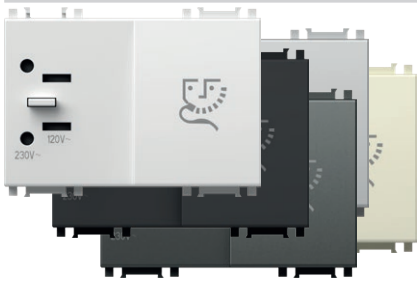

- EM60PW
- EM60SB
- EM60AT
- EM60ES
- EM60IW

**RASIERSTECKDOSE 230V~/120V~ 3M**

- Einsatz für Rasierer mit Transformator 20VA
- Eingang: 230V~ 50-60Hz
- Ausgang: 230V~ für 2P 2,5A-Eurostecker oder 120V~ für 2P 15A amerikanischen Stecker
- Schutzklasse II
- entspricht EN 61558-5

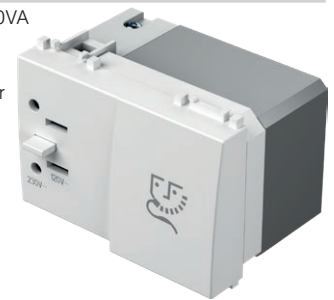

**SOCKET SHAVER 230V~/120V~ 3M**

- shaver supply unit with isolating transformer 20VA
- supply: 230V~ 50-60Hz
- output: 230V~ for 2P 2.5A Europlug or 120V~ for 2P 15A American plug
- Class II
- in accordance with EN 61558-2-5

3M = 67,5 x 45

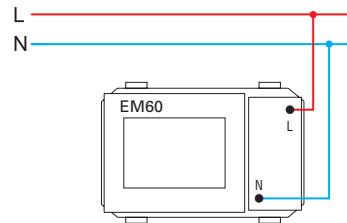
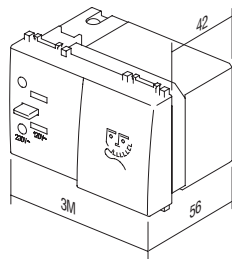

- EM66PW
- EM66SB
- EM66AT
- EM66ES
- EM66IW

**LADEGERÄT USB 5V 2,1A 1M**

- zum Laden der elektronischen Geräte über einen Standard-USB-Anschluss (kompatibel mit Apple-Geräten)
- Versorgung: 100-230 V~ 50/60 Hz
- Verbrauch im Betrieb: 300 mA bei 100 V~/150 mA bei 230 V~
- Verbrauch in Bereitstellung 30 mW bei 230 V~
- Ausgangsspannung 5 VAC (±5 %) SELV
- Schwankungen der Ausgangsspannung 150 mV
- nominaler Ausgangsstrom 2,1 A (1 x 2.100 mA) (±10 %)
- Nutzleistung: maximal 77 %
- Betriebstemperatur: 0 °C/+ 45 °C (Gebrauch im Innenbereich)
- Schutzart: IP20, nur für Gebrauch im Innenbereich geeignet
- Schutzklasse des Gerätes II
- Überspannungsschutz (EN 62109): Klasse III
- Schraubklemmen max. 2,5 mm<sup>2</sup>
- Gerät mit einem Kontaktabstand von min. 3 mm
- entspricht EN 60950-1 und der LVD- und EMC-Richtlinien

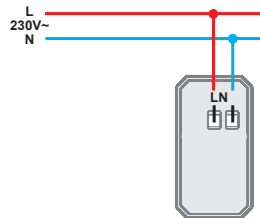
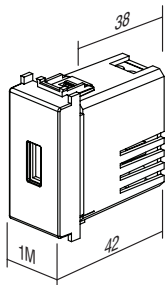

**USB POWER SUPPLY UNIT 5V 2,1A 1M**

- for charging of electronic devices via a standard USB port (also compatible with Apple devices)
- power supply: 100-230V~ 50/60Hz
- power consumption: 300mA at 100V~/150mA at 230V~
- standby power consumption: 30mW at 230V~
- nominal output voltage: 5 VDC (± 5%) SELV
- output ripple voltage: 150mV
- nominal output current: 2,1A (1 x 2.100mA) (±10%)
- efficiency: maximum of 77%
- operating temperature: 0°C/+45°C (indoor use)
- IP protection class: IP20, indoor use only
- class device II
- overvoltage category (EN 62109): Class III
- screw contacts: max. 2.5 mm<sup>2</sup>
- device with a contact gap of at least 3mm
- in accordance with EN 60950-1 and LVD & EMC directives

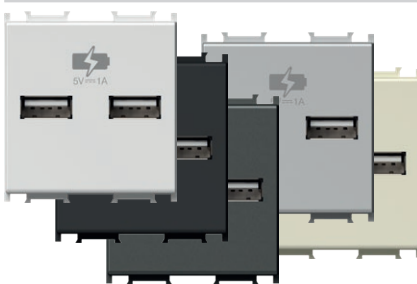

- EM65PW
- EM65SB
- EM65AT
- EM65ES
- EM65IW

**LADEGERÄT USB 5V 1A 2M**

- zum Laden der elektronischen Geräte über einen Standard-USB-Anschluss (kompatibel mit Apple-Geräten)
- zum gleichzeitigen Laden von zwei Geräten
- Versorgung: 230V~ 50Hz
- Verbrauch in Bereitstellung 50 mW bei 230V~
- Ausgangsspannung 5 VDC (+/5%) SELV
- Schwankungen der Ausgangsspannung 150 mV
- nominaler Ausgangsstrom 1 A (1 x 1000 mA oder 2 x 500 mA) (±10%)
- Nutzleistung: mehr als 67%
- Schutzart: IP20, nur für Gebrauch im Innenbereich geeignet
- Schraubklemmen max. 2,5 mm<sup>2</sup>
- entspricht EN 60950-1 und der EMC-Richtlinie
- das Ladegerät muss mit einem geeigneten externen Schutzschalter geschützt werden

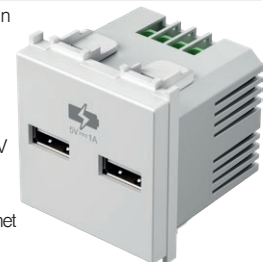

2M = 45 x 45

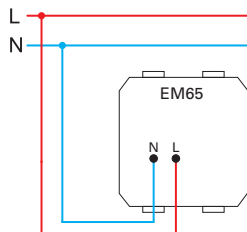
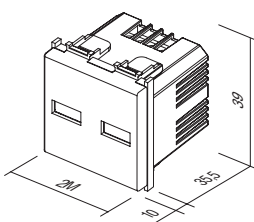

**POWER SUPPLY UNIT USB 5V 1A 2M**

- for charging of electronic devices via a standard USB port (also compatible with Apple devices)
- enables charging of two devices simultaneously
- power supply: 230V~ 50Hz
- stand-by power consumption: 50 mW at 230V~
- nominal output voltage: 5 VDC (±5%) SELV
- output ripple voltage: 150 mV
- nominal output current: 1 A (1 x 1.000 mA or 2 x 500 mA) (±10%)
- efficiency: greater than 67%
- IP protection class: IP20, indoor use only
- screw contacts: max. 2.5 mm<sup>2</sup>
- in accordance with EN 60950-1 and EMC directive
- an appropriate external disconnect device needs to be considered as part of installation



- EM67PW
- EM67SB
- EM67AT
- EM67ES
- EM67IW

**LADEGERÄT USB 5V 2,4A 1M**

- zum Laden der elektronischen Geräte über einen Standard-USB-Anschluss (kompatibel mit Apple-Geräten)
- Versorgung: 100–230 V<sup>~</sup> 50/60 Hz
- Verbrauch im Betrieb: 300 mA bei 100 V<sup>~</sup> / 150 mA bei 230 V<sup>~</sup>
- Verbrauch in Bereitstellung 30 mW bei 230 V<sup>~</sup>
- Ausgangsspannung 5 VAC (±5 %) SELV
- Schwankungen der Ausgangsspannung 150 mV
- nominaler Ausgangsstrom 2,4 A (±10 %)
- Nutzleistung: maximal 77 %
- Betriebstemperatur: 0 °C/+ 45 °C (Gebrauch im Innenbereich)
- Schutzart: IP20, nur für Gebrauch im Innenbereich geeignet
- Schutzklasse des Gerätes II
- Überspannungsschutz (EN 62109): Klasse III
- Schraubklemmen max. 2,5 mm<sup>2</sup>
- Gerät mit einem Kontaktabstand von min. 3 mm
- entspricht EN 60950-1 und der LVD- und EMC-Richtlinien

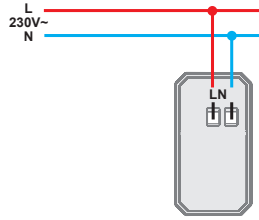
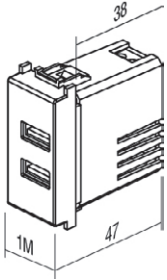

**USB POWER SUPPLY UNIT 5V 2,4A 1M**

- for charging of electronic devices via a standard USB port (also compatible with Apple devices)
- power supply: 100-230V<sup>~</sup> 50/60Hz
- power consumption: 300mA at 100V<sup>~</sup> / 150mA at 230V<sup>~</sup>
- standby power consumption: 30mW at 230V<sup>~</sup>
- nominal output voltage: 5 VCD (± 5%) SELV
- output ripple voltage: 150mV
- nominal output current: 2,4A (±10%)
- efficiency: maximum of 77%
- operating temperature: 0°C/+45°C (indoor use)
- IP protection class: IP20, indoor use only
- class device II
- overvoltage category (EN 62109): Class III
- screw contacts: max. 2.5 mm<sup>2</sup>
- device with a contact gap of at least 3mm
- in accordance with EN 60950-1 and LVD & EMC directives

**LED-NOTLEUCHTE 250V~ 0,9W, NiCd 3h 7M**



- EM55

- LED-Notleuchte
- Versorgung 250V<sup>~</sup> 50Hz 3x LED 0,3W 10000mcd, 6500K
- NiCd-Akku 400 mAh, auswechselbar
- 3h-Autonomie, Ladezeit 24 h
- Schutzklasse II
- entspricht EN 60598-1, EN 60598-2-2, EN 60598-2-22



**LED EMERGENCY LIGHT 250V~ 0.90W, NiCd 3h 7M**

- emergency LED lamp
- supply voltage 250V<sup>~</sup> 50Hz 3x LED 0,3W, 10000mcd, 6500K
- NiCd accumulator 400 mAh, replaceable
- autonomy 3h, charging 24h
- Class II
- in accordance with EN 60598-1, EN 60598-2-2, EN 60598-2-22

7M = 151,5 x 45

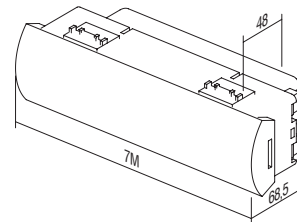
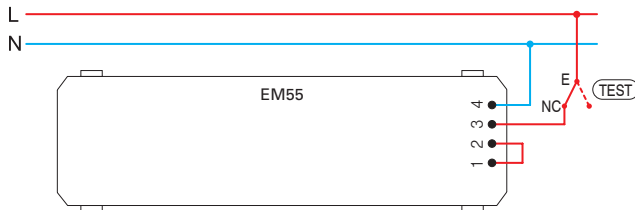

**LED-NOTLEUCHTE 230V~50Hz, 0.5W, NiMH 2h 2M**



- EM57

- LED-Notleuchte
- kann als tragbare Handlampe verwendet werden (ausziehbarer Mechanismus)
- Versorgung 230V<sup>~</sup> 50Hz, 1xLED 0.5W
- NiMH-Akku 140mAh, auswechselbar
- 2h-Autonomie, Ladezeit 36h
- Schutzklasse II
- entspricht EN60598-1, EN60598-2-2, EN62471, EN55015:2006, EN61547

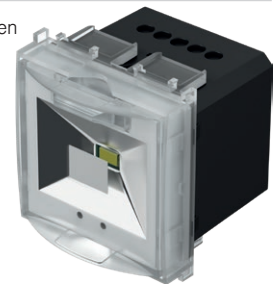

**LED EMERGENCY LIGHT 230V~50Hz, 0.5W, NiMH 2h 2M**

- emergency LED lamp
- option to use it as a hand lamp (pull-out mechanism)
- supply voltage 230V<sup>~</sup> 50Hz, 1xLED 0.5W
- NiMH accumulator 140mAh, replaceable
- autonomy 2h, charging 36h
- class device II
- in accordance EN60598-1, EN60598-2-2, EN62471, EN55015:2006, EN61547

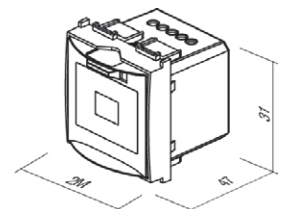
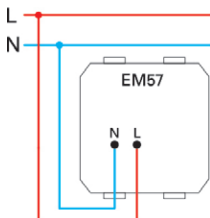



**LED-LAMPE EINFARBIG 250V~ 0,8W 2M**

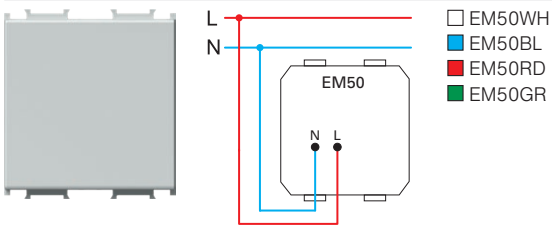

- LED-Lampe für Beleuchtung von Treppen und Gängen
- Versorgung 230V~ 50Hz 0,8W, 6500K
- Schutzklasse II
- entspricht EN 60598-1
- auch als Lenk- bzw. Signallampe verwendbar, Laserdruck-Möglichkeit von beliebigen Symbolen

**LED LAMP MONOCOLOR 250V~ 0,8W 2M**

- step marker LED lamp
- supply voltage 230V~ 50Hz 0,8W, 6500K
- Class II
- in accordance with EN 60598-1
- optional usage for directional or signal illumination with customized laser printing on diffuser



**LED-LAMPE ZWEIFARBIG 250V~ 2x0,4W 2M**

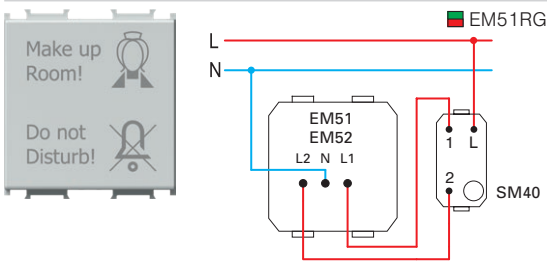

- 2-farbige LED-Signallampe
- Versorgung 230V~ 50Hz 2x0,4W, 6500K
- Schutzklasse II
- entspricht EN 60598-1
- mit Symbol, wie auf dem Bild dargestellt
- Laserdruck-Möglichkeit von beliebigen Symbolen

**LED LAMP DUAL COLOR 250V~ 2x0,4W 2M**

- signaling dual color (red/green) LED lamp
- supply voltage 230V~ 50Hz 2x0,4W, 6500K
- Class II
- in accordance with EN 60598-1
- diffuser includes graphics as shown
- possible customized laser printing on diffuser



**LED-LAMPE 3D ZWEIFARBIG 250V~ 2x0,4W 2M**

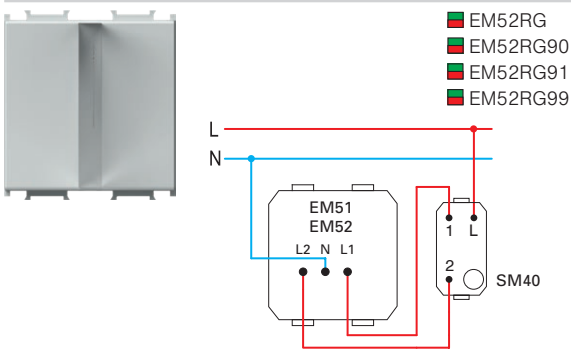

- 2-farbige LED-Signallampe (rot/grün) mit 3D-Symbol
- Versorgung 230V~ 50Hz 2x0,4 W, 6500K
- Schutzklasse II
- entspricht EN 60598-1
- Druckmöglichkeit von verschiedenen Symbolen nach Bestellung
- 90 Männersymbol, 91 Frauensymbol, 99 Symbol nach Bestellung

**LED LAMP 3D DUAL COLOR 250V~ 2x0,4W 2M**

- signalling LED lamp, dual color (red/green) with 3D symbol
- supply voltage 230V~ 50Hz 2x0,4W, 6500K
- class II
- in accordance with EN 60598-1
- possible customized graphics on request
- 90 male symbol, 91 female symbol, 99 symbol on request

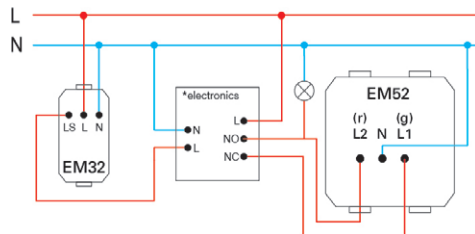
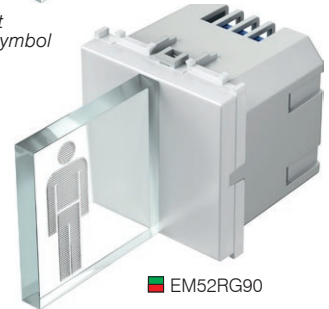
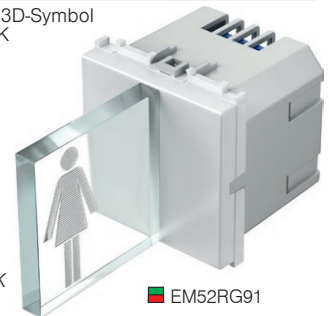

2M = 45 x 45

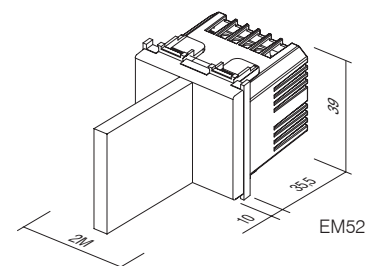
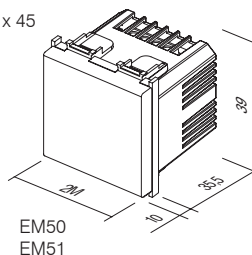

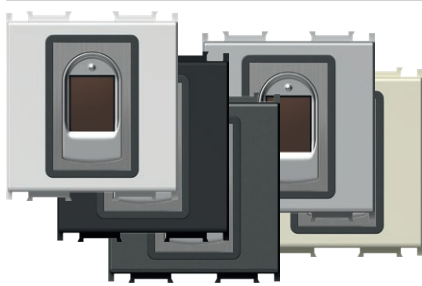

- EM71PW
- EM71SB
- EM71AT
- EM71ES
- EM71IW

FINGERABDRUCKLESER BIOPASS 2M

- Fingerabdruckschalter komplett mit Innen-Relaiseinheit und Netzteil
- Kapazität: 500 Fingerabdrücke
- einfache Bedienung über die mobile Anwendung X-Manager
- Versorgung: 8-30 V – DC oder AC (inkl. Netzteil)
- kapazitiver Sensor
- 2 Ausgangsrelais
- maximale Spannung/Strom am Relais: 40V/3A
- Auslösezeit des Relais: 1 - 10 s
- maximale Leistung 3,6 W
- 256-Bit-Verschlüsselung der Verbindung zwischen Schalter und der Innen-Relaiseinheit
- Das Set enthält auch den Träger NM24 und den dekorativen Rahmen OS20.

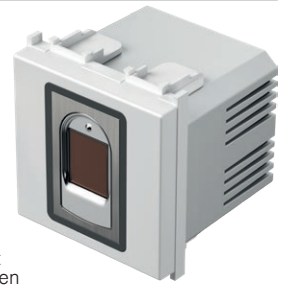

FINGERPRINT SWITCH BIOPASS 2M

- fingerprint switch with included internal relay unit and power supply
- capacity: 500 fingerprints
- easy management via X-Manager mobile app
- power supply voltage: 8-30V – DC or AC (power supply included)
- capacitive sensor
- 2 output relays
- maximum voltage/current on relay: 40V/3A
- relay triggering time: 1-10 sec
- maximum power: 3.6W
- 256-bit encrypted link between switch and internal relay unit
- Set also includes NM24 mounting frame and OS20 decorative cover plate.

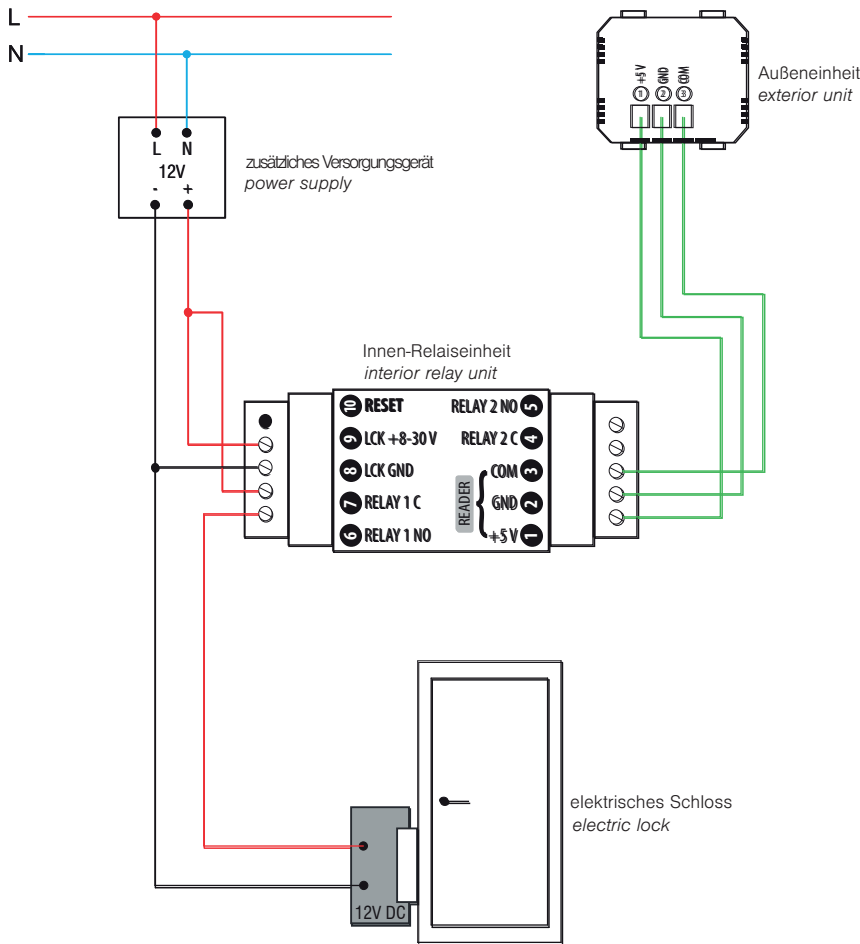

X-Manager app

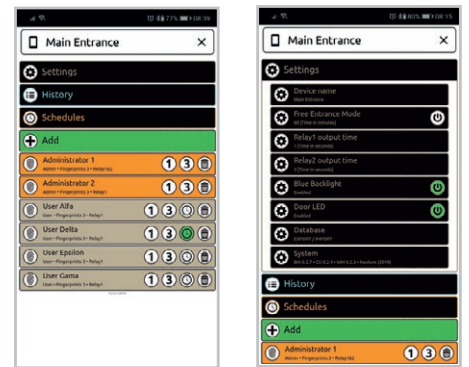

support.tem.si



Außeneinheit  
exterior unit

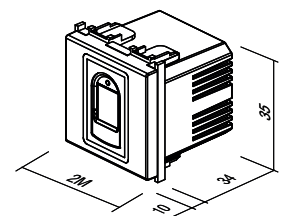

SCHALTER BERÜHRUNGSLOS 10A 240V~



EM80GW

- Ein-/Ausschalter berührungslos ("master")
- Versorgung: 240 V~ 50 Hz
- Ausgangsrelais 10A / 250V~ (2400W bei 240V~)
- Reichweite einstellbar von 2 bis 10 cm
- für die Montage in eine Standardmäßige Runddose mit einem Durchmesser von Ø60 mm
- zum Anschluss wird unbedingt ein Neutralleiter (N) benötigt kann nicht mit Wechselschalter verbunden werden
- Schaltung von bis zu 5 zusätzlichen Kontrollschalter EM81 möglich
- einfache Montage der Dekorrahmen mit Hilfe von Magneten
- Schraubklemmen 2,5 mm<sup>2</sup> (max. Kraft zum Festziehen der Schrauben 0,4 Nm)
- entspricht EN 60669-1 und EN 60669-2-1
- nur für Gebrauch im Innenbereich



SWITCH, TOUCHLESS 10A 240V~

- touchless switch for turning on/off ("master")
- power supply: 240 V~ 50 Hz
- output relay 10A / 250V~ (2400W at 240V~)
- adjustable range from 2 to 10 cm
- intended for installation into a standard round Ø60 mm box
- a neutral lead (N) is required for connection
- connection with toggle switches is not possible
- connection with up to 5 EM81 control switches is possible
- simple installation of decorative covers with the help of magnets
- screw fastening of leads up to 2.5 mm<sup>2</sup> (max. screw tightening torque is 0.4 Nm)
- in accordance with EN 60669-1 and EN 60669-2-1
- only for indoor use

KONTROLLSCHALTER BERÜHRUNGSLOS



EM81GW

- Kontrollschalter („Slave“)
- nur in Kombination mit Schalter EM80 („Master“)
- Reichweite einstellbar von 2 bis 10 cm
- einfache Montage der Dekorrahmen mit Hilfe von Magneten
- Schraubklemmen 2,5 mm<sup>2</sup> (max. Kraft zum Festziehen der Schrauben 0,4 Nm)
- entspricht EN 60669-1 und EN 60669-2-1
- nur für Gebrauch im Innenbereich

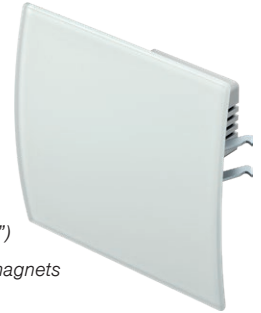

SWITCH, TOUCHLESS, CONTROL UNIT

- control switch ("slave")
- works only when connected with the EM80 switch ("master")
- adjustable range from 2 to 10 cm
- simple installation of decorative covers with the help of magnets
- screw fastening of leads up to 2.5 mm<sup>2</sup> (max. screw tightening torque is 0.4 Nm)
- in accordance with EN 60669-1 and EN 60669-2-1
- only for indoor use

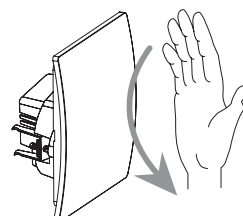
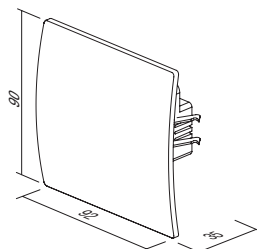
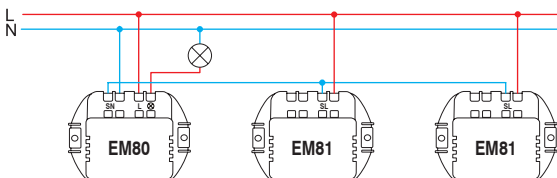
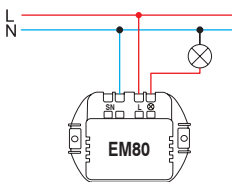

SUMMER 8VA 230V~ 1M

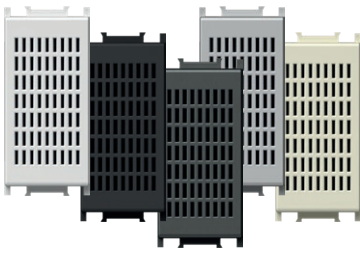

- EM90PW
- EM90SB
- EM90AT
- EM90ES
- EM90IW

- Signalsummer  
 - der Klingelton dauert an, solange Sie auf die Taste drücken  
 - Versorgung 230V~ 50Hz 8VA

*BUZZER 8VA 230V~1M*

- signal buzzer  
 - the sound emission has the same lasting time as the control operation  
 - supply voltage 230V~ 50Hz 8VA



SUMMER 8VA 12V~ 1M

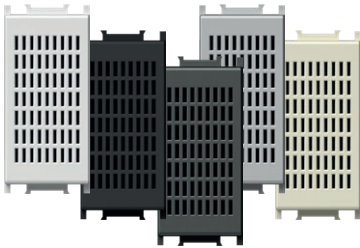

- EM91PW
- EM91SB
- EM91AT
- EM91ES
- EM91IW

- Signalsummer  
 - der Klingelton dauert an, solange Sie auf die Taste drücken  
 - Versorgung 12V~ 50Hz 8VA

*BUZZER 8VA 12V~1M*

- signal buzzer  
 - the sound emission has the same lasting time as the control operation  
 - supply voltage 12V~ 50Hz 8VA



KLINGEL 8VA 230V~ 1M

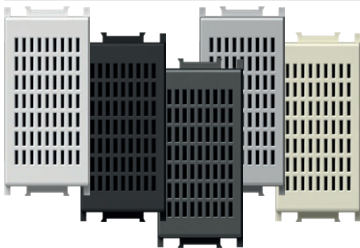

- EM92PW
- EM92SB
- EM92AT
- EM92ES
- EM92IW

- Signalklingel  
 - der Klingelton dauert an, solange Sie auf die Taste drücken  
 - Versorgung 230V~ 50Hz 8VA

*BELL 8VA 230V~1M*

- signal bell  
 - the sound emission has the same lasting time as the control operation  
 - supply voltage 230V~ 50Hz 8VA



KLINGEL 8VA 12V~ 1M

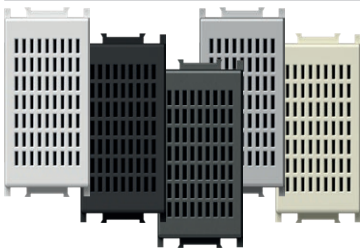

- EM93PW
- EM93SB
- EM93AT
- EM93ES
- EM93IW

- Signalklingel  
 - der Klingelton dauert an, solange Sie auf die Taste drücken  
 - Versorgung 12V~ 50Hz 8VA

*BELL 8VA 12V~1M*

- signal bell  
 - the sound emission has the same lasting time as the control operation  
 - supply voltage 12V~ 50Hz 8VA

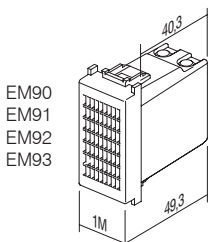

EM90  
 EM91  
 EM92  
 EM93

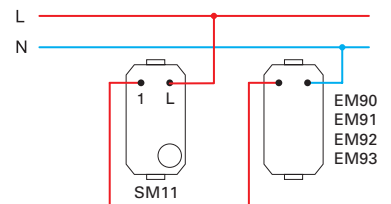

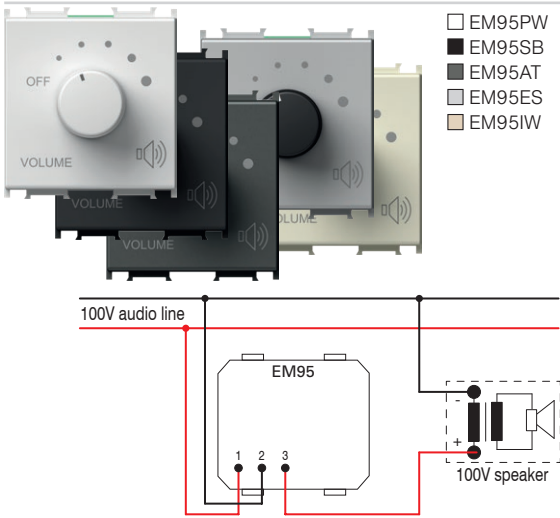

**LAUTSTÄRKENREGLER FÜR 100 V AUDIOLINIE 35W 2M**

- Lautstärkenregler (Attenuator) für 100 V Audiosysteme
- Nennleistung 35 W (max. 45 W), 6-stufige Lautstärkenregelung
- geeignet für den Einbau in tiefe Dosen (min. 60 mm)
- nicht geeignet für den Einbau in Dosen mit Tiefe 45 mm und Gehäuse CUBO IP20
- nur für Gebrauch im Innenbereich

**VOLUME CONTROL 100V AUDIO LINE 35W 2M**

- volume control (attenuator) for 100V audio systems
- power rating 35W (max.45W), 6 steps volume control
- suitable for boxes min. 60 mm deep
- not suitable for installation in 45 mm deep boxes and surface mount boxes CUBO IP20
- for indoor use only

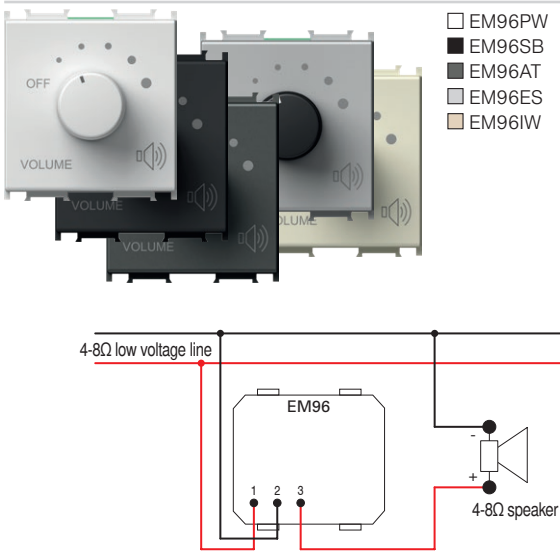
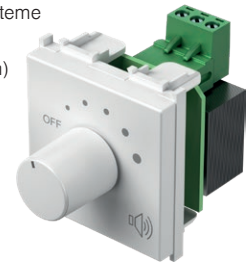

**NIEDEROHMIGER LAUTSTÄRKENREGLER 4-8 Ω 35W 2M**

- Lautstärkenregler für niederohmige Ausgänge 4-8 Ω 35W
- zum Anschluss an Hi-Fi-Geräte
- Nennleistung 35 W, 6-stufige Lautstärkenregelung
- geeignet für den Einbau in tiefe Dosen (min. 60 mm)
- nicht geeignet für den Einbau in Dosen mit Tiefe 45 mm und Gehäuse CUBO IP20
- nur für Gebrauch im Innenbereich

**VOLUME CONTROL 4-8 Ω 35W 2M**

- volume control (attenuator) for low voltage outputs 4-8 Ω, 35W
- power rating 35W, 6 steps volume control
- suitable for boxes min. 60 mm deep
- not suitable for installation in 45 mm deep boxes and surface mount boxes CUBO IP20
- for indoor use only

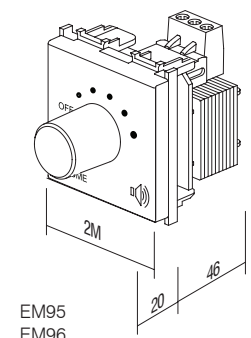
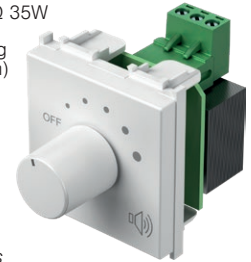

EM95  
EM96



CM25

PW

OS

Typ type	Bezeichnung description	Technische Daten technical data	Größe size	Farbe colour	Optionsbezeichnung 1 optional data 1
CM10	SET STECKDOSEN 2x SCHUKO SOCKET SET 2x SCHUKO	2P+E 16A 250V~	4M	<input type="checkbox"/> PW weiß-glänzend polar white	<input type="checkbox"/> OL Rahmen LINE cover plate LINE
CM11	SET STECKDOSEN 3x SCHUKO SOCKET SET 3x SCHUKO	2P+E 16A 250V~	7M	<input checked="" type="checkbox"/> SB schwarz-matt soft touch black	<input type="checkbox"/> OS Rahmen SOFT cover plate SOFT
CM15	SET VERDRÄHTUNGSBRÜCKEN FARBIG LINK WIRE SET	3x1.5mm <sup>2</sup>	1M	<input checked="" type="checkbox"/> AT anthrazit anthracite	
⋮	⋮	⋮	⋮	<input type="checkbox"/> ES silber-matt elox silver	
⋮	⋮	⋮	⋮	<input type="checkbox"/> IW beige-glanz ivory white	

SET STECKDOSEN 2x SCHUKO 2P+E 16A 250V~ 4M

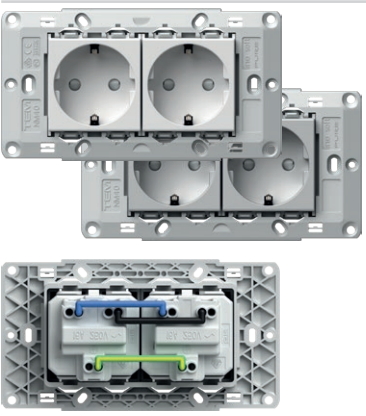

- CM10PW
- CM10ES

- Steckdosen-Set 2x Schuko VM10 2P+E 16A 250V~
- Steckdosen verbunden durch Verdrahtungsbrücken CM16
- mit Träger 4M ohne Schrauben
- zur Befestigung verwenden Sie Schrauben CM17, CM18 oder CM19
- Schraubklemmen 1,5-2,5 mm<sup>2</sup>
- entspricht IEC 60884-1, CEE7

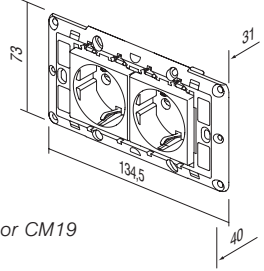

SOCKETS SET 2x SCHUKO 2P+E 16A 250V~ 4M

- socket set 2x schuko VM10 2P+E 16A 250V~
- prewired with link wires CM16
- with mounting frame 4M without screws
- for mounting frame fixing use screws CM17, CM18 or CM19
- screw contacts 1.5-2.5 mm<sup>2</sup>
- in accordance with IEC-60884-1, CEE7

SET STECKDOSEN 3x SCHUKO 2P+E 16A 250V~ 7M

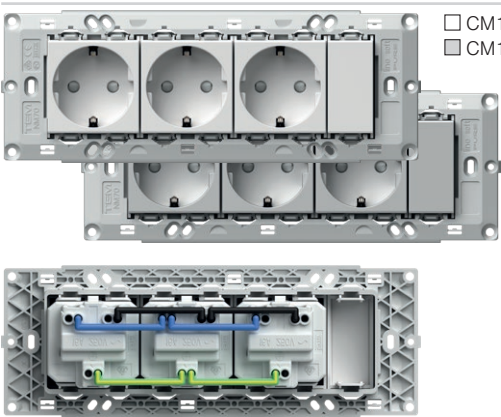

- CM11PW
- CM11ES

- Steckdosen-Set 3x Schuko VM10 2P+E 16A 250V~
- Steckdosen verbunden durch Verdrahtungsbrücken CM16
- mit Träger 7M ohne Schrauben
- zur Befestigung verwenden Sie Schrauben CM17, CM18 oder CM19
- Schraubklemmen 1,5-2,5 mm<sup>2</sup>
- entspricht IEC 60884-1, CEE7

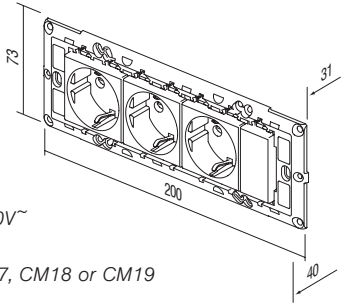

SOCKETS SET 3x SCHUKO 2P+E 16A 250V~ 7M

- socket set 3x schuko VM10 2P+E 16A 250V~
- prewired with link wires CM16
- with mounting frame 7M without screws
- for mounting frame fixing use screws CM17, CM18 or CM19
- screw contacts 1.5-2.5 mm<sup>2</sup>
- in accordance with IEC-60884-1, CEE7



CM15

**SET VERDRÄHTUNGSBRÜCKEN FARBIG 3x1,5 mm<sup>2</sup> 1M**

- Verdrahtungsbrücken-Set für Verbindung zweier Elemente mit Breite 1M
- Inkl. 10 schwarze, 10 blaue und 10 gelb-grüne Verdrahtungsbrücken

**LINK WIRE SET 3x1.5mm<sup>2</sup> 1M**

- link wire set to connect two elements size 1M
- includes 10 black, 10 blue and 10 yellow/green wires

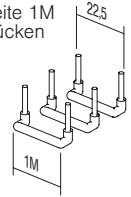

CM16

**SET VERDRÄHTUNGSBRÜCKEN FARBIG 3x2,5 mm<sup>2</sup> 2M**

- Verdrahtungsbrücken-Set für Verbindung zweier Elemente mit Breite 2M
- Inkl. 10 schwarze, 10 blaue und 10 gelb-grüne Verdrahtungsbrücken

**LINK WIRE SET 3x2.5mm<sup>2</sup> 2M**

- link wire set to connect two elements size 2M
- includes 10 black, 10 blue and 10 yellow/green wires

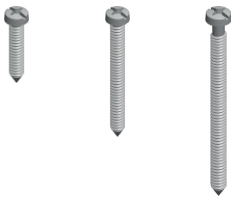
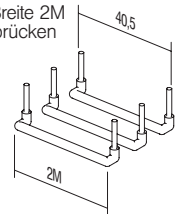

CM17  
CM18  
CM19

**SCHRAUBEN-SET 3,5**

- Set mit Befestigungsschrauben für Montageträger NM30, NM32, NM40, NM41, NM70
- CM17 - l=20mm, 100 Stück
- CM18 - l=35mm, 50 Stück
- CM19 - l=50mm, 50 Stück

**SCREW SET 3,5**

- screw set for fixing mounting frames NM30, NM32, NM40, NM41, NM70
- CM17 - l=20mm, 100pcs
- CM18 - l=35mm, 50pcs
- CM19 - l=50mm, 50pcs

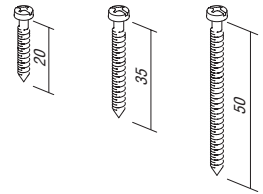

CM22PW

**SCHALTER-SET IP44 2M**

- geeignet für feuchte Räume
- Schutzart IP44 nur in Kombination mit Schalter Modul
- Schalter und Wippen sind nicht im Set enthalten
- Rahmen SOFT 2M mit Namensschild
- entspricht IEC 60669-1

**SET SWITCHES IP44 2M**

- for usage in humid areas
- IP44 protection provides for all Modul switches
- switches and buttons are not part of the set
- SOFT 2M cover plate with inscription plate
- in accordance with IEC 60669-1



CM23PW

**STECKDOSE-SET IP44 2M**

- geeignet für feuchte Räume
- Schutzart IP44 nur in Kombination mit Steckdose mit Klappdeckel (VM11, VM41)
- Steckdosen sind nicht im Set enthalten
- Rahmen SOFT 2M mit Namensschild
- entspricht IEC 60884-1

**SET SOCKETS IP44 2M**

- for usage in humid areas
- IP44 protection can be achieved only in combination with covered socket (VM11, VM41)
- sockets are not part of the set
- SOFT 2M cover plate with inscription plate
- in accordance with IEC 60884-1

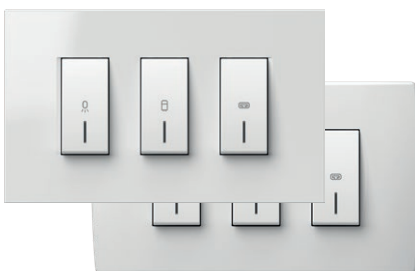

CM25PWOL  
 CM25IWOL  
  
 CM25PWOS  
 CM25IWOS

**BADEZIMMER-SET 3x20A 250V~ 4M**

- Schalter-Set 3xSM12 20A 250V~ mit Montageträger und Rahmen
- Schraubklemmen 1,5-2,5mm<sup>2</sup>
- entspricht EN 60669-1
- Befestigungsmöglichkeit in bereits eingebaute Dosen mit Befestigungsmaßen von 108 bis 135 mm oder in Dosen in Größe 4M
- Höhe des Rahmens 90mm

**SWITCH SET FOR BATHROOM 3x20A 250V~ 4M**

- switch set 3xSM12 20A 250V~ with mounting frame and cover plate
- screw contacts 1.5-2.5mm<sup>2</sup>
- in accordance with EN 60669-1
- universal solution for renovation on boxes with fixing dimensions 108-135mm or boxes 4M size
- cover plate height 90mm

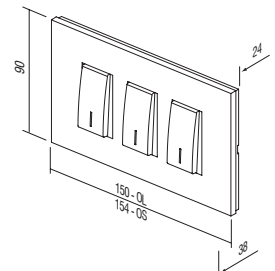



NM41





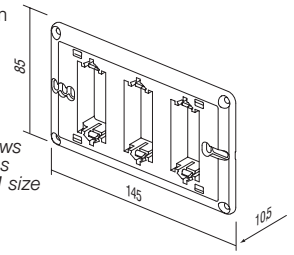

**MONTAGETRÄGER FÜR BADEZIMMER-SET 4M**

- UniversalMontageträger für Badezimmer-Set mit Schrauben
- Befestigungsmöglichkeit in bereits eingebaute Dosen mit Befestigungsmaßen von 108 bis 135 mm oder in Dosen in Größe 4M
- entspricht EN 60669-1

**MOUNTING FRAME BATHROOM SET 4M**

- universal mounting frame for bathroom set with screws
- universal solution for mounting on rectangular boxes with fixing dimensions 108-135mm or boxes 4M size
- in accordance with EN 60669-1



-  OL41PW
-  OL41NB
-  OL41IW
-  OL41ES
-  OL41SG
-  OL41IB

**RAHMEN LINE FÜR BADEZIMMER-SET**

- dekorativer Rahmen LINE für Badezimmer-Set
- Höhe 90mm
- entspricht EN 60669-1

**COVER PLATE LINE BATHROOM SET**

- decorative cover plate bathroom set LINE
- height 90mm
- in accordance with EN 60669-1

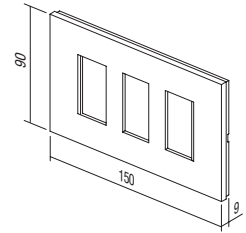

-  OS41PW
-  OS41NB
-  OS41IW
-  OS41ES
-  OS41SG
-  OS41SB
-  OS41WE

**RAHMEN SOFT FÜR BADEZIMMER-SET**

- dekorativer Rahmen SOFT für Badezimmer-Set
- Höhe 90mm
- entspricht EN 60669-1

**COVER PLATE SOFT BATHROOM SET**

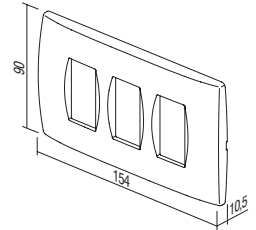

- decorative cover plate bathroom set SOFT
- height 90mm
- in accordance with EN 60669-1









Typ type	Bezeichnung description	Größe size	Farbe colour	Optionsbezeichnung 1 optional data 1
TM11	WIPPE BUTTON	1M	<input type="checkbox"/> AW antibakterien weiß antibacterial white	 NT neutral neutral
TM21	BLLENDE BLANK	1M		
VM10	STECKDOSE SOCKET	2M		 IN Indikator indicator
.	.	.		
.	.	.		













**ANTIBAKTERIENPROGRAMM MODUL**

- Schalter und Steckdosen werden tagtäglich den Kontakt von zahlreichen Menschen ausgesetzt und sind aufgrund dessen häufig Stellen zur Entwicklung und Verbreitung von Bakterien.
- Dank seiner antibakteriellen Eigenschaften ist Silber bereits seit 3 Jahrtausenden ein sicheres und effizientes Desinfektionsmittel, denn es ist vollkommen natürlich und Gesundheit- und umweltfreundlich.
- Ein besonderer antibakterieller Zusatz von Silberionen gewährleistet einen langfristigen, zuverlässigen und effizienten Schutz gegen die Entwicklung und Verbreitung von verschiedenen Bakterien, Viren, Mikroben und Pilzen.
- Antibakterienschutz bedeutet höhere Hygiene, Reinheit und Gesundheit für Menschen.
- Das Antibakterienprogramm Modul eignet sich zur Verwendung überall dort, wo strenge Hygienebedingungen herrschen (Krankenhäuser, Gesundheitszentren, pharmazeutische Einrichtungen, Pflegeheime, Laboratorien, Restaurants, Hotels, Flughafen, Bus- und Bahnstationen, Geschäfts- und Einkaufszentren, öffentliche Einrichtungen usw.).
- Die Labortests wurden in einer unabhängigen Institution nach höchsten japanischen Normen durchgeführt.
- Das Antibakterienprogramm Modul ermöglicht niedrige Kosten zur Gesundheitserhaltung.
- Die Form und Funktionalität des Antibakterienprogramms Modul ermöglichen einfache Reinigung und Wartung.
- Das Antibakterienprogramm Modul wird mit antibakteriellen Wippen, Rahmen und Steckdosen zusammen mit klassischen Montageträgern und Schaltern kombiniert.
- Jedes Produkt ist aufgrund der einfacheren Identifikation an der Rückseite durch AW (antibacterial white) gekennzeichnet.

**ANTIBACTERIAL PROGRAM MODUL**

- switches and sockets are daily touched by many people, so this is a common place for development and spread of bacteria
- thanks to its natural antibacterial characteristics silver has been used for three millennia as a safe and effective disinfectant, since it is completely natural, healthy and environmentally friendly
- special antibacterial silver ions additive provides long-term, reliable and effective protection against the development and spread of bacteria, viruses, microbes and fungi
- antibacterial protection ensures hygiene, cleanliness and health for people
- perfectly suitable for use in environments with strict hygiene conditions (hospitals, health centers, pharmaceutical facilities, homes for elderly, nursing homes, laboratories, restaurants, hotels, airports, bus and railway stations, business and shopping areas, public institutions ...)
- independent laboratory testings have been carried out in accordance with highest Japanese standards JIS Z 2801
- low cost for providing human health
- design and functionality of antibacterial program MODUL allow easy cleaning and maintenance
- antibacterial buttons, cover plates and sockets are combined with classic mounting frames and switches
- products are labelled on the back with AW (antibacterial white)

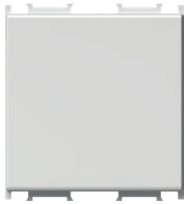
## A N T I B A C T E R I A L P R O G R A M M M O D U L

	<input type="checkbox"/> TM11AW	<p><b>WIPPE 1M</b></p> <ul style="list-style-type: none"> <li>- Wippe auswechselbar, Breite 1M</li> <li>- entspricht EN 60669-1</li> <li>- Antibakterienschutz gemäß JIS Z 2801</li> </ul> <p><b>BUTTON 1M</b></p> <ul style="list-style-type: none"> <li>- replaceable button 1M</li> <li>- in accordance with EN 60669-1</li> <li>- antibacterial protection in accordance with JIS Z 2801</li> </ul>	
	<input type="checkbox"/> TM11AWIN	<p><b>WIPPE MIT INDIKATOR 1M</b></p> <ul style="list-style-type: none"> <li>- Wippe auswechselbar, Breite 1M</li> <li>- entspricht EN 60669-1</li> <li>- Antibakterienschutz gemäß JIS Z 2801</li> </ul> <p><b>BUTTON 1M INDICATOR</b></p> <ul style="list-style-type: none"> <li>- replaceable button 1M</li> <li>- in accordance with EN 60669-1</li> <li>- antibacterial protection in accordance with JIS Z 2801</li> </ul>	
	<input type="checkbox"/> TM12AW	<p><b>WIPPE 2M</b></p> <ul style="list-style-type: none"> <li>- Wippe auswechselbar, Breite 2M mit Wippenträger</li> <li>- zur Erweiterung von Schaltern oder Tastern in Breite 1M auf Breite 2M</li> <li>- entspricht EN 60669-1</li> <li>- Antibakterienschutz gemäß JIS Z 2801</li> </ul> <p><b>BUTTON 2M</b></p> <ul style="list-style-type: none"> <li>- replaceable button 2M with button carrier</li> <li>- to upgrade switch or push button from size 1M to size 2M</li> <li>- in accordance with EN 60669-1</li> <li>- antibacterial protection in accordance with JIS Z 2801</li> </ul>	
	<input type="checkbox"/> TM12AWIN	<p><b>WIPPE MIT INDIKATOR 2M</b></p> <ul style="list-style-type: none"> <li>- Wippe auswechselbar, Breite 2M mit Wippenträger</li> <li>- zur Erweiterung von Schaltern oder Tastern in Breite 1M auf Breite 2M</li> <li>- entspricht EN 60669-1</li> <li>- Antibakterienschutz gemäß JIS Z 2801</li> </ul> <p><b>BUTTON 2M INDICATOR</b></p> <ul style="list-style-type: none"> <li>- replaceable button 2M with button carrier</li> <li>- to upgrade switch or push button from size 1M to size 2M</li> <li>- in accordance with EN 60669-1</li> <li>- antibacterial protection in accordance with JIS Z 2801</li> </ul>	
	<input type="checkbox"/> TM21AW	<p><b>BLENDE 1M</b></p> <ul style="list-style-type: none"> <li>- zur Ausfüllung von leeren Stellen</li> <li>- entspricht EN 60669-1</li> <li>- Antibakterienschutz gemäß JIS Z 2801</li> </ul> <p><b>BLANK 1M</b></p> <ul style="list-style-type: none"> <li>- blank modul to fill up empty spaces</li> <li>- in accordance with EN 60669-1</li> <li>- antibacterial protection in accordance with JIS Z 2801</li> </ul>	
	<input type="checkbox"/> TM22AW	<p><b>BLENDE 2M</b></p> <ul style="list-style-type: none"> <li>- zur Ausfüllung von leeren Stellen</li> <li>- entspricht EN 60669-1</li> <li>- Antibakterienschutz gemäß JIS Z 2801</li> </ul> <p><b>BLANK 2M</b></p> <ul style="list-style-type: none"> <li>- blank modul to fill up empty spaces</li> <li>- in accordance with EN 60669-1</li> <li>- antibacterial protection in accordance with JIS Z 2801</li> </ul>	



□ VM10AW

**STECKDOSE SCHUKO+KS 2P+E 16A 250V~ 2M**

- Steckdose mit Schutzkontakt
- 16A 250V~, Typ VM10
- entspricht IEC 60884-1, CEE7
- Schraubklemmen 1,5-2,5 mm<sup>2</sup>
- Steckdose mit erhöhtem Berührungsschutz
- Antibakterienschutz gemäß JIS Z 2801

**SOCKET SCHUKO+KS 2P+E 16A 250V~ 2M**

- 2P+E schuko
- 16A 250V~, type VM10
- in accordance with IEC 60884-1, CEE7
- screw contacts 1.5-2.5 mm<sup>2</sup>
- shuttered live contacts
- antibacterial protection in accordance with JIS Z 2801



□ VM11AW

**STECKDOSE SCHUKO+KS+KLAPPDECKEL 2P+E 16A 250V~ 2M**

- Steckdose mit Schutzkontakt mit Klappdeckel
- 16A 250V~, Typ VM11
- entspricht IEC 60884-1, CEE7
- Schraubklemmen 1,5-2,5 mm<sup>2</sup>
- Steckdose mit erhöhtem Berührungsschutz
- Antibakterienschutz gemäß JIS Z 2801

**SOCKET SCHUKO+KS+COVER**

- 2P+E schuko+cover
- 16A 250V~, type VM11
- in accordance with IEC 60884-1, CEE7
- screw contacts 1.5-2.5 mm<sup>2</sup>
- shuttered live contacts
- antibacterial protection in accordance with JIS Z 2801



□ VM20AW

**STECKDOSE EURO+KS 2P 10A 250V~ 1M**

- 2P Eurosteckdose
- 10A 250V~, Typ VM20
- entspricht IEC 60884-1, CEE7
- Schraubklemmen 1,5-2,5 mm<sup>2</sup>
- Steckdose mit erhöhtem Berührungsschutz
- Antibakterienschutz gemäß JIS Z 2801

**SOCKET EURO+KS 2P 10A 250V~ 1M**

- 2P Euro
- 10A 250V~, type VM20
- in accordance with IEC 60884-1, CEE7
- screw contacts 1.5-2.5 mm<sup>2</sup>
- shuttered live contacts
- antibacterial protection in accordance with JIS Z 2801



□ KM11AW

**TV-ENDDOSE 1dB 1M**

- TV-Enddose
- Übertragungsbandbreite 5÷2400 MHz
- Dämpfung < 1 dB
- entspricht EN 50083-1
- Schraubklemmen
- Antibakterienschutz gemäß JIS Z 2801

**SOCKET TV END-LINE 1dB 1M**

- TV end-line
- frequency range 5÷2400 MHz
- reduction < 1 dB
- in accordance with EN 50083-1
- screw contacts
- antibacterial protection in accordance with JIS Z 2801

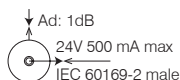

□ KM35AW

**ADAPTER KS 1M**

- KS – keystone-Befestigungsstandard
- AMP, Avaya, Brandrex, FMT, Mfico, Tyco, ...
- ohne Kommunikationsmodul
- Antibakterienschutz gemäß JIS Z 2801

**ADAPTER KS 1M**

- KS keystone fixing standard
- AMP, Avaya, Brandrex, FMT, Mfico, Tyco, ...
- communication module not included
- antibacterial protection in accordance with JIS Z 2801

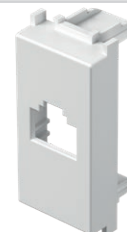

## A N T I B A C T E R I A L P R O G R A M M M O D U L



OS20AW

#### RAHMEN SOFT 2M

- dekorativer Rahmen SOFT 2M
- entspricht EN 60669-1
- Antibakterienschutz gemäß JIS Z 2801

#### COVER PLATE SOFT 2M

- decorative cover plate SOFT 2M
- in accordance with EN 60669-1
- antibacterial protection in accordance with JIS Z 2801



OS24AW

#### RAHMEN SOFT 2x2M

- dekorativer Rahmen SOFT 2x2M
- Horizontal- oder Vertikalmontage
- entspricht EN 60669-1
- Antibakterienschutz gemäß JIS Z 2801

#### COVER PLATE SOFT 2x2M

- decorative cover plate SOFT 2x2M
- horizontal or vertical mounting
- in accordance with EN 60669-1
- antibacterial protection in accordance with JIS Z 2801



OS26AW

#### RAHMEN SOFT 3x2M

- dekorativer Rahmen SOFT 3x2M
- Horizontal- oder Vertikalmontage
- entspricht EN 60669-1
- Antibakterienschutz gemäß JIS Z 2801

#### COVER PLATE SOFT 3x2M

- decorative cover plate SOFT 3x2M
- horizontal or vertical mounting
- in accordance with EN 60669-1
- antibacterial protection in accordance with JIS Z 2801



OS30AW

#### RAHMEN SOFT 3M

- dekorativer Rahmen SOFT 3M
- entspricht EN 60669-1
- Antibakterienschutz gemäß JIS Z 2801

#### COVER PLATE SOFT 3M

- decorative cover plate SOFT 3M
- in accordance with EN 60669-1
- antibacterial protection in accordance with JIS Z 2801



OS40AW

#### RAHMEN SOFT 4M

- dekorativer Rahmen SOFT 4M
- entspricht EN 60669-1
- Antibakterienschutz gemäß JIS Z 2801

#### COVER PLATE SOFT 4M

- decorative cover plate SOFT 4M
- in accordance with EN 60669-1
- antibacterial protection in accordance with JIS Z 2801

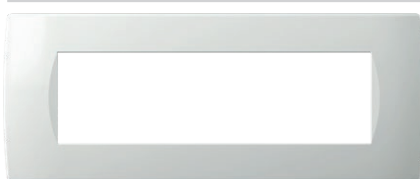

OS70AW

#### RAHMEN SOFT 7M

- dekorativer Rahmen SOFT 7M
- entspricht EN 60669-1
- Antibakterienschutz gemäß JIS Z 2801

#### COVER PLATE SOFT 7M

- decorative cover plate SOFT 7M
- in accordance with EN 60669-1
- antibacterial protection in accordance with JIS Z 2801

Holz  
wood

WB Bambus  
bamboo



WW Nuss  
walnut

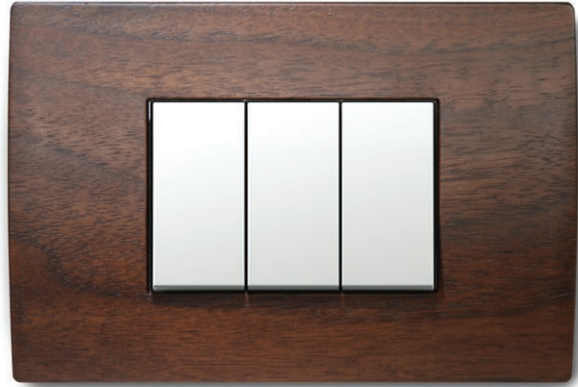

WM Ahorn  
maple



WE Wenge  
wenge

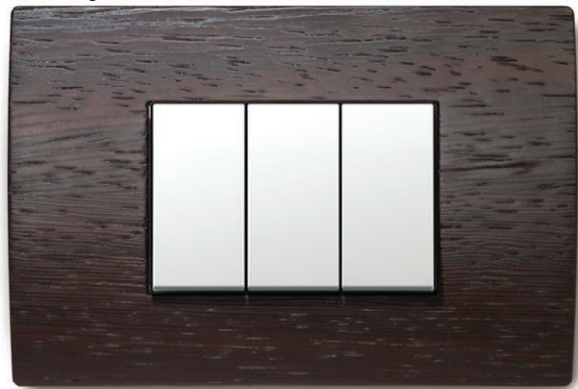

**Die Natur ist einzigartig und wertvoll, so wie unsere Rahmen, unter denen es keine zwei gleiche gibt.**

*Wir können bei den Holzrahmen keine Beanstandungen wegen der Unterschiede im Aussehen und Unterscheidung untereinander berücksichtigen berücksichtigen.*

**Nature is unique and precious, as our decorative cover plates where no two are the same.**

*Complaints about wooden decorative cover plate's diverse appearance and differentiation cannot be considered.*

## COVER PLATES PURE OP

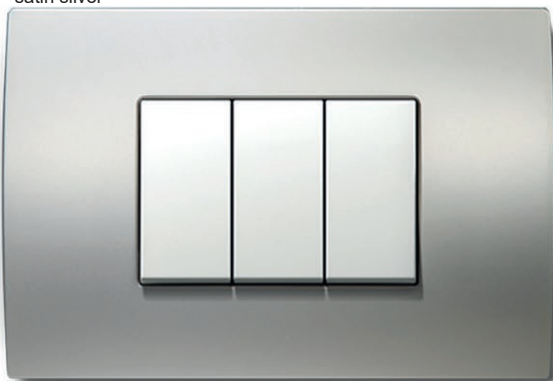
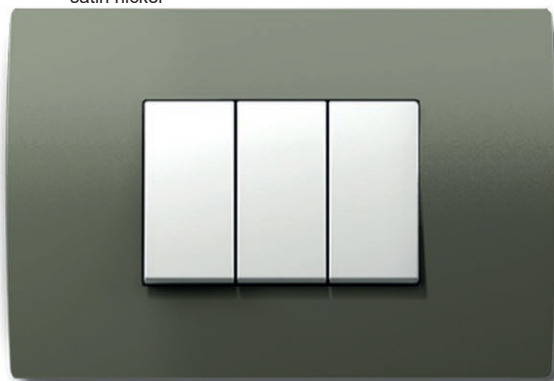
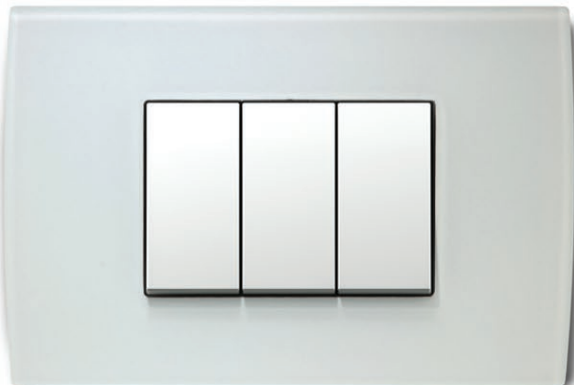
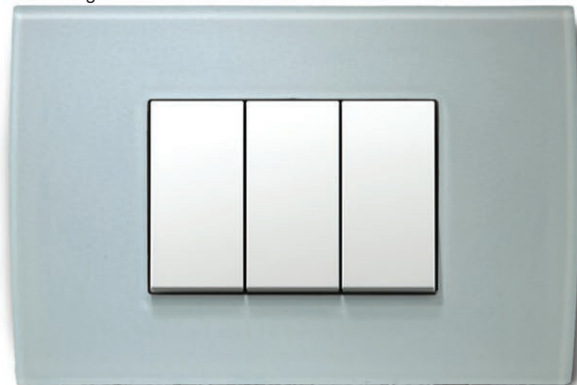
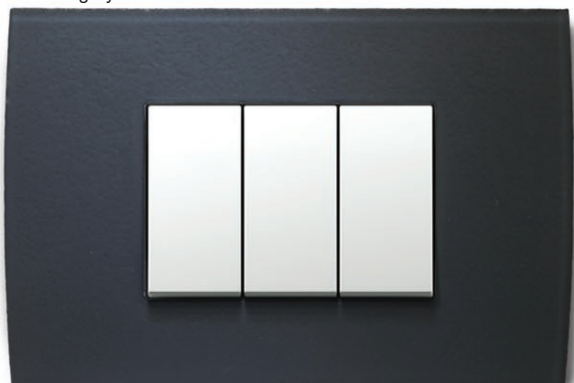
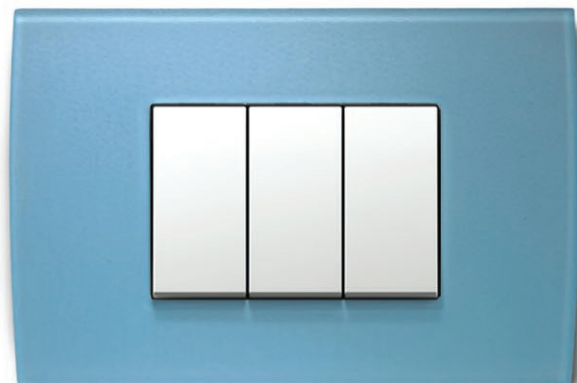
Metall  
metalMH geschmiedeter Stahl  
hammered steelME geätztes Eisen  
etched ironMS Satinsilber  
satin silverMN satin Nickel  
satin nickelGlas  
glassGW eisweiß  
ice whiteGG eisgrün  
ice greenGY eisgrau  
ice greyGB eisblau  
ice blue



OP30

WB

Typ type	Bezeichnung description	Größe size	Farbe colour
OP13	RAHMEN PURE COVER PLATE PURE	1/3M	MH geschmiedeter Stahl hammered steel WB Bambus bamboo GW eisweiß ice white
OP20	RAHMEN PURE COVER PLATE PURE	2M	ME geätztes Eisen etched iron WW Nuss walnut GG eisgrün ice green
OP23	RAHMEN PURE COVER PLATE PURE	2/3M	MS Satinsilber satin silver WM Ahorn maple GY eisgrau ice grey
...	...	...	MN satin Nickel satin nickel WE Wenge wenge GB eisblau ice blue



- |    |        |    |        |
|----|--------|----|--------|
| MH | OP20MH | WB | OP20WB |
| ME | OP20ME | WW | OP20WW |
| MS | OP20MS | WM | OP20WM |
| MN | OP20MN | WE | OP20WE |
|    |        | GW | OP20GW |
|    |        | GG | OP20GG |
|    |        | GY | OP20GY |
|    |        | GB | OP20GB |

**RAHMEN PURE 2M**

- dekorativer Rahmen PURE 2M  
- entspricht EN 60669-1  
- nur in Verbindung mit Montageträger NM24 oder NM25

**COVER PLATE PURE 2M**

- decorative cover plate PURE 2M  
- in accordance with EN 60669-1  
- only in combination with mounting frame NM24 or NM25

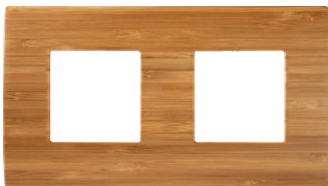

- |    |        |    |        |
|----|--------|----|--------|
| MH | OP24MH | WB | OP24WB |
| ME | OP24ME | WW | OP24WW |
| MS | OP24MS | WM | OP24WM |
| MN | OP24MN | WE | OP24WE |
|    |        | GW | OP24GW |
|    |        | GG | OP24GG |
|    |        | GY | OP24GY |
|    |        | GB | OP24GB |

**RAHMEN PURE 2x2M**

- dekorativer Rahmen PURE 2x2M  
- Horizontal- oder Vertikalmontage  
- entspricht EN 60669-1  
- nur in Verbindung mit Montageträger NM24 oder NM25

**COVER PLATE PURE 2x2M**

- decorative cover plate PURE 2x2M  
- horizontal or vertical mounting  
- in accordance with EN 60669-1  
- only in combination with mounting frames NM24 or NM25



- |    |        |    |        |
|----|--------|----|--------|
| MH | OP26MH | WB | OP26WB |
| ME | OP26ME | WW | OP26WW |
| MS | OP26MS | WM | OP26WM |
| MN | OP26MN | WE | OP26WE |
|    |        | GW | OP26GW |
|    |        | GG | OP26GG |
|    |        | GY | OP26GY |
|    |        | GB | OP26GB |

**RAHMEN PURE 3x2M**

- dekorativer Rahmen PURE 3x2M  
- Horizontal- oder Vertikalmontage  
- entspricht EN 60669-1  
- nur in Verbindung mit Montageträger NM24 oder NM25

**COVER PLATE PURE 3x2M**

- decorative cover plate PURE 3x2M  
- horizontal or vertical mounting  
- in accordance with EN 60669-1  
- only in combination with mounting frames NM24 or NM25



- |    |        |    |        |
|----|--------|----|--------|
| MH | OP28MH | WB | OP28WB |
| ME | OP28ME | WW | OP28WW |
| MS | OP28MS | WM | OP28WM |
| MN | OP28MN | WE | OP28WE |
|    |        | GW | OP28GW |
|    |        | GG | OP28GG |
|    |        | GY | OP28GY |
|    |        | GB | OP28GB |

**RAHMEN PURE 4x2M**

- dekorativer Rahmen PURE 4x2M  
- Horizontal- oder Vertikalmontage  
- entspricht EN 60669-1  
- nur in Verbindung mit Montageträger NM24 oder NM25













**COVER PLATE PURE 4x2M**

- decorative cover plate PURE 4x2M  
- horizontal or vertical mounting  
- in accordance with EN 60669-1  
- only in combination with mounting frames NM24 or NM25



## COVER PLATES PURE OP



 OP30MH	 OP30WB
 OP30ME	 OP30WW
 OP30MS	 OP30WM
 OP30MN	 OP30WE
	 OP30GW
	 OP30GG
	 OP30GY
	 OP30GB









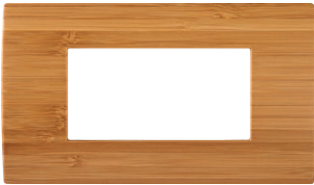



## RAHMEN PURE 3M

- dekorativer Rahmen PURE 3M  
- entspricht EN 60669-1

## COVER PLATE PURE 3M

- decorative cover plate PURE 3M  
- in accordance with EN 60669-1



 OP40MH	 OP40WB
 OP40ME	 OP40WW
 OP40MS	 OP40WM
 OP40MN	 OP40WE
	 OP40GW
	 OP40GG
	 OP40GY
	 OP40GB













## RAHMEN PURE 4M

- dekorativer Rahmen PURE 4M  
- entspricht EN 60669-1

## COVER PLATE PURE 4M

- decorative cover plate PURE 4M  
- in accordance with EN 60669-1



 OP70MH	 OP70WB
 OP70ME	 OP70WW
 OP70MS	 OP70WM
 OP70MN	 OP70WE
	 OP70GW
	 OP70GG
	 OP70GY
	 OP70GB













## RAHMEN PURE 7M

- dekorativer Rahmen PURE 7M  
- entspricht EN 60669-1

## COVER PLATE PURE 7M

- decorative cover plate PURE 7M  
- in accordance with EN 60669-1



 OP13MH	 OP13WB
 OP13ME	 OP13WW
 OP13MS	 OP13WM
 OP13MN	 OP13WE
	 OP13GW
	 OP13GG
	 OP13GY
	 OP13GB













## RAHMEN PURE 1/3M

- dekorativer Rahmen PURE 1/3M  
- entspricht EN 60669-1

## COVER PLATE PURE 1/3M

- decorative cover plate PURE 1/3M  
- in accordance with EN 60669-1



 OP23MH	 OP23WB
 OP23ME	 OP23WW
 OP23MS	 OP23WM
 OP23MN	 OP23WE
	 OP23GW
	 OP23GG
	 OP23GY
	 OP23GB

## RAHMEN PURE 2/3M

- dekorativer Rahmen PURE 2/3M  
- entspricht EN 60669-1

## COVER PLATE PURE 2/3M

- decorative cover plate PURE 2/3M  
- in accordance with EN 60669-1

basic  
basic

PW weiß-glänzend  
polar white

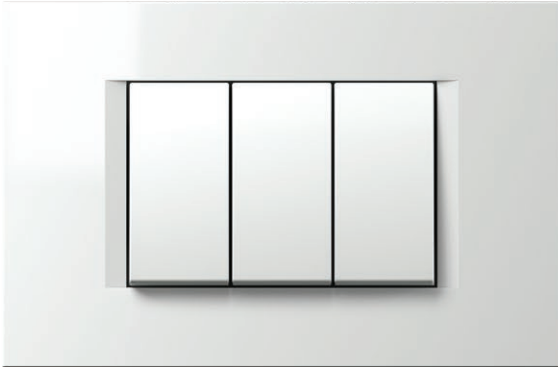

IW beige-glänzend  
ivory white

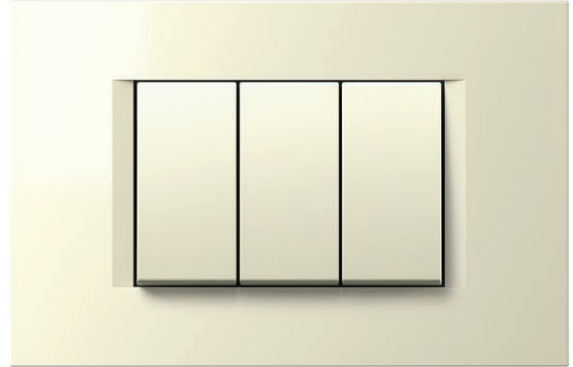

ES silber-matt  
elox silver



SB schwarz-matt  
soft touch black

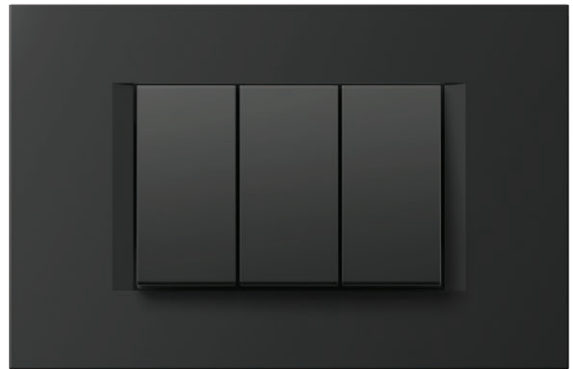

## COVER PLATES LINE OL

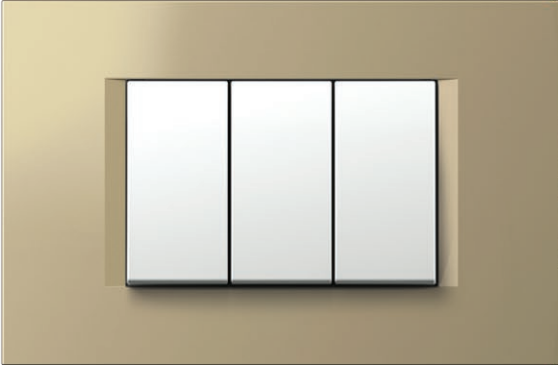
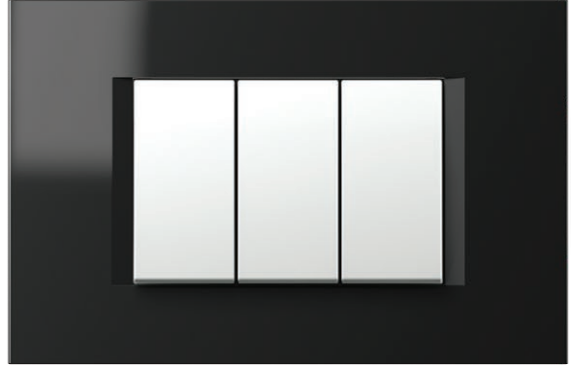
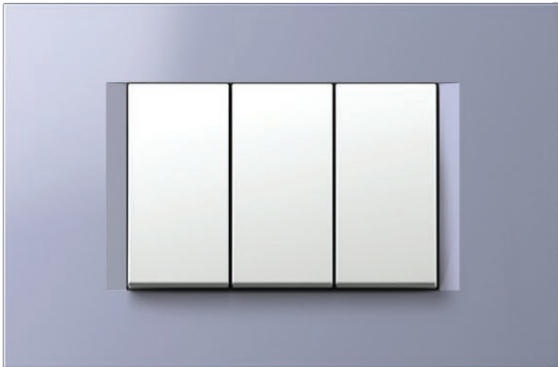
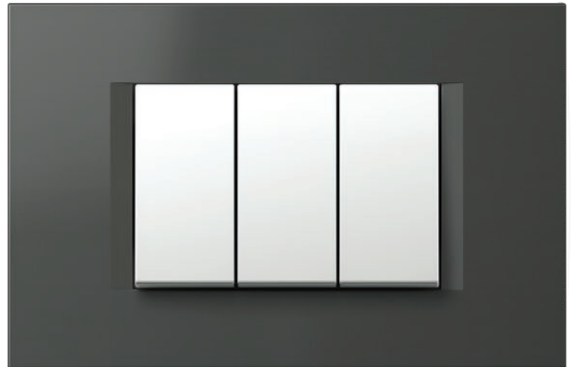
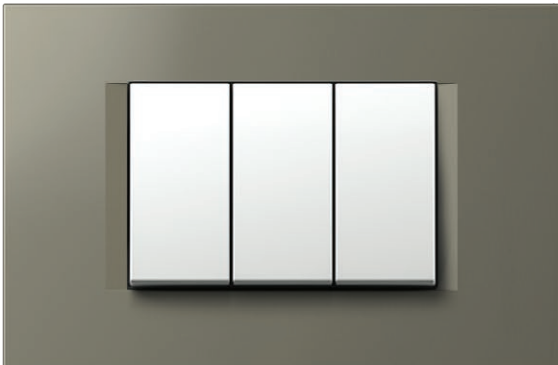
dekor  
decorSG sandgold  
sand goldNB schwarz-glänzend  
night blackIB blau-matt  
impulse blueAT anthrazit  
anthraciteTI titan  
titaniumSW steinweiß  
stone white

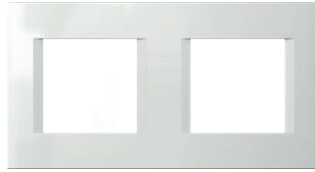

OL30

PW

Typ type	Bezeichnung description	Größe size	Farbe colour												
OL10	RAHMEN LINE COVER PLATE LINE	1/2M	<table border="0"> <tr> <td></td> <td>PW weiß-glänzend polar white</td> <td></td> <td>SG gold-matt sand gold</td> <td></td> <td>AT anthrazit anthracite</td> </tr> </table>		PW weiß-glänzend polar white		SG gold-matt sand gold		AT anthrazit anthracite						
	PW weiß-glänzend polar white		SG gold-matt sand gold		AT anthrazit anthracite										
OL13	RAHMEN LINE COVER PLATE LINE	1/3M	<table border="0"> <tr> <td></td> <td>IW beige-glänzend ivory white</td> <td></td> <td>NB schwarz-glänzend night black</td> <td></td> <td>TI titan titanium</td> </tr> </table>		IW beige-glänzend ivory white		NB schwarz-glänzend night black		TI titan titanium						
	IW beige-glänzend ivory white		NB schwarz-glänzend night black		TI titan titanium										
OL20	RAHMEN LINE COVER PLATE LINE	2M	<table border="0"> <tr> <td></td> <td>ES silber-matt elox silver</td> <td></td> <td>IB blau-matt impulse blue</td> <td></td> <td>SW steinweiß stone white</td> </tr> <tr> <td></td> <td>SB schwarz-matt soft touch black</td> <td></td> <td></td> <td></td> <td></td> </tr> </table>		ES silber-matt elox silver		IB blau-matt impulse blue		SW steinweiß stone white		SB schwarz-matt soft touch black				
	ES silber-matt elox silver		IB blau-matt impulse blue		SW steinweiß stone white										
	SB schwarz-matt soft touch black														
:	:	:													
:	:	:													



**RAHMEN LINE 2M**



	OL20PW		OL20SG
	OL20IW		OL20NB
	OL20ES		OL20IB
	OL20SB		OL20AT
			OL20TI
			OL20SW

- dekorativer Rahmen LINE 2M  
- entspricht EN 60669-1

**COVER PLATE LINE 2M**

- decorative cover plate LINE 2M  
- in accordance with EN 60669-1

**RAHMEN LINE 2x2M**



	OL24PW		OL24SG
	OL24IW		OL24NB
	OL24ES		OL24IB
	OL24SB		OL24AT
			OL24TI
			OL24SW

- dekorativer Rahmen LINE 2x2M  
- Horizontal- oder Vertikalmontage  
- entspricht EN 60669-1

**COVER PLATE LINE 2x2M**

- decorative cover plate LINE 2x2M  
- horizontal or vertical mounting  
- in accordance with EN 60669-1

**RAHMEN LINE 3x2M**



	OL26PW		OL26SG
	OL26IW		OL26NB
	OL26ES		OL26IB
	OL26SB		OL26AT
			OL26TI
			OL26SW

- dekorativer Rahmen LINE 3x2M  
- Horizontal- oder Vertikalmontage  
- entspricht EN 60669-1

**COVER PLATE LINE 3x2M**

- decorative cover plate LINE 3x2M  
- horizontal or vertical mounting  
- in accordance with EN 60669-1

**RAHMEN LINE 4x2M**



	OL28PW		OL28SG
	OL28IW		OL28NB
	OL28ES		OL28IB
	OL28SB		OL28AT
			OL28TI
			OL28SW

- dekorativer Rahmen LINE 4x2M  
- Horizontal- oder Vertikalmontage  
- entspricht EN 60669-1

**COVER PLATE LINE 4x2M**

- decorative cover plate LINE 4x2M  
- horizontal or vertical mounting  
- in accordance with EN 60669-1

**RAHMEN LINE 5x2M**

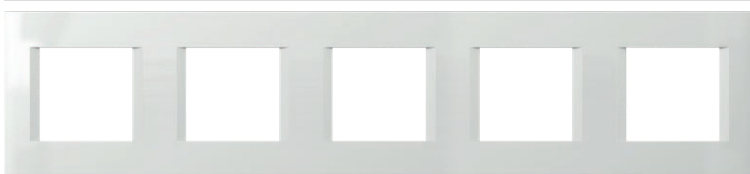

	OL29PW
	OL29IW
	OL29ES
	OL29SB
	OL29AT
	OL29TI

- dekorativer Rahmen LINE 5x2M  
- Horizontal- oder Vertikalmontage  
- entspricht EN 60669-1

**COVER PLATE LINE 5x2M**

- decorative cover plate LINE 5x2M  
- horizontal or vertical mounting  
- in accordance with EN 60669-1

## COVER PLATES LINE OL

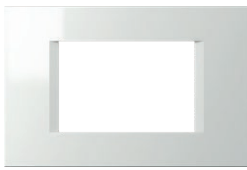

 OL30PW	 OL30SG
 OL30IW	 OL30NB
 OL30ES	 OL30IB
 OL30SB	 OL30AT
	 OL30TI
	 OL30SW











**RAHMEN LINE 3M**

- dekorativer Rahmen LINE 3M  
- entspricht EN 60669-1

**COVER PLATE LINE 3M**

- decorative cover plate LINE 3M  
- in accordance with EN 60669-1



 OL40PW	 OL40SG
 OL40IW	 OL40NB
 OL40ES	 OL40IB
 OL40SB	 OL40AT
	 OL40TI
	 OL40SW











**RAHMEN LINE 4M**

- dekorativer Rahmen LINE 4M  
- entspricht EN 60669-1

**COVER PLATE LINE 4M**

- decorative cover plate LINE 4M  
- in accordance with EN 60669-1



 OL70PW	 OL70SG
 OL70IW	 OL70NB
 OL70ES	 OL70IB
 OL70SB	 OL70AT
	 OL70TI
	 OL70SW



**RAHMEN LINE 7M**

- dekorativer Rahmen LINE 7M  
- entspricht EN 60669-1

**COVER PLATE LINE 7M**

- decorative cover plate LINE 7M  
- in accordance with EN 60669-1



 OL10PW	 OL10SG
 OL10IW	 OL10NB
 OL10ES	 OL10IB
 OL10SB	 OL10AT
	 OL10TI
	 OL10SW

**RAHMEN LINE 1/2M**

- dekorativer Rahmen LINE 1/2M  
- entspricht EN 60669-1

**COVER PLATE LINE 1/2M**

- decorative cover plate LINE 1/2M  
- in accordance with EN 60669-1

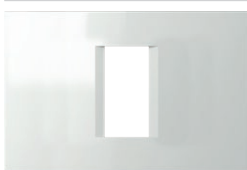

 OL13PW	 OL13SG
 OL13IW	 OL13NB
 OL13ES	 OL13IB
 OL13SB	 OL13AT
	 OL13TI
	 OL13SW











**RAHMEN LINE 1/3M**

- dekorativer Rahmen LINE 1/3M  
- entspricht EN 60669-1

**COVER PLATE LINE 1/3M**

- decorative cover plate LINE 1/3M  
- in accordance with EN 60669-1



 OL23PW	 OL23SG
 OL23IW	 OL23NB
 OL23ES	 OL23IB
 OL23SB	 OL23AT
	 OL23TI
	 OL23SW

**RAHMEN LINE 2/3M**

- dekorativer Rahmen LINE 2/3M  
- entspricht EN 60669-1

**COVER PLATE LINE 2/3M**

- decorative cover plate LINE 2/3M  
- in accordance with EN 60669-1

basic  
basic

PW weiß-glänzend  
polar white

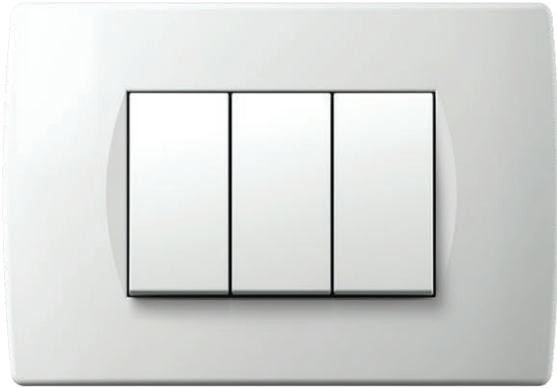

IW beige-glänzend  
ivory white

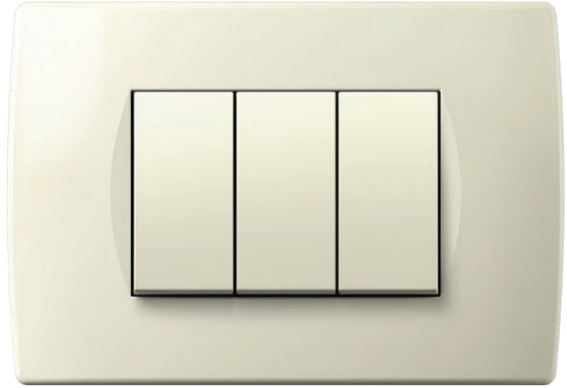

ES silber-matt  
elox silver

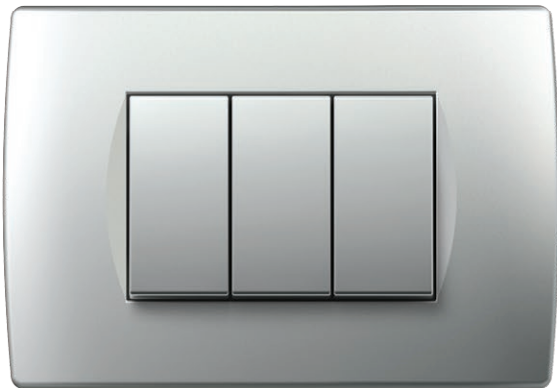

SB schwarz-matt  
soft touch black

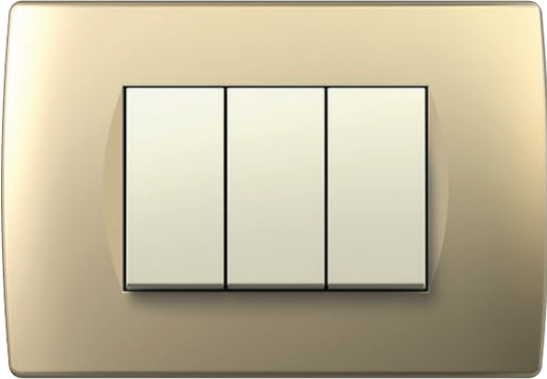
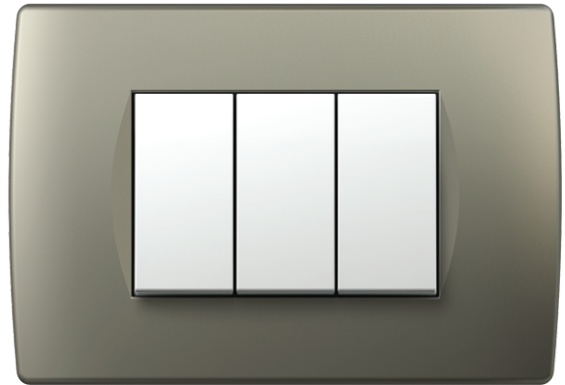
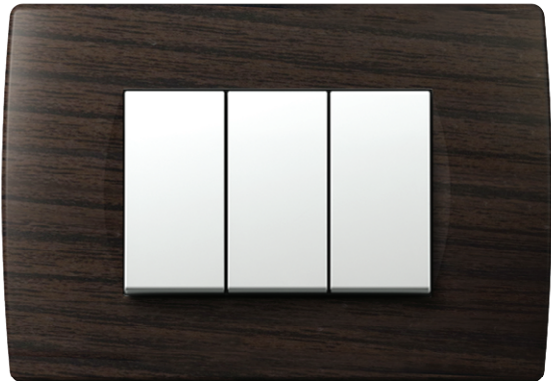

## COVER PLATES SOFT OS

dekor  
decorSG sandgold  
sand goldNB schwarz-glänzend  
night blackAT anthrazit  
anthraciteTI titan  
titaniumWE Wenge  
wengeWW Nuss  
walnut

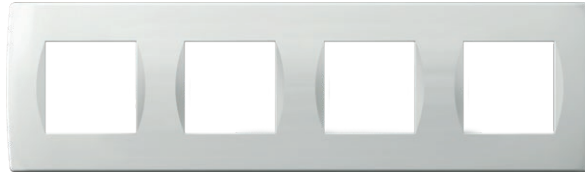
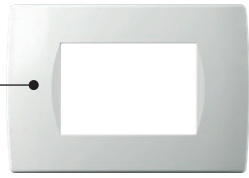

OS30

PW

Typ type	Bezeichnung description	Größe size	Farbe colour												
OS10	RAHMEN SOFT COVER PLATE SOFT	1/2M	<table border="0"> <tr> <td></td> <td>PW weiß-glänzend polar white</td> <td></td> <td>SG sandgold sand gold</td> <td></td> <td>WW Nuss walnut</td> </tr> </table>		PW weiß-glänzend polar white		SG sandgold sand gold		WW Nuss walnut						
	PW weiß-glänzend polar white		SG sandgold sand gold		WW Nuss walnut										
OS13	RAHMEN SOFT COVER PLATE SOFT	1/3M	<table border="0"> <tr> <td></td> <td>IW beige-glänzend ivory white</td> <td></td> <td>NB sch.-glänzend night black</td> <td></td> <td>WE Wenge wenge</td> </tr> </table>		IW beige-glänzend ivory white		NB sch.-glänzend night black		WE Wenge wenge						
	IW beige-glänzend ivory white		NB sch.-glänzend night black		WE Wenge wenge										
OS20	RAHMEN SOFT COVER PLATE SOFT	2M	<table border="0"> <tr> <td></td> <td>ES silber-matt elox silver</td> <td></td> <td>AT anthrazit anthracite</td> <td></td> <td></td> </tr> <tr> <td></td> <td>SB schwarz-matt soft touch black</td> <td></td> <td>TI titan titanium</td> <td></td> <td></td> </tr> </table>		ES silber-matt elox silver		AT anthrazit anthracite				SB schwarz-matt soft touch black		TI titan titanium		
	ES silber-matt elox silver		AT anthrazit anthracite												
	SB schwarz-matt soft touch black		TI titan titanium												
...	...	...	...												



	OS20PW		OS20SG
	OS20IW		OS20NB
	OS20ES		OS20AT
	OS20SB		OS20TI
			OS20WW
			OS20WE

**RAHMEN SOFT 2M**

- dekorativer Rahmen SOFT 2M
- entspricht EN 60669-1

**COVER PLATE SOFT 2M**

- decorative cover plate SOFT 2M
- in accordance with EN 60669-1



	OS24PW		OS24SG
	OS24IW		OS24NB
	OS24ES		OS24AT
	OS24SB		OS24TI
			OS24WW
			OS24WE

**RAHMEN SOFT 2x2M**

- dekorativer Rahmen SOFT 2x2M
- Horizontal- oder Vertikalmontage
- entspricht EN 60669-1

**COVER PLATE SOFT 2x2M**

- decorative cover plate SOFT 2x2M
- horizontal or vertical mounting
- in accordance with EN 60669-1



	OS26PW		OS26SG
	OS26IW		OS26NB
	OS26ES		OS26AT
	OS26SB		OS26TI
			OS26WW
			OS26WE

**RAHMEN SOFT 3x2M**

- dekorativer Rahmen SOFT 3x2M
- Horizontal- oder Vertikalmontage
- entspricht EN 60669-1

**COVER PLATE SOFT 3x2M**

- decorative cover plate SOFT 3x2M
- horizontal or vertical mounting
- in accordance with EN 60669-1



	OS28PW		OS28SG
	OS28IW		OS28NB
	OS28ES		OS28AT
	OS28SB		OS28TI
			OS28WW
			OS28WE

**RAHMEN SOFT 4x2M**

- dekorativer Rahmen SOFT 4x2M
- Horizontal- oder Vertikalmontage
- entspricht EN 60669-1

**COVER PLATE SOFT 4x2M**

- decorative cover plate SOFT 4x2M
- horizontal or vertical mounting
- in accordance with EN 60669-1



## COVER PLATES SOFT OS



 OS30PW	 OS30SG
 OS30IW	 OS30NB
 OS30ES	 OS30AT
 OS30SB	 OS30TI
	 OS30WW
	 OS30WE





**RAHMEN SOFT 3M**

- dekorativer Rahmen SOFT 3M  
- entspricht EN 60669-1

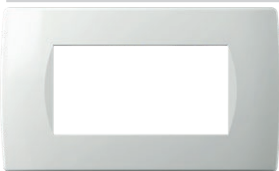
**COVER PLATE SOFT 3M**

- decorative cover plate SOFT 3M  
- in accordance with EN 60669-1



 OS40PW	 OS40SG
 OS40IW	 OS40NB
 OS40ES	 OS40AT
 OS40SB	 OS40TI
	 OS40WW
	 OS40WE



**RAHMEN SOFT 4M**

- dekorativer Rahmen SOFT 4M  
- entspricht EN 60669-1

**COVER PLATE SOFT 4M**

- decorative cover plate SOFT 4M  
- in accordance with EN 60669-1



 OS70PW	 OS70SG
 OS70IW	 OS70NB
 OS70ES	 OS70AT
 OS70SB	 OS70TI
	 OS70WW
	 OS70WE





**RAHMEN SOFT 7M**

- dekorativer Rahmen SOFT 7M  
- entspricht EN 60669-1

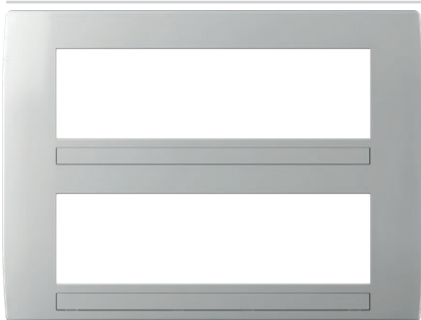
**COVER PLATE SOFT 7M**

- decorative cover plate SOFT 7M  
- in accordance with EN 60669-1



 OS72PW	 OS72AT
 OS72IW	 OS72TI
 OS72ES	
 OS72SB	

**RAHMEN SOFT 2x7M**

- dekorativer Rahmen SOFT 2x7M  
mit Namensschild  
- entspricht EN 60669-1

**COVER PLATE SOFT 2x7M**

- decorative cover plate SOFT 2x7M  
with inscription plate  
- in accordance with EN 60669-1



 OS10PW	 OS10SG
 OS10IW	 OS10NB
 OS10ES	 OS10AT
 OS10SB	 OS10TI
	 OS10WW
	 OS10WE







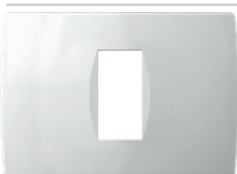

**RAHMEN SOFT 1/2M**

- dekorativer Rahmen SOFT 1/2M  
- entspricht EN 60669-1

**COVER PLATE SOFT 1/2M**

- decorative cover plate SOFT 1/2M  
- in accordance with EN 60669-1



 OS13PW	 OS13SG
 OS13IW	 OS13NB
 OS13ES	 OS13AT
 OS13SB	 OS13TI
	 OS13WW
	 OS13WE









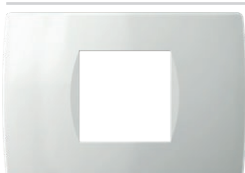

**RAHMEN SOFT 1/3M**

- dekorativer Rahmen SOFT 1/3M  
- entspricht EN 60669-1

**COVER PLATE SOFT 1/3M**

- decorative cover plate SOFT 1/3M  
- in accordance with EN 60669-1



 OS23PW	 OS23SG
 OS23IW	 OS23NB
 OS23ES	 OS23AT
 OS23SB	 OS23TI
	 OS23WW
	 OS23WE

**RAHMEN SOFT 2/3M**

- dekorativer Rahmen SOFT 2/3M  
- entspricht EN 60669-1

**COVER PLATE SOFT 2/3M**

- decorative cover plate SOFT 2/3M  
- in accordance with EN 60669-1



LASERDRUCK AUF RAHMEN

- Laserdruck von beliebigen Symbolen auf gekennzeichnete Stellen
- Fertigung auf Bestellung
- geeignet für Rahmen OL, OS

LASER PRINT ON COVER PLATES

- laser print of any graphics
- made on request
- suitable for cover plates OL, OS



DEKORATION DER RAHMEN

- Muster und Farben nach Wahl
- Fertigung auf Bestellung
- geeignet für Rahmen OL, OS

COVER PLATES DECORATIONS

- customised textures and colours
- made on request
- suitable for cover plates OL, OS

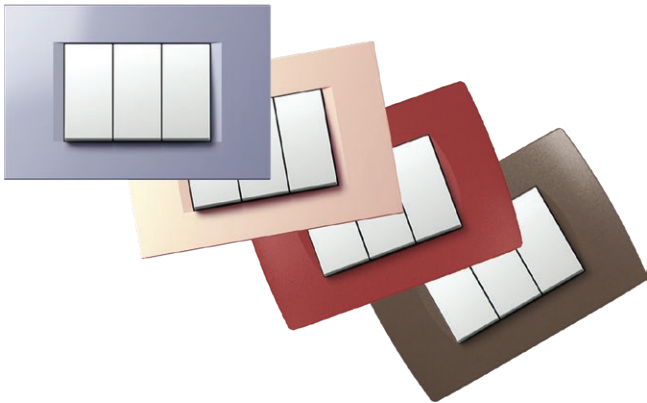

F R A M E S



line  
A x B



soft  
A x B



PURE  
A x B

2M

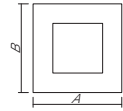

80 x 80 mm

84 x 84 mm

93 x 90 mm

2x2M

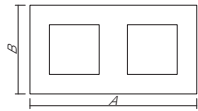

151 x 80 mm

155 x 84 mm

164 x 90 mm

3x2M

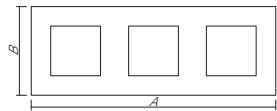

222 x 80 mm

226 x 84 mm

235 x 90 mm

4x2M

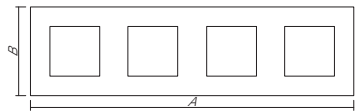

293 x 80 mm

297 x 84 mm

304 x 90 mm



3M

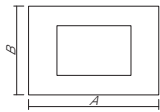

122 x 80 mm

122 x 84 mm

134 x 90 mm

4M

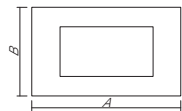

149 x 80 mm

144 x 84 mm

157 x 90 mm

7M

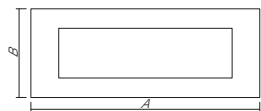

207 x 80 mm

212 x 84 mm

224 x 90 mm

2x7M

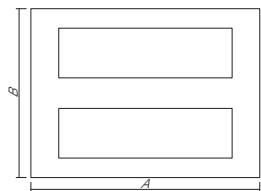

212 x 158 mm



1/2M

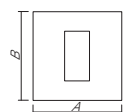

80 x 80 mm

84 x 84 mm

1/3M

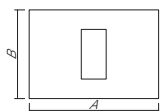

122 x 80 mm

122 x 84 mm

134 x 90 mm

2/3M

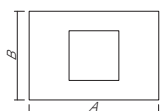

122 x 80 mm

122 x 84 mm

134 x 90 mm

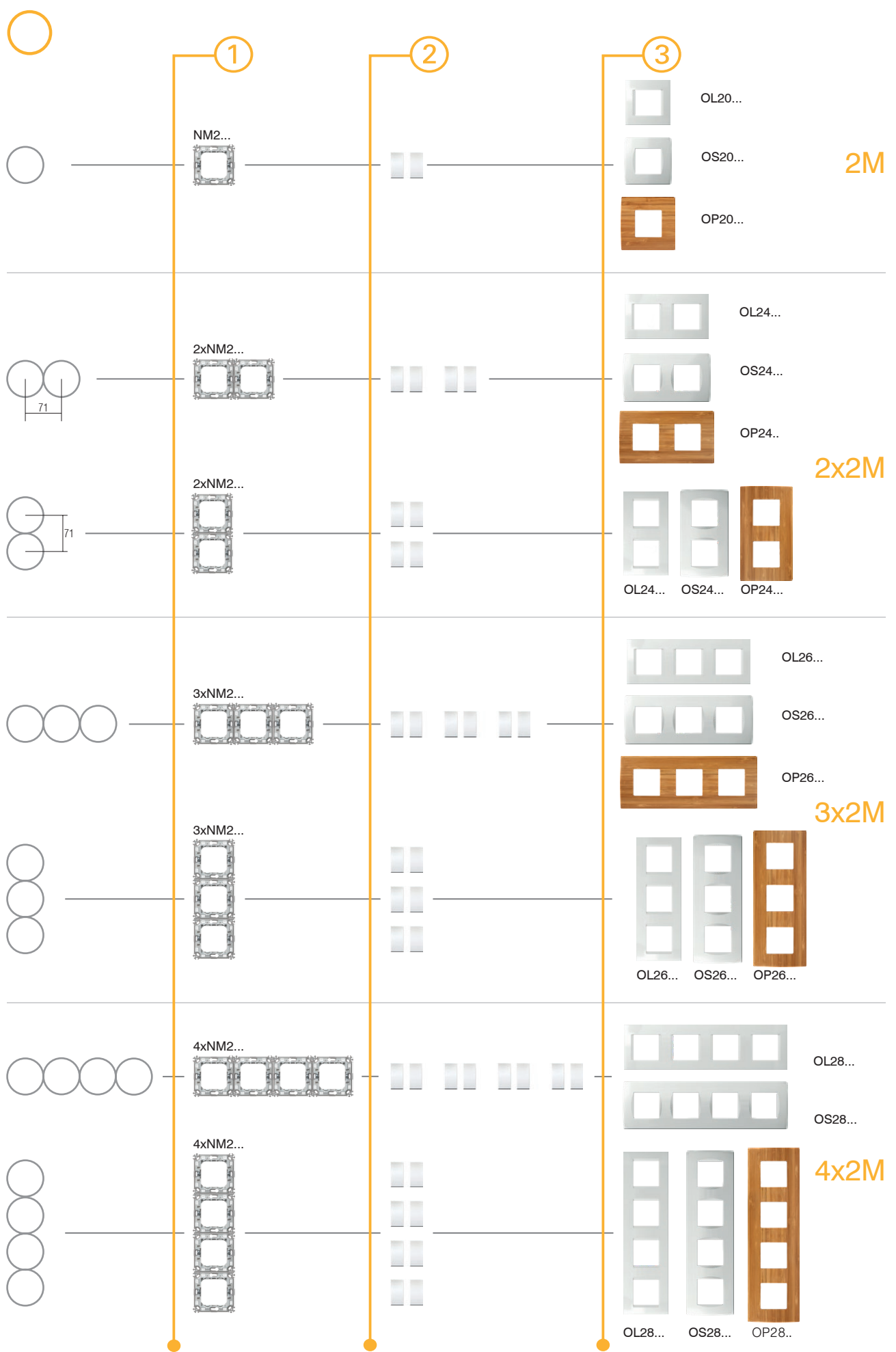

C O M B I N A T I O N S

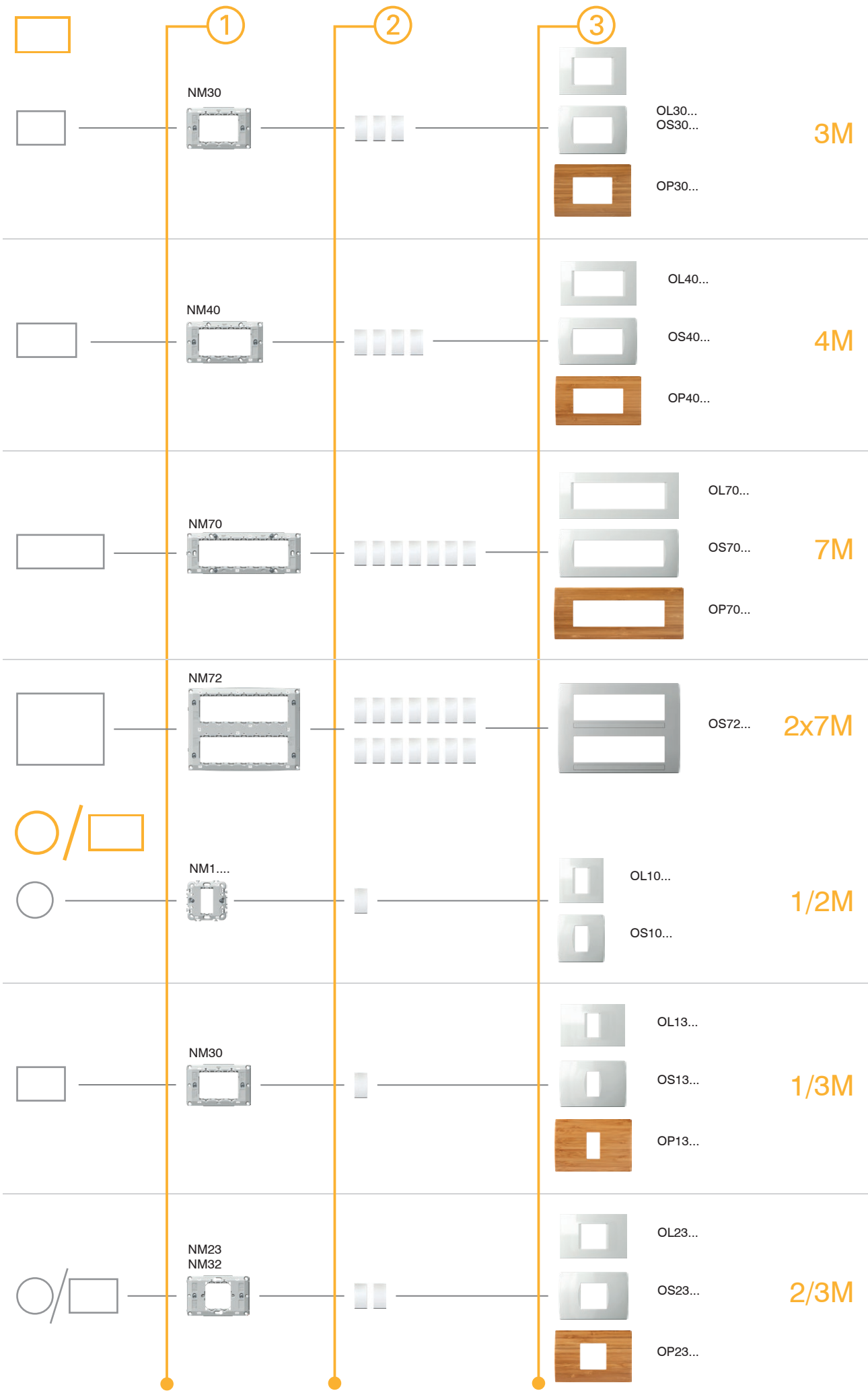

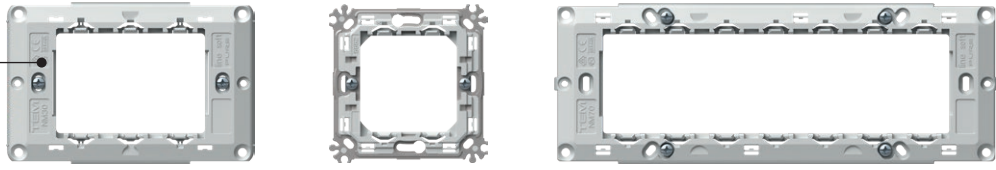

NM30

Typ type	Bezeichnung description	Größe size
NM10	MONTAGETRÄGER MIT KRALLEN MOUNTING FRAME WITH CLAWS	1/2M
NM11	MONTAGETRÄGER OHNE SCHRAUBEN MOUNTING FRAME WITHOUT SCREWS	1/2M
NM20	MONTAGETRÄGER MIT KRALLEN MOUNTING FRAME WITH CLAWS	2M
...	...	...



**MONTAGETRÄGER MIT KRALLEN 2M**

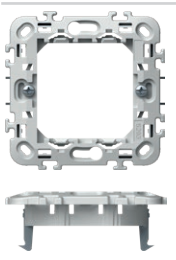

NM20

- Montageträger 2M mit Krallen
- Montage in der Wanddose Ø60 (DE..) mit Krallen
- Ermöglicht Steckmontage 2x2M, 3x2M und 4x2M in Horizontal- bzw. Vertikalrichtung
- geeignet für Rahmen LINE und SOFT
- entspricht EN 60669-1

**MOUNTING FRAME WITH CLAWS 2M**

- mounting frame 2M with claws
- for mounting on boxes Ø60 (DE..) with claws
- possible horizontal or vertical combinations 2x2M, 3x2M and 4x2M
- suitable for assembling with cover plates LINE and SOFT
- in accordance with EN 60669-1

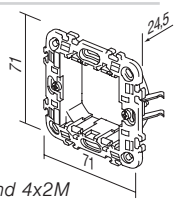

**MONTAGETRÄGER OHNE SCHRAUBEN 2M**

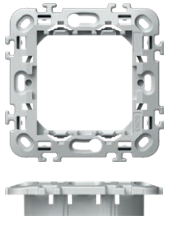

NM21

- Montageträger 2M ohne Schrauben bzw. Krallen
- Montage in der Wanddose Ø60 (HE., BE..) mit Schrauben
- Ermöglicht Steckmontage 2x2M, 3x2M und 4x2M in Horizontal- bzw. Vertikalrichtung
- geeignet für Rahmen LINE und SOFT
- entspricht EN 60669-1

**MOUNTING FRAME WITHOUT SCREWS 2M**

- mounting frame 2M without screws and without claws
- for mounting on boxes Ø60 (HE., BE..) with screws
- possible horizontal or vertical combinations 2x2M, 3x2M and 4x2M
- suitable for assembling with cover plates LINE and SOFT
- in accordance with EN 60669-1

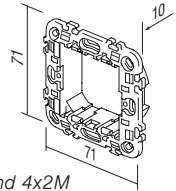

**MONTAGETRÄGER METALL MIT KRALLEN 2M**

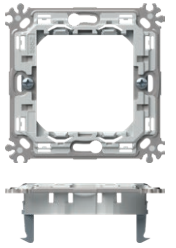

NM24

- Montageträger 2M aus Metall mit Krallen – steife Ausführung
- Montage in der Wanddose Ø60 (DE..) mit Krallen
- Ermöglicht Steckmontage 2x2M, 3x2M und 4x2M in Horizontal- bzw. Vertikalrichtung
- geeignet für Rahmen PURE, LINE und SOFT
- entspricht EN 60669-1

**MOUNTING FRAME METAL WITH CLAWS 2M**

- metal mounting frame 2M with claws - stiff version
- for mounting on boxes Ø60 (DE..) with claws
- possible horizontal or vertical combinations 2x2M, 3x2M and 4x2M
- suitable for assembling with cover plates PURE, LINE and SOFT
- in accordance with EN 60669-1

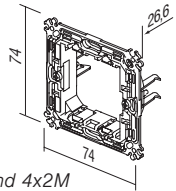

**MONTAGETRÄGER METALL OHNE SCHRAUBEN 2M**

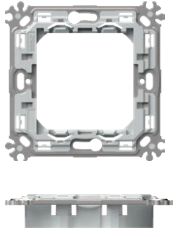

NM25

- Montageträger 2M aus Metall ohne Schrauben bzw. Krallen – steife Ausführung
- Montage in der Wanddose Ø60 (HE., BE..) mit Schrauben
- Ermöglicht Steckmontage 2x2M, 3x2M und 4x2M in Horizontal- bzw. Vertikalrichtung
- geeignet für Rahmen PURE, LINE und SOFT
- entspricht EN 60669-1

**MOUNTING FRAME METAL WITHOUT SCREWS 2M**

- metal mounting frame 2M without screws and without claws - stiff version
- for mounting in boxes Ø60 (HE., BE..) with screws
- possible horizontal or vertical combinations 2x2M, 3x2M and 4x2M
- suitable for assembling with cover plates PURE, LINE and SOFT
- in accordance with EN 60669-1

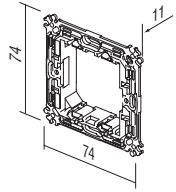

## M O U N T I N G   F R A M E S   N M

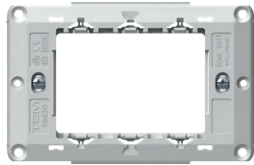

NM30

**MONTAGETRÄGER MIT SCHRAUBEN 3M**

- Montageträger 3M mit Schrauben
- Montage in Rechteckdosen 3M
- geeignet für Rahmen PURE, LINE und SOFT
- entspricht EN 60669-1

*MOUNTING FRAME WITH SCREWS 3M*

- mounting frame 3M with screws
- for mounting on rectangular boxes 3M
- suitable for assembling with cover plates PURE, LINE and SOFT
- in accordance with EN 60669-1

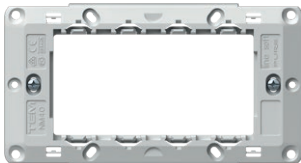
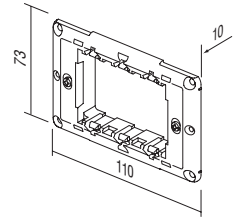

NM40

**MONTAGETRÄGER MIT SCHRAUBEN 4M**

- Montageträger 4M mit Schrauben
- Montage in Rechteckdosen 4M
- geeignet für Rahmen PURE, LINE und SOFT
- entspricht EN 60669-1

*MOUNTING FRAME WITH SCREWS 4M*

- mounting frame 4M with screws
- for mounting on rectangular boxes 4M
- suitable for assembling with cover plates PURE, LINE and SOFT
- in accordance with EN 60669-1

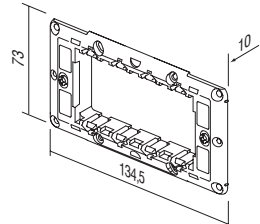

NM70

**MONTAGETRÄGER MIT SCHRAUBEN 7M**

- Montageträger 7M mit Schrauben
- Montage in Rechteckdosen 7M
- geeignet für Rahmen PURE, LINE und SOFT
- entspricht EN 60669-1

*MOUNTING FRAME WITH SCREWS 7M*

- mounting frame 7M with screws
- for mounting on rectangular boxes 7M
- suitable for assembling with cover plates PURE, LINE and SOFT
- in accordance with EN 60669-1

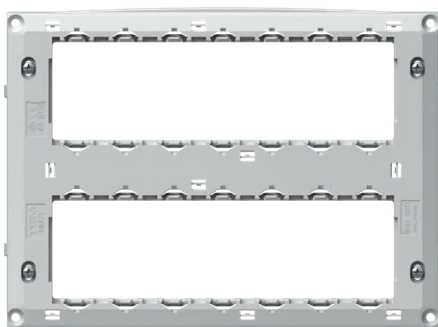
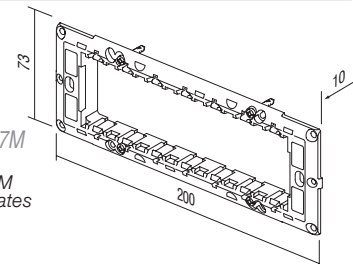

NM72

**MONTAGETRÄGER MIT SCHRAUBEN 2x7M**

- Montageträger 2x7M mit Schrauben
- Montage in Rechteckdosen 2x7M
- geeignet für Rahmen SOFT OS72
- entspricht EN 60669-1

*MOUNTING FRAME WITH SCREWS 2x7M*

- mounting frame 2x7M with screws
- for mounting on rectangular boxes 2x7M
- suitable for assembling with cover plate SOFT OS72
- in accordance with EN 60669-1

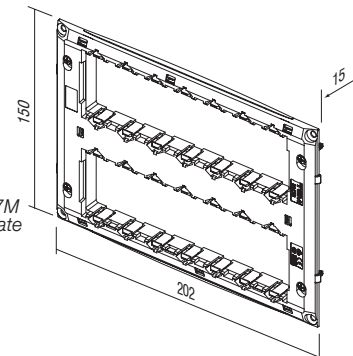

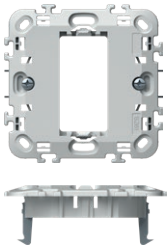

**MONTAGETRÄGER MIT KRALLEN 1/2M**

NM10

- Montageträger 1/2M mit Krallen
- Montage in der Wanddose Ø60 (DE..) mit Krallen
- geeignet für Rahmen LINE und SOFT
- entspricht EN 60669-1

*MOUNTING FRAME WITH CLAWS 1/2M*

- mounting frame 1/2M with claws
- for mounting on boxes Ø60 (DE..) with claws
- suitable for assembling with cover plates LINE and SOFT
- in accordance with EN 60669-1

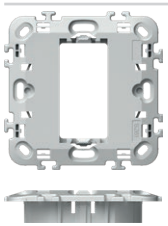
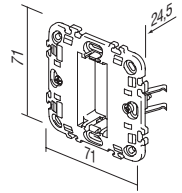

**MONTAGETRÄGER OHNE SCHRAUBEN 1/2M**

NM11

- Montageträger 1/2M ohne Schrauben bzw. Krallen
- Montage in der Wanddose Ø60 (HE.., BE..) mit Schrauben
- geeignet für Rahmen LINE und SOFT
- entspricht EN 60669-1

*MOUNTING FRAME WITHOUT SCREWS 1/2M*

- mounting frame 1/2M without screws and without claws
- for mounting on boxes Ø60 (HE.., BE..) with screws
- suitable for assembling with cover plates LINE and SOFT
- in accordance with EN 60669-1

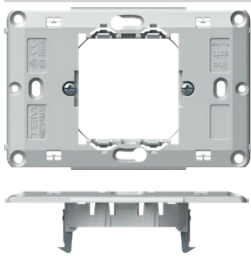
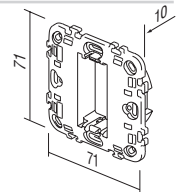

**MONTAGETRÄGER MIT KRALLEN 2/3M**

NM23

- Montageträger 2/3M mit Krallen
- Montage in der Wanddose Ø60 (DE..) mit Krallen
- geeignet für Rahmen PURE, LINE und SOFT
- entspricht EN 60669-1

*MOUNTING FRAME WITH CLAWS 2/3M*

- mounting frame 2/3M with claws
- for mounting on boxes Ø60 (DE..) with claws
- suitable for assembling with cover plates PURE, LINE and SOFT
- in accordance with EN 60669-1

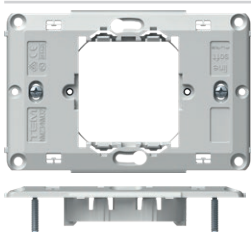
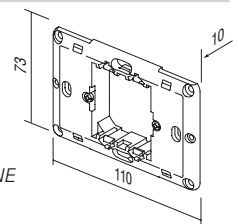

**MONTAGETRÄGER MIT SCHRAUBEN 2/3M**

NM32

- Montageträger 2/3M mit Schrauben
- Montage in Rechteckdosen 3M
- geeignet für Rahmen PURE, LINE und SOFT
- entspricht EN 60669-1

*MOUNTING FRAME WITH SCREWS 2/3M*

- mounting frame 2/3M with screws
- for mounting on rectangular boxes 3M
- suitable for assembling with cover plates PURE, LINE and SOFT
- in accordance with EN 60669-1

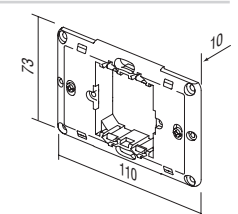





TEM

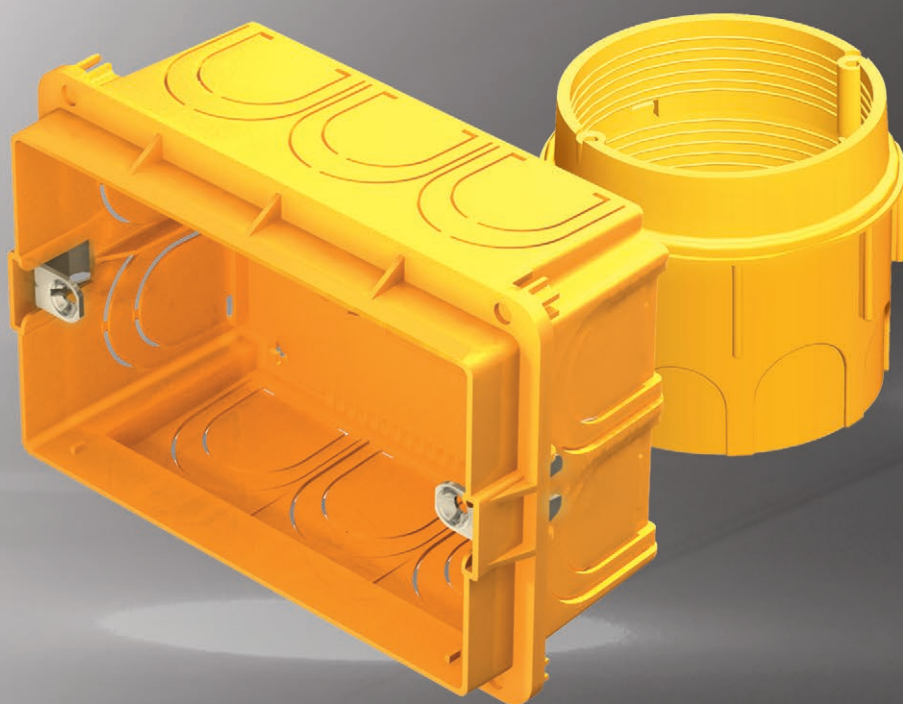

## DOSEN



---

 RUNDDOSEN  
 ROUND BOXES

140

---

 RECHTECKDOSEN  
 RECTANGULAR BOXES

148

---

 ABZWEIGDOSEN  
 JUNCTION BOXES

156

---

 VERDRAHTUNGSZUBEHÖR  
 WIRING ACCESSORIES

158

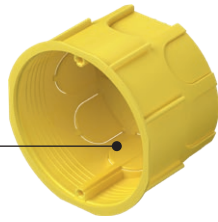

DE12



HE11



BE10

Typ type	Bezeichnung description	Größe size
DE10	RUNDDOSE ZIEGELWAND ROUND BOX BRICK	SM60-01
HE10	RUNDDOSE HOHLWAND ROUND BOX HOLLOW WALL	SM68X40
BE10	RUNDDOSE BETONWAND ROUND BOX CONCRETE	
⋮	⋮	⋮
⋮	⋮	⋮



DE10

**RUNDDOSE ZIEGELWAND SM60-01**

- Durchmesser Ø60 mm, Tiefe 40mm
- 650°C, 500V~
- entspricht IEC 60670-1
- ohne Halogen

**ROUND BOX BRICK SM60-01**

- Ø60, depth 40mm
- 650°C, 500V~
- in accordance with IEC 60670-1
- halogen free

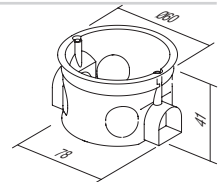

DE11

**RUNDDOSE ZIEGELWAND TIEF SM60-06**

- Durchmesser Ø60 mm, Tiefe 60 mm
- 650°C, 500V~
- entspricht IEC 60670-1
- ohne Halogen

**ROUND BOX BRICK DEEP SM60-06**

- Ø60, depth 60mm
- 650°C, 500V~
- in accordance with IEC 60670-1
- halogen free

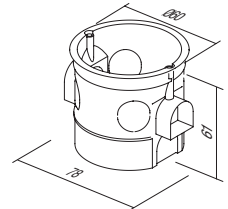

DE30

**ABSTANDSTUTZEN SM60-03**

- für vertikale Mehrfachkombinationen von Dosen SM60-06 bzw. SM60-01 auf einer Distanz von 91 mm
- entspricht IEC 60670-1
- ohne Halogen

**COMBI-CLIP SM60-03**

- for vertical fitting of boxes SM60-06 or SM60-01 on distance 91 mm
- in accordance with IEC 60670-1
- halogen free

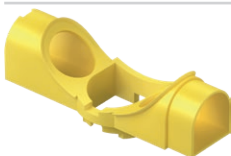
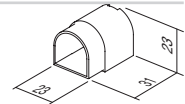

DE31

**ABSTANDSTUTZEN SM60-04**

- für horizontale Mehrfachkombinationen von Dosen SM60-06 bzw. SM60-01 auf einer Distanz von 71mm
- entspricht IEC 60670-1,
- ohne Halogen

**COMBI-CLIP SM60-04**

- for horizontal fitting of boxes SM60-06 or SM60-01 on distance 71mm
- in accordance with IEC 60670-1
- halogen free

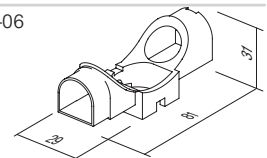

	DE12	<b>RUNDDOSE ZIEGELWAND MD65-46</b> - Durchmesser Ø60 mm, Tiefe 46 mm - 650°C, 500V - entspricht IEC 60670-1 - ohne Halogen	
		<b>ROUND BOX BRICK MD65-46</b> - Ø65, depth 46mm - 650°C, 500V - in accordance with IEC 60670-1 - halogen free	
	DE13	<b>RUNDDOSE ZIEGELWAND TIEF MD65-60</b> - Durchmesser Ø65/60 mm, Tiefe 62mm - 650°C, 500V - entspricht IEC 60670-1 - ohne Halogen	
		<b>ROUND BOX BRICK DEEP MD65-60</b> - Ø65/60, depth 62mm - 650°C, 500V - in accordance with IEC 60670-1 - halogen free	
	DE14	<b>VERLÄNGERUNG FÜR RUNDDOSE ZIEGELWAND MD65-46</b> - Durchmesser Ø65/60 mm, Tiefe 17 mm - 650°C, 500V - entspricht IEC 60670-1 - ohne Halogen	
		<b>ADDITIONAL PIECE FOR MD65-46</b> - Ø65/60, depth 17mm - 650°C, 500V - in accordance with IEC 60670-1 - halogen free	
	DE32	<b>ABSTANDSTUTZEN MD65-71</b> - zur Verbindung von Dosen MD65 auf eine Distanz von 71 mm - entspricht IEC 60670-1 - ohne Halogen	
		<b>COMBI-CLIP MD65-71</b> - for fitting of boxes MD65 on distance 71mm - in accordance with IEC 60670-1 - halogen free	
	DE33	<b>ABSTANDSTUTZEN MD65-91</b> - zur Verbindung von Dosen MD65 auf eine Distanz von 91mm - entspricht IEC 60670-1 - ohne Halogen	
		<b>COMBI-CLIP MD65-91</b> - for fitting of boxes MD65 on distance 91mm - in accordance with IEC 60670-1 - halogen free	
	DE20	<b>FEDERDECKEL 60</b> - Federdeckel für Runddosen Ø60 für DE10, DE11, DE13, DE14 - entspricht IEC 60670-1 - zum Schutz beim Verputzen	
		<b>BOX COVER PROTECTIVE 60</b> - protective cover for box Ø60 for DE10, DE11, DE13, DE14 - in accordance with IEC 60670-1 - box protection during plastering	
	DE21	<b>FEDERDECKEL 65</b> - Federdeckel für Runddosen Ø65 für DE12 - entspricht IEC 60670-1 - zum Schutz beim Verputzen	
		<b>BOX COVER PROTECTIVE 65</b> - protective cover for box Ø65 for DE12 - in accordance with IEC 60670-1 - box protection during plastering	
	DE22	<b>ABDECKUNG DEKORATIV SM60</b> - dekorative Abdeckung für Runddosen Ø60 - entspricht IEC 60670-1 - ohne Halogen	
		<b>BOX COVER DECORATIVE SM60</b> - decorative cover for boxes Ø60 - in accordance with IEC 60670-1 - halogen free	



Montageanleitung /  
assembly instructions

Abstand zwischen Dosen /  
distance between boxes: 71 mm

Abstand zwischen Dosen /  
distance between boxes: 91 mm

DE10,11

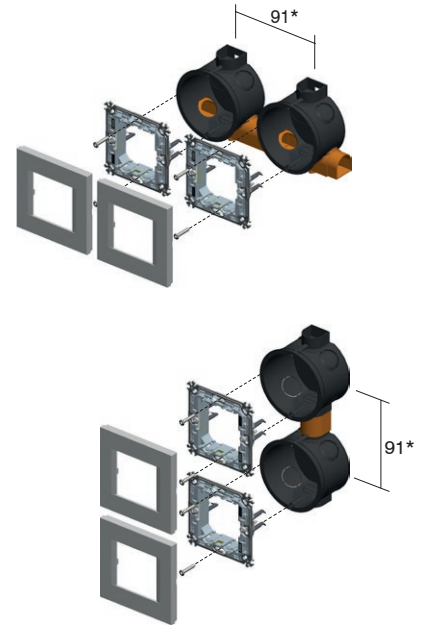
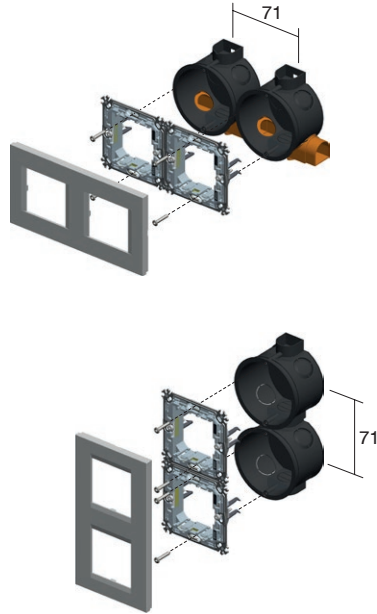
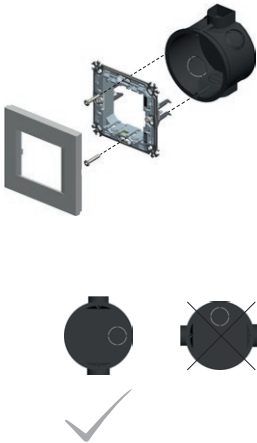

DE12,13

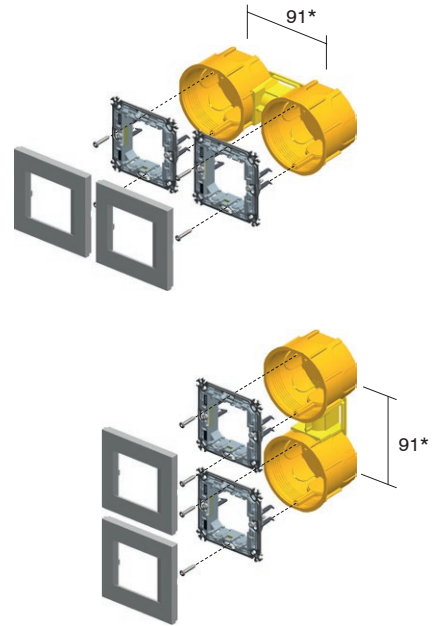
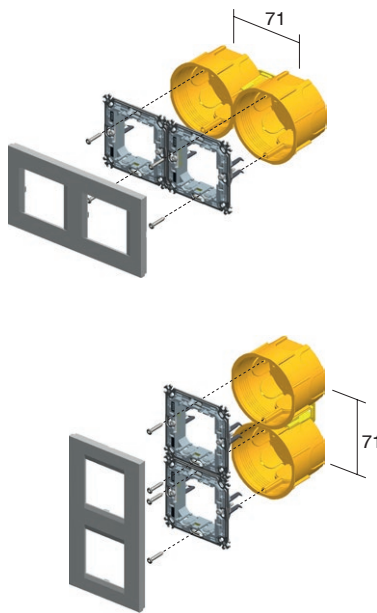
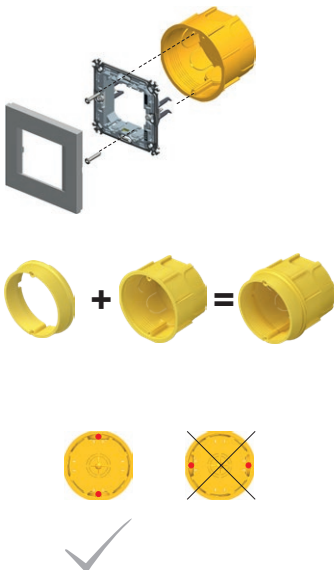

\* für Rahmen PURE beträgt der Abstand zwischen Dosen  
100 mm  
\* for PURE cover plates the minimum distance between  
boxes is 100mm

R O U N D     B O X E S



DE10,11



DE12,13



NM20



NM24



DE10,11



DE12,13



NM10



DE10,11



DE12,13



NM23



71

2xDE10,11 + 2xDE31



2xNM20



2xDE12,13 + 1xDE32



2xNM24



2xDE10,11    2xDE12,13 + 1xDE32

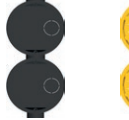

2xNM20

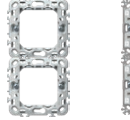

2xNM24

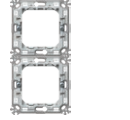

3xDE10,11 + 3xDE31



3xNM20



3xDE12,13 + 2xDE32



3xNM24



3xDE10,11    3xDE12,13 + 2xDE32

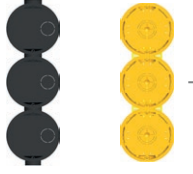

3xNM20



3xNM24



4xDE10,11 + 4xDE31



4xNM20



4xDE12,13 + 3xDE32



4xNM24



4xDE10,11    4xDE12,13 + 3xDE32

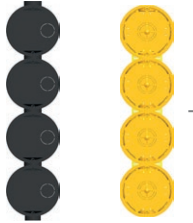

4xNM20



4xNM24

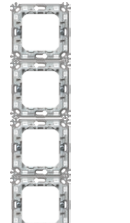

N  
E  
S  
D  
O



HE10

**RUNDDOSE HOHLWAND SM68x40**

- Durchmesser Ø60 mm, Tiefe 40mm
- Einbauloch Ø68
- 850°C, 400V~
- entspricht IEC 60670-1
- Montage mit Krallen
- ohne Halogen

*ROUND BOX HOLLOW WALL SM68x40*

- Ø60, depth 40mm
- cutting hole Ø68
- 850°C, 400V~
- in accordance with IEC 60670-1
- mounting with claws
- halogen free

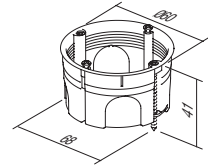

HE11

**RUNDDOSE HOHLWAND SM68x55**

- Durchmesser Ø60 mm, Tiefe 55mm
- Einbauloch Ø68
- 850°C, 400V~
- entspricht IEC 60670-1
- Montage mit Krallen
- ohne Halogen

*ROUND BOX HOLLOW WALL SM68x55*

- Ø60, depth 55mm
- cutting hole Ø68
- 850°C, 400V~
- in accordance with IEC 60670-1
- mounting with claws
- halogen free

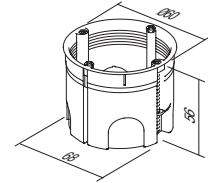

BE10

**RUNDDOSE BETONWAND**

- Durchmesser Ø60 mm, Tiefe 49mm
- 650°C, 500V~
- entspricht IEC 60670-1
- ohne Halogen

*ROUND BOX CONCRETE*

- Ø60mm, depth 49mm
- 650°C, 500V~
- in accordance with IEC 60670-1
- halogen free

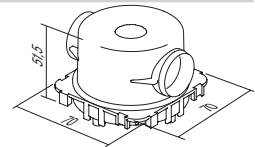

BE11

**RUNDDOSE BETONWAND TIEF**

- Durchmesser Ø60 mm, Tiefe 58 mm
- 650°C, 500V~
- entspricht IEC 60670-1
- ohne Halogen

*ROUND BOX CONCRETE DEEP*

- Ø60mm, depth 58mm
- 650°C, 500V~
- in accordance with IEC 60670-1
- halogen free

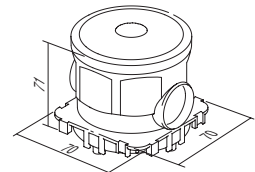

BE20

**GEGENLAGER FÜR RUNDDOSE BETONWAND**

- zur Abstützung der Dose durch ein Distanzprofil BM82 in die Gegenwand
- entspricht IEC 60670-1
- ohne Halogen

*COUNTER BOX SUPPORT CONCRETE*

- to support concrete boxes with discance profile BM82 for extreme loads
- in accordance with IEC 60670-1
- halogen free

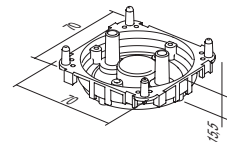

BE21

**ROHREINFÜHRUNG 16 FÜR RUNDDOSE BETONWAND**

- für Rohrfixierung auch bei größeren Belastungen
- entspricht IEC 60670-1
- ohne Halogen

*PIPE STOPPER CONCRETE BOX 16*

- for firming installation pipe to box
- in accordance with IEC 60670-1
- halogen free

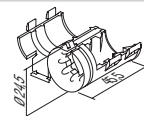



R O U N D B O X E S

Hohlwand/ hollow walls



Betonwand/ concrete



Montageanleitung/  
assembly instructions

Abstand zwischen Dosen /  
distance between boxes: 71mm

Abstand zwischen Dosen /  
distance between boxes: 91mm

HE10,11

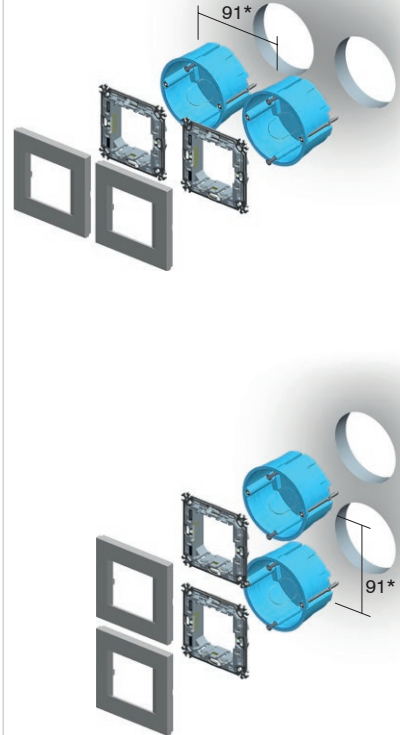
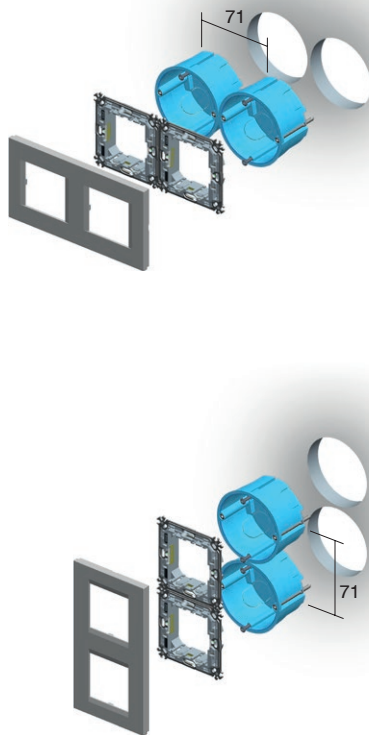
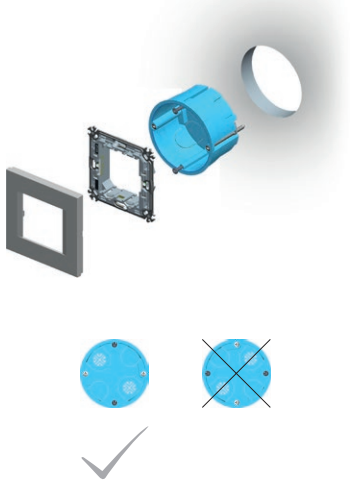

BE10

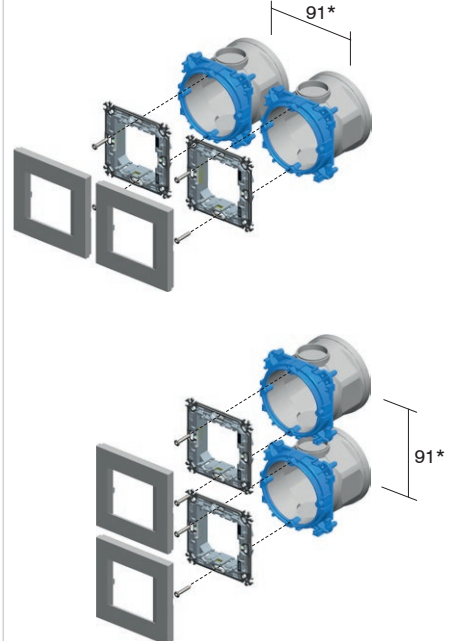
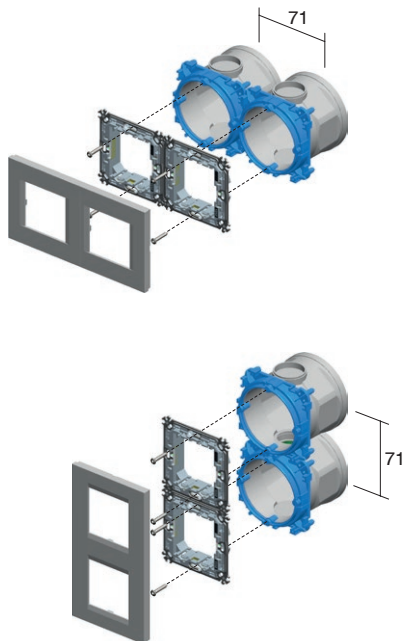
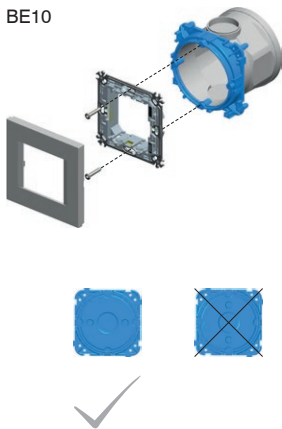

\* für Rahmen PURE beträgt der Abstand zwischen Dosen 100 mm  
\* for PURE cover plates the minimum distance between boxes is 100mm

N  
E  
S  
D  
O  
S



HE10,11



BE10,11



NM21



NM25



2M

HE10,11



BE10,11



NM11



1/2M

2xHE10,11



2xBE10,11



2xNM21



2xNM25



2x2M

HE10,11



BE10,11



NM32



2/3M

2xHE10,11



2xBE10,11



2xNM21



2xNM25



3xHE10,11

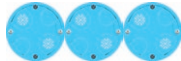

3xBE10,11



3xNM21



3xNM25

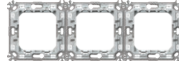

3x2M

3xHE10,11



3xBE10,11



3xNM21



3xNM25

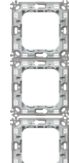

4xHE10,11



4xBE10,11



4xNM21



4xNM25



4x2M

4xHE10,11



4xBE10,11



4xNM21



4xNM25



R O U N D     B O X E S



Montageanleitung/  
assembly instructions

1

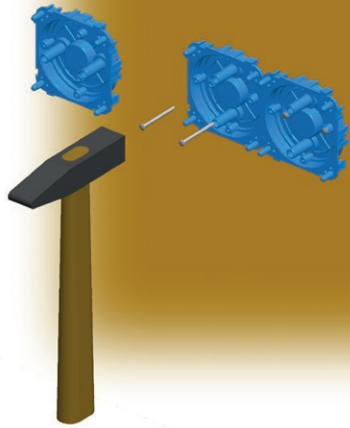

2

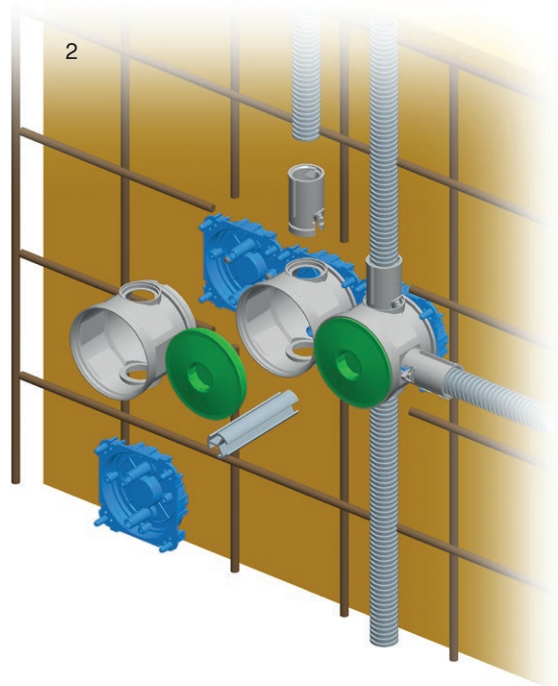

3

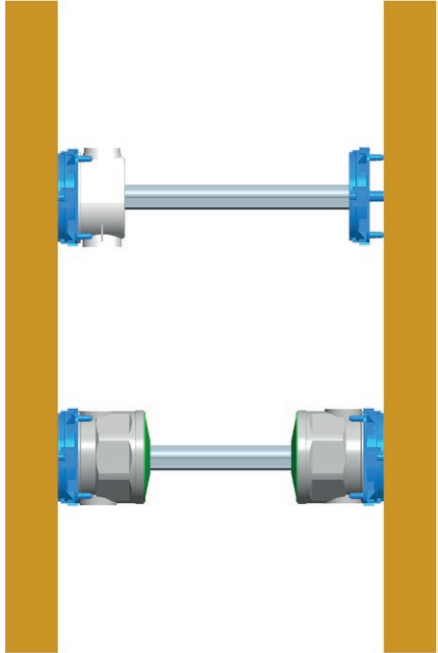

4

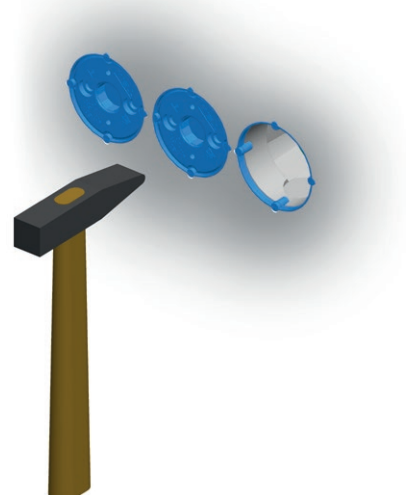



DM30



HM30



BM30

Typ type	Bezeichnung description	Größe size
DM30	RECHTECKDOSE ZIEGELWAND RECTANGULAR BOX BRICK	PM3
HM30	RECHTECKDOSE HOHLWAND RECTANGULAR BOX HOLLOW WALL	VM3
BM30	RECHTECKDOSE BETONWAND RECTANGULAR BOX CONCRETE	BM3
·	·	·
·	·	·

RECHTECKDOSE ZIEGELWAND PM3



DM30

- Breite 3M, Tiefe 49mm
- 650°C, 400V<sup>~</sup>
- entspricht IEC 60670-1
- ohne Halogen

RECTANGULAR BOX BRICK PM3

- size 3M, depth 49mm
- 650°C, 400V<sup>~</sup>
- in accordance with IEC 60670-1
- halogen free

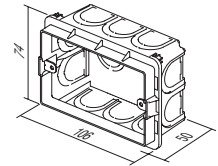

RECHTECKDOSE ZIEGELWAND PM3-65



DM31

- Breite 3M, Tiefe 65mm
- 650°C, 400V<sup>~</sup>
- entspricht IEC 60670-1
- ohne Halogen

RECTANGULAR BOX BRICK PM3-65

- size 3M, depth 65mm
- 650°C, 400V<sup>~</sup>
- in accordance with IEC 60670-1
- halogen free

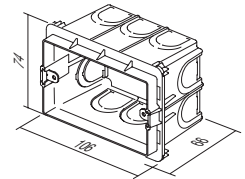

RECHTECKDOSE ZIEGELWAND PM4



DM40

- Breite 4M, Tiefe 49mm
- 650°C, 400V<sup>~</sup>
- entspricht IEC 60670-1
- ohne Halogen

RECTANGULAR BOX BRICK PM4

- size 4M, depth 49mm
- 650°C, 400V<sup>~</sup>
- in accordance with IEC 60670-1
- halogen free

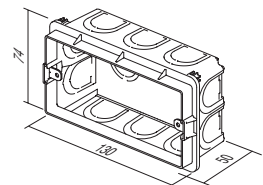

RECHTECKDOSE ZIEGELWAND PM4-65



DM41

- Breite 4M, Tiefe 65 mm
- 650°C, 400V<sup>~</sup>
- entspricht IEC 60670-1
- ohne Halogen

RECTANGULAR BOX BRICK PM4-65

- size 4M, depth 65mm
- 650°C, 400V<sup>~</sup>
- in accordance with IEC 60670-1
- halogen free

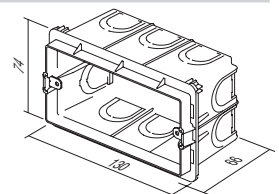

R E C T A N G U L A R   B O X E S

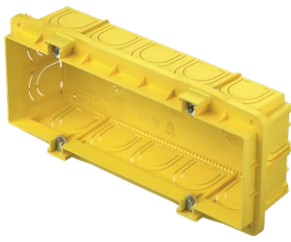

DM70

RECHTECKDOSE ZIEGELWAND PM7

- Breite 7M, Tiefe 49mm
- 650°C, 400V $\sim$
- entspricht IEC 60670-1
- ohne Halogen

RECTANGULAR BOX BRICK PM7

- size 7M, depth 49mm
- 650°C, 400V $\sim$
- in accordance with IEC 60670-1
- halogen free

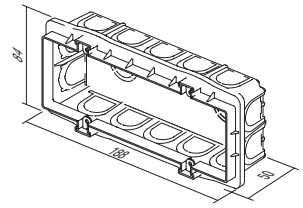

DM71

RECHTECKDOSE ZIEGELWAND PM7-65

- Breite 7M, Tiefe 65mm
- 650°C, 400V $\sim$
- entspricht IEC 60670-1
- ohne Halogen

RECTANGULAR BOX BRICK PM7-65

- size 7M, depth 65mm
- 650°C, 400V $\sim$
- in accordance with IEC 60670-1
- halogen free

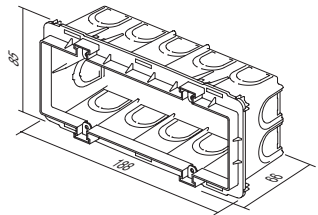

DM72

RECHTECKDOSE ZIEGELWAND PM72-65

- Breite 2x7M, Tiefe 64mm
- 650°C, 400V $\sim$
- entspricht IEC 60670-1
- ohne Halogen

RECTANGULAR BOX BRICK PM72-65

- size 2x7M, depth 64mm
- 650°C, 400V $\sim$
- in accordance with IEC 60670-1
- halogen free

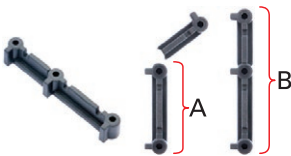
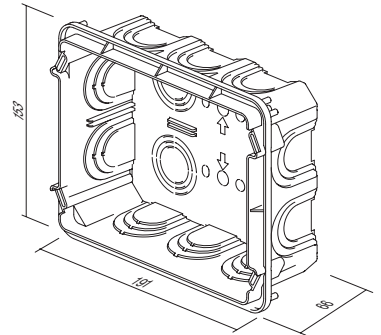

DM80

ABSTANDHALTER FÜR RECHTECKDOSEN PM

- ermöglicht Vertikal- (A) und Horizontalmontage (B) von mehreren Rechteckdosen PM3, PM4 und PM7 auf eine feste Distanz
- Geeignet für Rahmen LINE und SOFT (nicht geeignet für Rahmen PURE)

DISTANCE PIECE FOR BOX PM

- for vertical (A) and horizontal (B) fitting of boxes PM3, PM4 and PM7
- suitable for Line and Soft decorative cover plates (not for PURE)

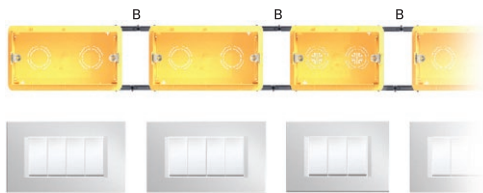
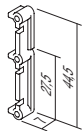



DM33

**FEDERDECKEL PM3**

- Federdeckel für Rechteckdosen PM3
- entspricht IEC 60670-1
- ohne Halogen
- zum Schutz beim Verputzen

*BOX COVER PROTECTIVE PM3*

- protective cover for box PM3
- in accordance with IEC 60670-1
- halogen free
- box protection during plastering

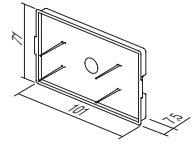

DM34

**ABDECKUNG DEKORATIV PM3**

- dekorative Abdeckung für Rechteckdosen 3M
- inkl. Schrauben
- entspricht IEC 60670-1
- ohne Halogen

*BOX COVER DECORATIVE PM3*

- decorative cover for boxes 3M
- screws are included
- in accordance with IEC 60670-1
- halogen free

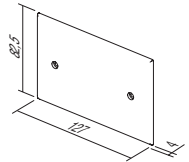

DM43

**FEDERDECKEL PM4**

- Federdeckel für Rechteckdosen PM4
- entspricht IEC 60670-1
- ohne Halogen
- zum Schutz beim Verputzen

*BOX COVER PROTECTIVE PM4*

- protective cover for box PM4
- in accordance with IEC 60670-1
- halogen free
- box protection during plastering

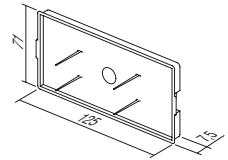

DM44

**ABDECKUNG DEKORATIV PM4**

- dekorative Abdeckung für Rechteckdosen 4M
- inkl. Schrauben
- entspricht IEC 60670-1
- ohne Halogen

*BOX COVER DECORATIVE PM4*

- decorative cover for boxes 4M
- screws are included
- in accordance with IEC 60670-1
- halogen free

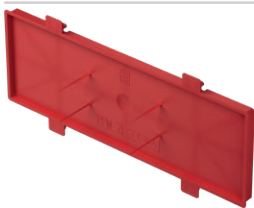
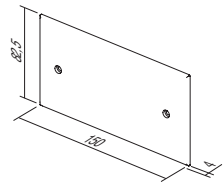

DM73

**FEDERDECKEL PM7**

- Federdeckel für Rechteckdosen PM7
- entspricht IEC 60670-1
- ohne Halogen
- zum Schutz beim Verputzen

*BOX COVER PROTECTIVE PM7*

- protective cover for box PM7
- in accordance with IEC 60670-1
- halogen free
- box protection during plastering

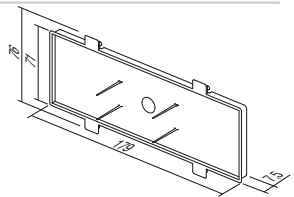

DM74

**ABDECKUNG DEKORATIV PM7**

- dekorative Abdeckung für Rechteckdosen 7M
- inkl. Schrauben
- entspricht IEC 60670-1
- ohne Halogen

*BOX COVER DECORATIVE PM7*

- decorative cover for boxes 7M
- screws are included
- in accordance with IEC 60670-1
- halogen free

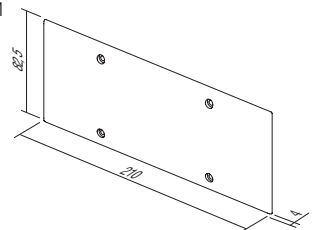

## R E C T A N G U L A R   B O X E S



DM75

## ABDECKUNG DEKORATIV PM72

- dekorative Abdeckung für Rechteckdosen 2x7M
- inkl. Schrauben
- entspricht IEC 60670-1

*BOX COVER DECORATIVE PM72*

- decorative cover for boxes 2x7M
- screws are included
- in accordance with IEC 60670-1

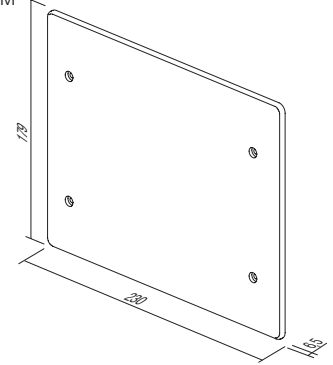



HM30

RECHTECKDOSE HOHLWAND VM3

- Breite 3M, Tiefe 49mm
- Einbauloch 2xØ68/45mm
- 850°C, 400V $\sim$
- entspricht IEC 60670-1
- ohne Halogen

RECTANGULAR BOX HOLLOW WALL VM3

- size 3M, depth 49mm
- cutting hole 2xØ68/45mm
- 850°C, 400V $\sim$
- in accordance with IEC 60670-1
- halogen free

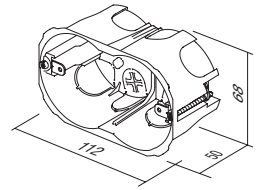

HM40

RECHTECKDOSE HOHLWAND VM4

- Breite 4M, Tiefe 49mm
- Einbauloch 2xØ68/70mm
- 850°C, 400V $\sim$
- entspricht IEC 60670-1
- ohne Halogen

RECTANGULAR BOX HOLLOW WALL VM4

- size 4M, depth 49mm
- cutting hole 2xØ68/70mm
- 850°C, 400V $\sim$
- in accordance with IEC 60670-1
- halogen free

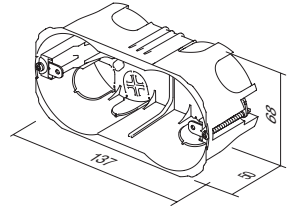

HM70

RECHTECKDOSE HOHLWAND VM7

- Breite 7M, Tiefe 49mm
- Einbauloch 2xØ68/120 mm
- 850°C, 400V $\sim$
- entspricht IEC 60670-1
- ohne Halogen

RECTANGULAR BOX HOLLOW WALL VM7

- size 7M, depth 49mm
- cutting hole 2xØ68/120mm
- 850°C, 400V $\sim$
- in accordance with IEC 60670-1
- halogen free

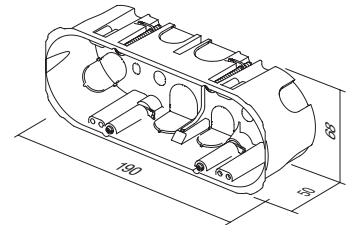

HM72

RECHTECKDOSE HOHLWAND VM72

- Breite 2x7M, Tiefe 63mm
- 850°C, 400V $\sim$
- entspricht IEC 60670-1
- ohne Halogen

RECTANGULAR BOX HOLLOW WALL VM72

- size 2x7M, depth 63mm
- 850°C, 400V $\sim$
- in accordance with IEC 60670-1
- halogen free

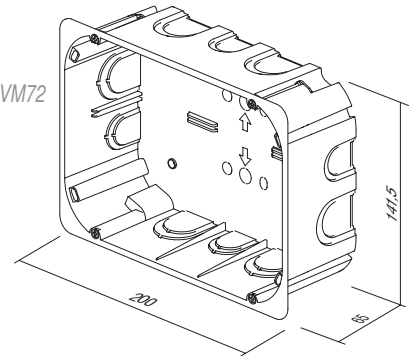



## R E C T A N G U L A R   B O X E S



BM30

## RECHTECKDOSE BETONWAND BM3

- Breite 3M, Tiefe 60 mm
- 650°C, 400V<sup>~</sup>
- entspricht IEC 60670-1
- ohne Halogen

## RECTANGULAR BOX CONCRETE BM3

- size 3M, depth 60mm
- 650°C, 400V<sup>~</sup>
- in accordance with IEC 60670-1
- halogen free

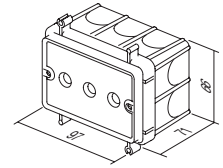

BM40

## RECHTECKDOSE BETONWAND BM4

- Breite 4M, Tiefe 60 mm
- 650°C, 400V<sup>~</sup>
- entspricht IEC 60670-1
- ohne Halogen

## RECTANGULAR BOX CONCRETE BM4

- size 4M, depth 60mm
- 650°C, 400V<sup>~</sup>
- in accordance with IEC 60670-1
- halogen free

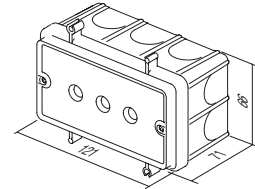

BM70

## RECHTECKDOSE BETONWAND BM7

- Breite 7M, Tiefe 60 mm
- 650°C, 400V<sup>~</sup>
- entspricht IEC 60670-1
- ohne Halogen

## RECTANGULAR BOX CONCRETE BM7

- size 7M, depth 60mm
- 650°C, 400V<sup>~</sup>
- in accordance with IEC 60670-1
- halogen free

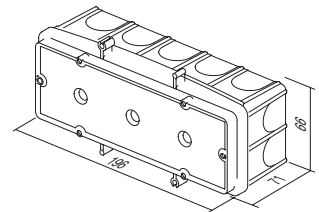

BM80

## BEFESTIGUNGSELEMENT FÜR DOSEN BM

- für schnelle Befestigung von Rechteckdosen BM auf die Bewehrung
- geeignet für Stäbe bis Durchmesser Ø8 mm

## FIXING COMBI-CLIP BM

- for fast fixation of BM rectangular boxes on reinforcing bar
- suitable for bar diameter up to Ø8mm

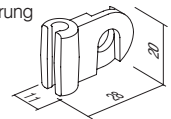

BM82

## DISTANZPROFIL FÜR DOSEN

- zur Abstützung von Rechteckdosen BM zusammen mit deren Träger in die Gegenwand
- Länge l=1m, Durchmesser Ø20 mm

## DISTANCE PROFIL FOR BOXES BM

- to support boxes BM with counter box support on opposite wall
- length l=1m, diameter Ø20mm

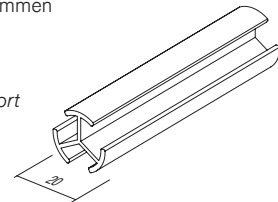

# R E C H T E C K D O S E N

Ziegelwand / brick

Hohlwand / hollow walls

Betonwand / concrete

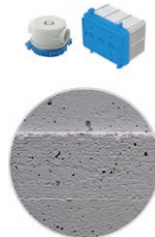
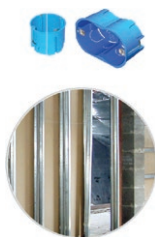
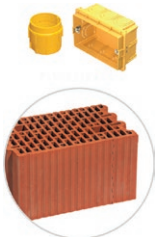



D O S E N

DM30   **NM30**

HM30  ——— 

BM30 

**3M**

DM40   **NM40**

HM40  ——— 

BM40 

**4M**

DM70   **NM70**

HM70  ——— 

BM70 

**7M**

DM72   **NM72**

HM72 

**2x7M**

DM30   **NM32**

HM30  ——— 

BM30 

**2/3M**

R E C T A N G U L A R   B O X E S

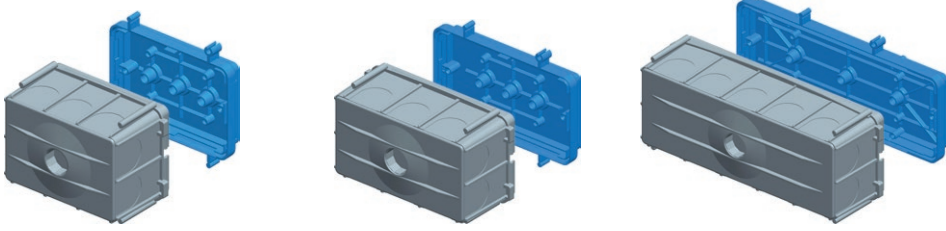

Montageanleitung/  
assembly instructions

1

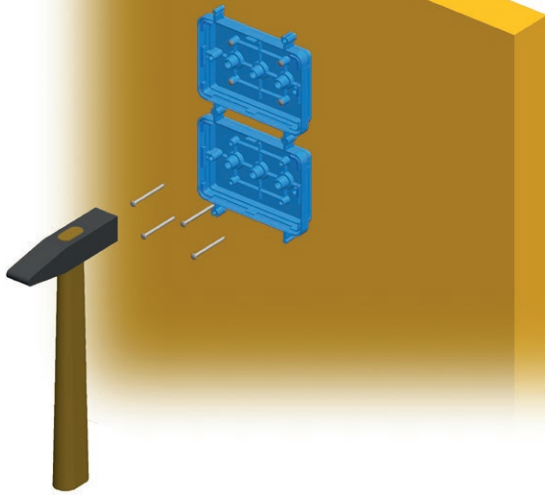

2

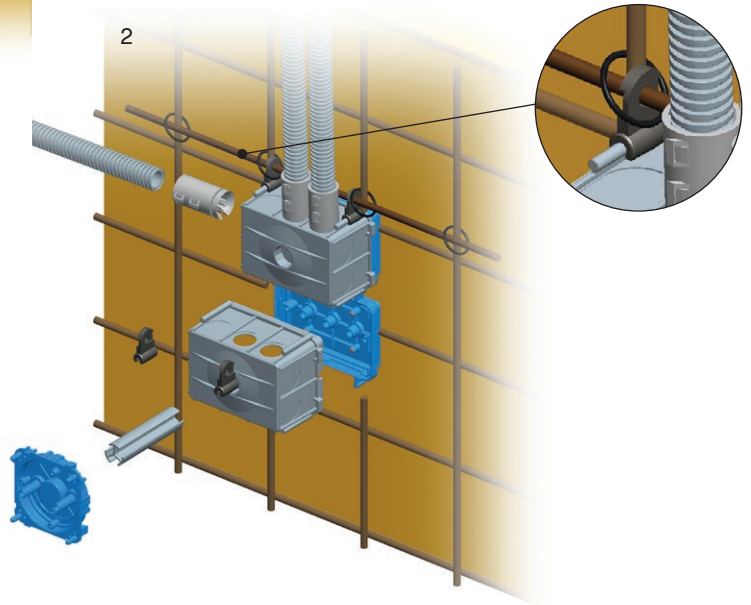

3

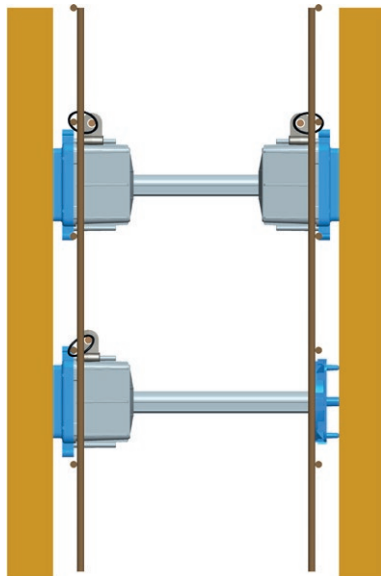

4

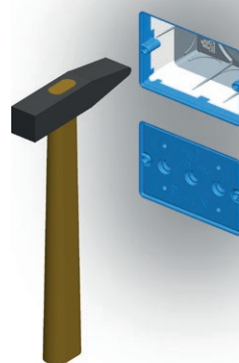



DW10

**ABZWEIGDOSE RUND ZIEGELWAND DSM78**

- Durchmesser  $\varnothing 78$  mm, Tiefe 40mm
- 650°C, 500V $\sim$
- entspricht IEC 60670-1 und IEC 60670-22
- ohne Halogen

*CONNECTION ROUND BOX BRICK DSM78*

- $\varnothing 78$ , depth 40mm
- 650°C, 500V $\sim$
- in accordance with IEC 60670-1 and IEC 60670-22
- halogen free

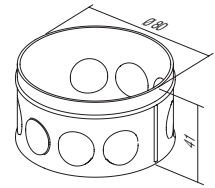

HW10

**ABZWEIGDOSE RUND HOHLWAND SM78x45**

- Durchmesser  $\varnothing 78$  mm, Tiefe 45 mm
- Einbauloch  $\varnothing 80$
- 850°C, 400V $\sim$
- entspricht IEC 60670-1 und IEC 60670-22
- Montage mit Krallen
- ohne Halogen

*CONNECTION ROUND BOX HOLLOW WALL SM78x45*

- $\varnothing 78$ , depth 45mm
- cutting hole  $\varnothing 80$
- 850°C, 400V $\sim$
- in accordance with IEC 60670-1 and IEC 60670-22
- mounting with claws
- halogen free

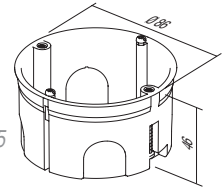

DE23

**ABDECKUNG DEKORATIV SM78**

- dekorative Abdeckung für Dosen  $\varnothing 78$
- entspricht IEC 60670-1 und IEC 60670-22
- ohne Halogen

*BOX COVER DECORATIVE SM78*

- decorative cover for boxes  $\varnothing 78$
- in accordance with IEC 60670-1 and IEC 60670-22
- halogen free

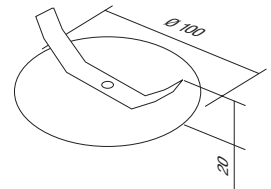

DE24

**FEDERDECKEL 78**

- Federdeckel für Dosen  $\varnothing 78$
- entspricht IEC 60670-1 und IEC 60670-22
- ohne Halogen

*BOX COVER PROTECTIVE 78*

- protective cover for box  $\varnothing 78$
- in accordance with IEC 60670-1 and IEC 60670-22
- halogen free

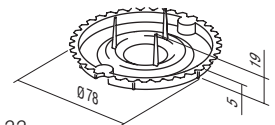

HW20

**ABZWEIGKASTEN ZIEGELWAND SM105x105**

- 105x105 mm, Tiefe 50 mm
- Einbauloch gemäß beigelegter Lehre
- 850°C, 400V $\sim$
- entspricht IEC 60670-1 und IEC 60670-22
- Montage mit Krallen
- ohne Halogen

*CONNECTION SQUARE BOX BRICK SM105x105*

- size 105x105mm, depth 50mm
- cutting hole according to attached template
- 850°C, 400V $\sim$
- in accordance with IEC 60670-1 and IEC 60670-22
- mounting with claws
- halogen free

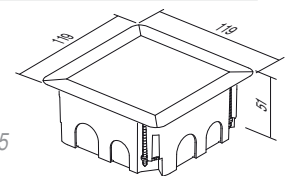

J U N C T I O N   B O X E S

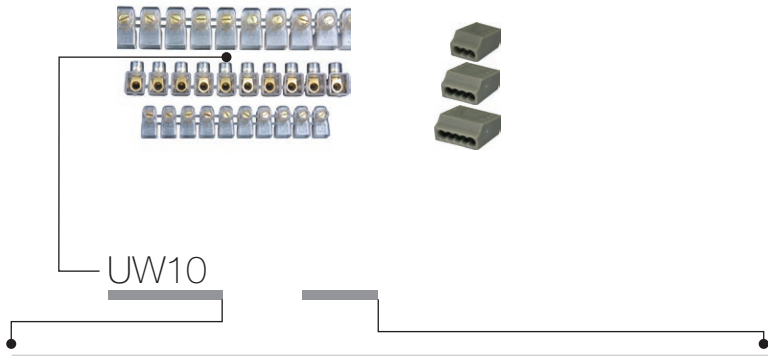

Typ type	Bezeichnung description	Technische Daten technical data	Größe size	Farbe colour
UW10	DOSENKLEMMLEISTEN GESCHLOSSEN 1 ROW TERMINAL BLOCKS	2x2.5mm <sup>2</sup>	10P	<input checked="" type="checkbox"/> TS transparent transparent
UW11	DOSENKLEMMLEISTEN GESCHLOSSEN 1 ROW TERMINAL BLOCKS	2x4mm <sup>2</sup>	10P	<input checked="" type="checkbox"/> CO farbig colour
UW12	DOSENKLEMMLEISTEN GESCHLOSSEN 1 ROW TERMINAL BLOCKS	2x6mm <sup>2</sup>	10P	<input type="checkbox"/> WH weiß white
⋮	⋮	⋮	⋮	<input type="checkbox"/> GY grau grey

DOSENKLEMMLEISTEN GESCHLOSSEN



- 450V~; 2x2,5 mm<sup>2</sup> ÷ 2x6 mm<sup>2</sup>
- Thermoplast PC, transparent
- Klemmen in Leiste: 10

1 ROW TERMINAL BLOCKS CLOSED

- 450V~; 2x2,5mm<sup>2</sup> ÷ 2x6mm<sup>2</sup>
- thermoplast PC, transparent
- number of poles: 10

UW10TS	(NS12)	2x2.5mm <sup>2</sup>	10P
UW11TS	(NS12)	2x4mm <sup>2</sup>	10P
UW12TS	(NS12)	2x6mm <sup>2</sup>	10P

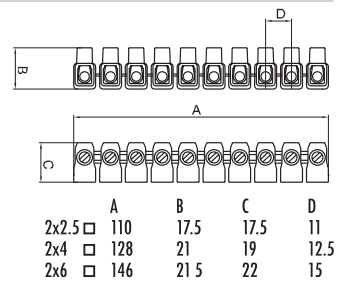

DOSENKLEMMLEISTEN

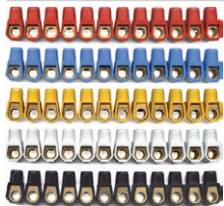

- 450V~; 2x2,5 mm<sup>2</sup> ÷ 2x6 mm<sup>2</sup>
- Thermoplast PA
- in verschiedenen Farben erhältlich
- Klemmen in Leiste: 12

1 ROW TERMINAL BLOCKS

- 450V~; 2x2,5mm<sup>2</sup> ÷ 2x6mm<sup>2</sup>
- thermoplast PA
- available in different colours
- number of poles: 12

UW15CO	(NS12)	2x2.5mm <sup>2</sup>	12P
UW16CO	(NS12)	2x4mm <sup>2</sup>	12P
UW17CO	(NS12)	2x6mm <sup>2</sup>	12P

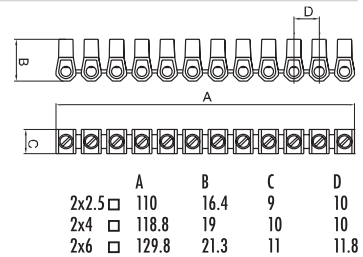

LÜSTER-KLEMMLEISTEN PP

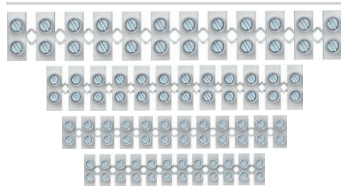

- 450 V~; 1 mm<sup>2</sup> ÷ 16 mm<sup>2</sup>
- Thermoplast Polypropylen PP, weiß
- für Temperaturen bis zu 80°C
- Klemmen in Leiste: 12

2 ROW TERMINAL BLOCKS PP

- 450V~; 1mm<sup>2</sup> ÷ 16mm<sup>2</sup>
- thermoplast polypropylene PP, white
- for temperatures up to 80°C
- number of poles: 12

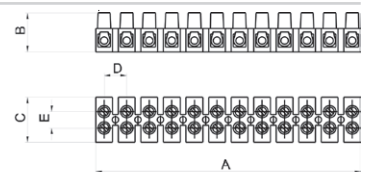

					A	B	C	D	E
UW29WHPP	1.0-4.0mm <sup>2</sup>	24 A	450 V		94,9	13	16,6	8,1	6,4
UW30WHPP	1.5-6.0mm <sup>2</sup>	32 A	450 V		116,5	14,9	18,9	10	7,3
UW31WHPP	2.5-10mm <sup>2</sup>	41 A	450 V		133,8	17,3	23,4	11,5	10
UW32WHPP	4-16mm <sup>2</sup>	76 A	450 V		174,5	20,7	25	15	11

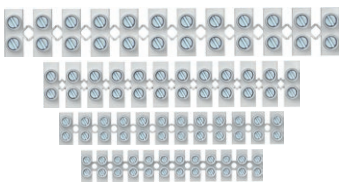

## LÜSTER-KLEMMLEISTEN PA

- 450 V $\sim$ ; 1 mm<sup>2</sup> ÷ 16 mm<sup>2</sup>
- Thermoplast Polyamid PA, weiß
- für Temperaturen bis zu 110°C
- Klemmen in Leiste: 12

## 2 ROW TERMINAL BLOCKS PA

- 450V $\sim$ ; 1mm<sup>2</sup> ÷ 16mm<sup>2</sup>
- thermoplast polyamide PA, white
- for temperatures up to 110°C
- number of poles: 12

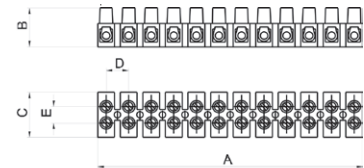

					A	B	C	D	E
UW25WHPA	1.0-4.0mm <sup>2</sup>	24 A	450 V		93,6	13,4	16,2	8	6,4
UW26WHPA	1.5-6.0mm <sup>2</sup>	32 A	450 V		117	15	18,6	10	7,3
UW27WHPA	2.5-10mm <sup>2</sup>	41 A	450 V		132,8	17,3	22,2	11,5	10
UW28WHPA	4-16mm <sup>2</sup>	76 A	450 V		173,9	20,8	25,2	15	11

## STECKKLEMMEN



- 24A 450V $\sim$ , Thermoplast PA, grau
- Klemmen in Leiste: 3÷8
- Steckklemmen 0,5÷1,5 mm<sup>2</sup>, für harte Drähte
- entspricht EN 60998-1

## PLUG-IN WIRE CONNECTORS

- 24A 450V $\sim$ , thermoplast PA, grey
- number of poles: 3÷8
- plug-in contacts 0.5÷1.5mm<sup>2</sup>, for rigide wires
- in accordance with EN 60998-1

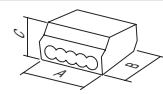

UW40GY	PC153	1.5mm <sup>2</sup>	3P	3P	A 12	B 18	C 9
UW41GY	PC155	1.5mm <sup>2</sup>	5P	5P	17	18	9
UW42GY	PC158	1.5mm <sup>2</sup>	8P	8P	26	18	9

## STECKKLEMMEN



- 24A 450V $\sim$ , Thermoplast PA, grau
- Klemmen in Leiste: 3÷5
- Steckklemmen 1,5÷2,5 mm<sup>2</sup>, für harte Drähte
- entspricht EN 60998-1

## PLUG-IN WIRE CONNECTORS

- 24A 450V $\sim$ , thermoplast PA, grey
- number of poles: 3÷5
- plug-in contacts 1.5÷2.5mm<sup>2</sup>, for rigide wires
- in accordance with EN 60998-1

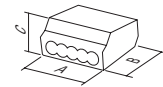

UW45GY	PC253	2.5mm <sup>2</sup>	3P	3P	A 14	B 19	C 9
UW46GY	PC254	2.5mm <sup>2</sup>	4P	4P	17	19	9
UW47GY	PC255	2.5mm <sup>2</sup>	5P	5P	21	19	9

## STECKKLEMMEN



- 24A 450V $\sim$ , Thermoplast PA, grau
- Klemmen in Leiste: 2 (harter Draht) + 1 (weicher Draht)
- Steckklemmen 1,5÷2,5 mm<sup>2</sup>
- entspricht EN 60998-1

## PLUG-IN WIRE CONNECTOR

- 24A 450V $\sim$ , thermoplast PA, grey
- number of poles: 2 (rigide wire)+1 (soft wire)
- plug-in contacts 1.5÷2.5mm<sup>2</sup>
- in accordance with EN 60998-1

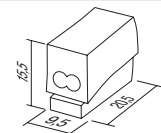

UW50WH	PC302	2.5mm <sup>2</sup>	2/1P				
--------	-------	--------------------	------	--	--	--	--

TEM

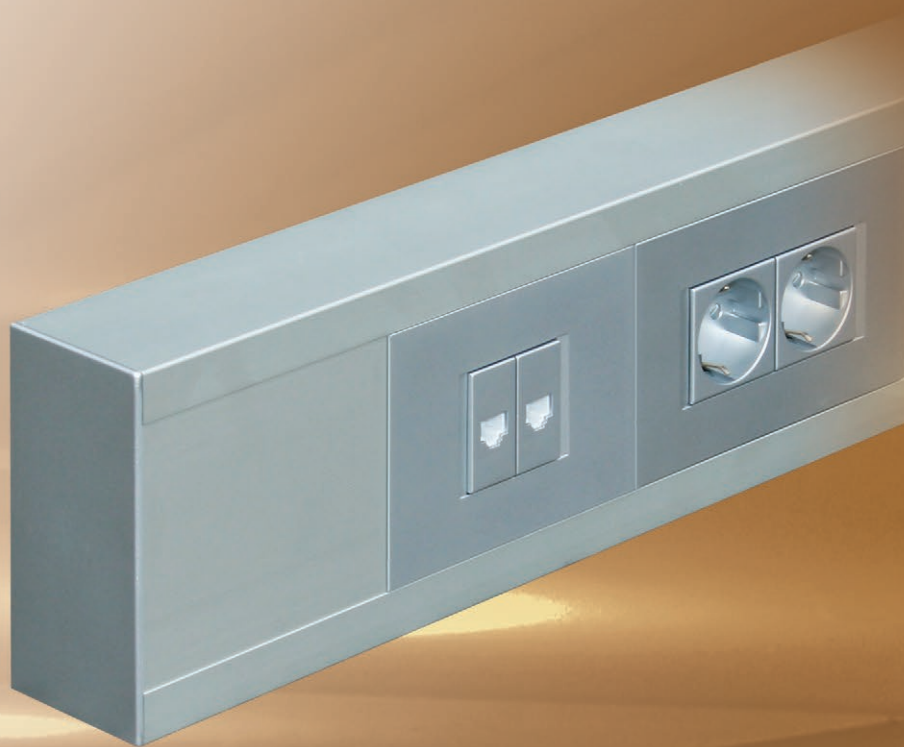





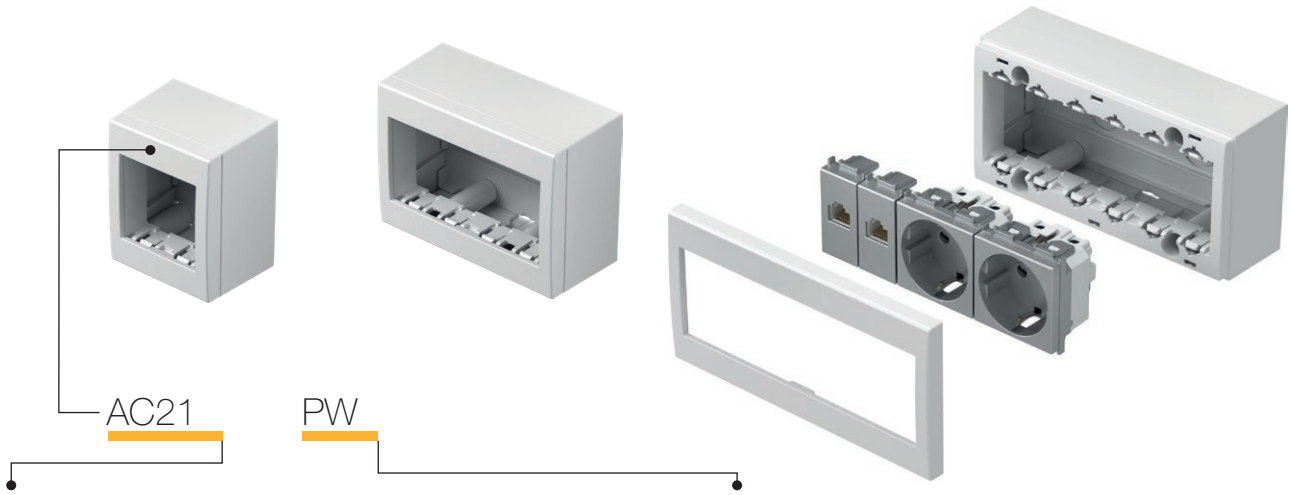

<p>AUFPUTZGEHÄUSE CUBO IP20 AC <i>BOXES CUBO IP20 AC</i></p>		162
<p>AUFPUTZGEHÄUSE CUBO IP55 AQ <i>BOXES CUBO IP55 AQ</i></p>		163
<p>BRÜSTUNGSKANÄLE ALU MA <i>TRUNKING SYSTEM ALUMINIUM MA</i></p>		165
<p>BODENDOSEN MT <i>FLOOR BOXES MT</i></p>		171
<p>VERTEILERKASTEN MO <i>DISTRIBUTION BOARDS MO</i></p>		173

# A U F P U T Z G E H Ä U S E C U B O I P 2 0 A C



Typ type	Bezeichnung description	Technische Daten technical data	Größe size	Farbe colour
AC11	AUFPUTZGEHÄUSE NO CUBO MIT BODEN SURFACE MOUNT BOX WITH BACK SIDE COVER	IP20	1M	<input type="checkbox"/> PW weiß-glanz polar white <input type="checkbox"/> ES silber-matt elox silver <input type="checkbox"/> IW beige-glanz ivory white
AC21	AUFPUTZGEHÄUSE NO CUBO MIT BODEN SURFACE MOUNT BOX WITH BACK SIDE COVER	IP20	2M	<input type="checkbox"/> PW weiß-glanz polar white <input type="checkbox"/> ES silber-matt elox silver <input type="checkbox"/> IW beige-glanz ivory white
AC41	AUFPUTZGEHÄUSE NO CUBO MIT BODEN SURFACE MOUNT BOX WITH BACK SIDE COVER	IP20	4M	<input type="checkbox"/> PW weiß-glanz polar white <input type="checkbox"/> ES silber-matt elox silver <input type="checkbox"/> IW beige-glanz ivory white

## AUFPUTZGEHÄUSE NO CUBO MIT BODEN IP20 1M



<input type="checkbox"/> AC11PW <input type="checkbox"/> AC11ES <input type="checkbox"/> AC11IW	<ul style="list-style-type: none"> <li>- Aufputzgehäuse IP20 1M</li> <li>- Aufputzbefestigung der Elemente</li> <li>- geeignet für Schalter SM</li> <li>- entspricht EN 60669-1</li> </ul> <p><i>BOX NO CUBO WITH BACK SIDE COVER IP20 1M</i></p> <ul style="list-style-type: none"> <li>- box IP20 1M</li> <li>- for surface mounting of elements</li> <li>- suitable to SM switches</li> <li>- in accordance with EN 60669-1</li> </ul>
---	---



## AUFPUTZGEHÄUSE NO CUBO MIT BODEN IP20 2M



<input type="checkbox"/> AC21PW <input type="checkbox"/> AC21ES <input type="checkbox"/> AC21IW	<ul style="list-style-type: none"> <li>- Aufputzgehäuse IP20 2M</li> <li>- Aufputzbefestigung der Elemente</li> <li>- entspricht EN 60669-1, EN60884-1</li> </ul> <p><i>BOX NO CUBO WITH BACK SIDE COVER IP20 2M</i></p> <ul style="list-style-type: none"> <li>- box IP20 2M</li> <li>- for surface mounting of elements</li> <li>- in accordance with EN 60669-1, EN60884-1</li> </ul>
---	--



## AUFPUTZGEHÄUSE NO CUBO MIT BODEN IP20 4M



<input type="checkbox"/> AC41PW <input type="checkbox"/> AC41ES <input type="checkbox"/> AC41IW	<ul style="list-style-type: none"> <li>- Aufputzgehäuse IP20 4M</li> <li>- Aufputzbefestigung der Elemente</li> <li>- entspricht EN 60669-1, EN60884-1</li> </ul> <p><i>BOX NO CUBO WITH BACK SIDE COVER IP20 4M</i></p> <ul style="list-style-type: none"> <li>- box IP20 4M</li> <li>- for surface mounting of elements</li> <li>- in accordance with EN 60669-1, EN60884-1</li> </ul>
---	--



## AUFPUTZGEHÄUSE NO CUBO MIT BODEN IP20 6M



<input type="checkbox"/> AC61PW <input type="checkbox"/> AC61ES <input type="checkbox"/> AC61IW	<ul style="list-style-type: none"> <li>- Aufputzgehäuse IP20 6M</li> <li>- Aufputzbefestigung der Elemente</li> <li>- entspricht EN 60669-1, EN60884-1</li> </ul> <p><i>BOX NO CUBO WITH BACK SIDE COVER IP20 6M</i></p> <ul style="list-style-type: none"> <li>- box IP20 6M</li> <li>- for surface mounting of elements</li> <li>- in accordance with EN 60669-1, EN60884-1</li> </ul>
---	--



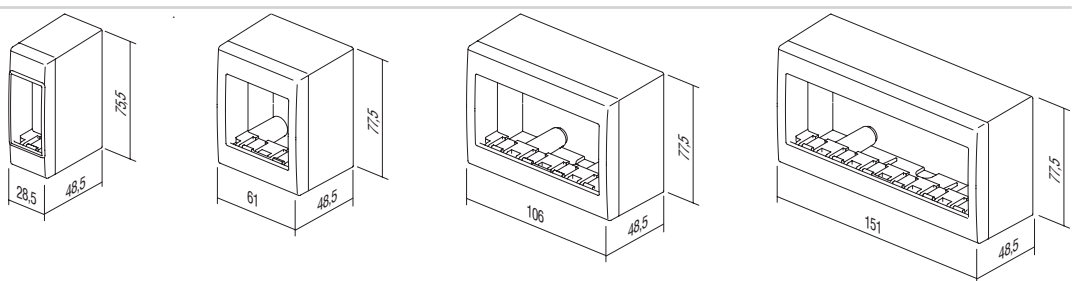

## B O X E S C U B O I P 5 5 A Q

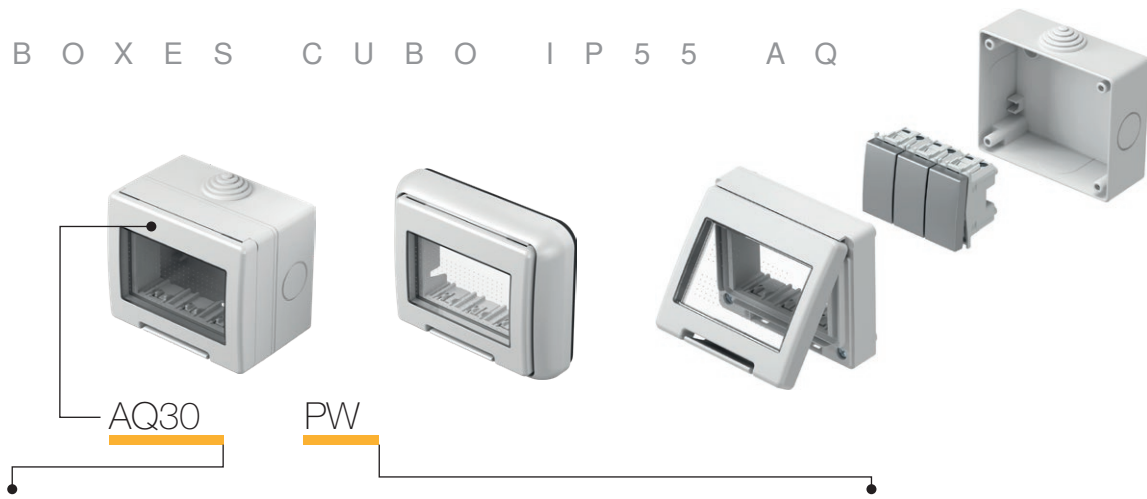

Typ type	Bezeichnung description	Technische Daten technical data	Größe size	Farbe colour
AQ20	AUFPUTZGEHÄUSE NO CUBO OUTDOOR SURFACE MOUNT BOX	IP55	2M	<input type="checkbox"/> PW weiß-glanz polar white
AQ22	AUFPUTZGEHÄUSE NO CUBO OUTDOOR SURFACE MOUNT BOX	IP55	2x2M	<input checked="" type="checkbox"/> GY grau grey
AQ30	AUFPUTZGEHÄUSE NO CUBO OUTDOOR SURFACE MOUNT BOX	IP55	3M	
AQ31	AUFPUTZGEHÄUSE NO CUBO OUTDOOR SURFACE MOUNT BOX	IP55	3M	

## AUFPUTZGEHÄUSE NO CUBO IP55 2M



- AQ20PW  
 AQ20GY

- Aufputzgehäuse IP55 2M
- Aufputzbefestigung der Elemente
- IP55 geeignet für feuchte Räume
- entspricht CEI 23-48, EN 60670

## BOX NO CUBO IP55 2M

- box IP55 2M
- for surface mounting
- IP55 for usage in humid areas
- in accordance with CEI 23-48, EN 60670



## AUFPUTZGEHÄUSE NO CUBO IP55 2x2M



- AQ22PW  
 AQ22GY

- Aufputzgehäuse IP55 2x2M
- Aufputzbefestigung der Elemente
- IP55 geeignet für feuchte Räume
- entspricht CEI 23-48, EN 60670

## BOX NO CUBO IP55 2x2M

- box IP55 2x2M
- for surface mounting
- IP55 for usage in humid areas
- in accordance with CEI 23-48, EN 60670



## AUFPUTZGEHÄUSE NO CUBO IP55 3M



- AQ30PW  
 AQ30GY

- Aufputzgehäuse IP55 3M
- Aufputzbefestigung der Elemente
- IP55 geeignet für feuchte Räume
- entspricht CEI 23-48, EN 60670

## BOX NO CUBO IP55 3M

- box IP55 3M
- for surface mounting
- IP55 for usage in humid areas
- in accordance with CEI 23-48, EN 60670



## UNTERPUTZGEHÄUSE PO CUBO IP55 3M



- AQ31PW  
 AQ31GY

- Aufputzgehäuse IP55 3M
- Unterputzbefestigung der Elemente
- IP55 geeignet für feuchte Räume
- entspricht CEI 23-48, EN 60670

## BOX PO CUBO IP55 3M

- box IP55 3M
- for flush mounting
- IP55 for usage in humid areas
- in accordance with CEI 23-48, EN 60670





□ AQ21PW

UNTERPUTZGEHÄUSE PO CUBO IP55 2M

- Unterputzgehäuse IP55 2M
- kann mit allen Funktionselementen Modul kombiniert werden
- Unterputzbefestigung der Elemente
- IP55 geeignet für feuchte Räume
- entspricht CEI 23-48, EN 60670

*BOX PO CUBO IP55 2M*

- box IP55 2M
- can be combined with all Modul functional elements
- for flush mounting
- IP55 for usage in humid areas
- in accordance with CEI 23-48, EN 60670

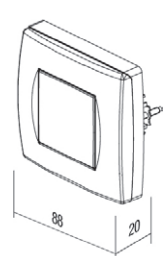
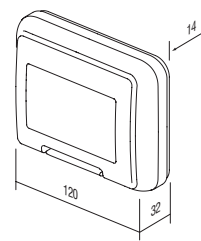
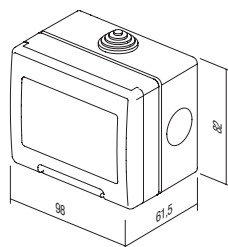
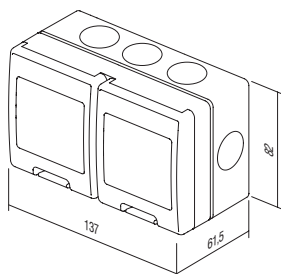
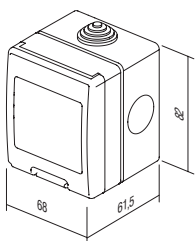

T R U N K I N G   S Y S T E M   A L U M I N I U M

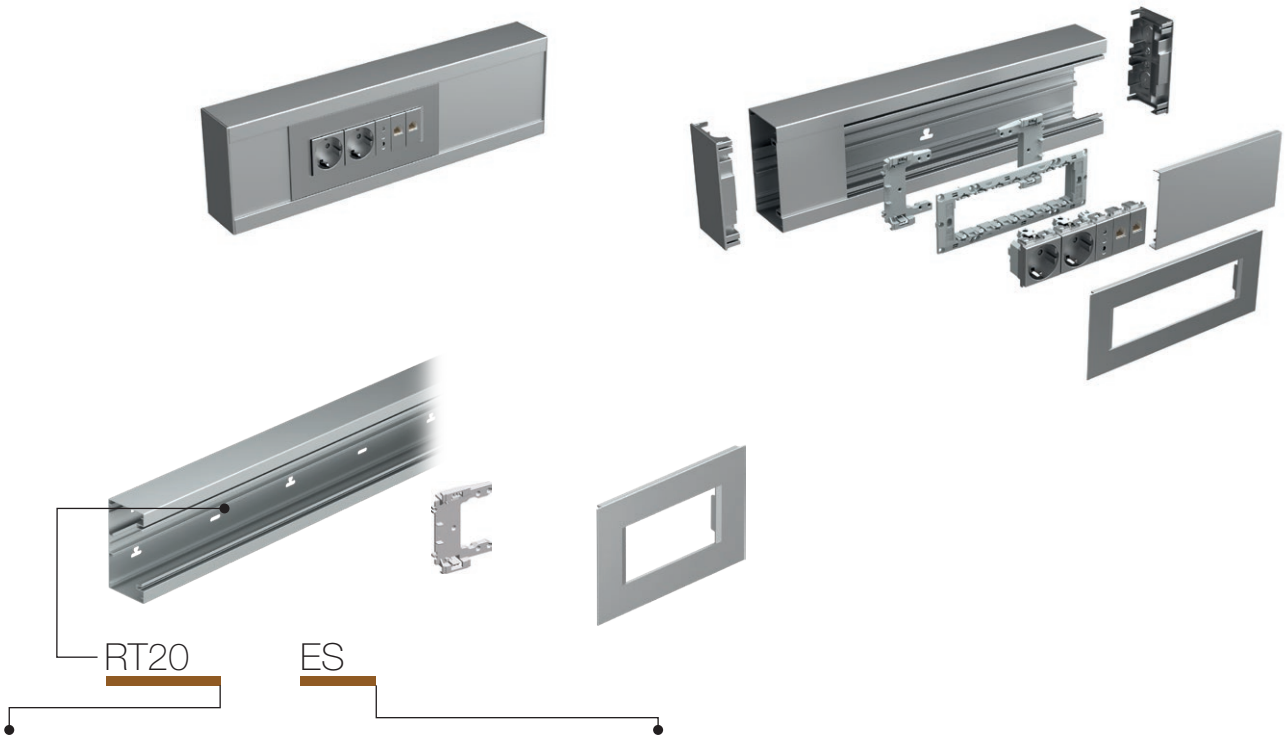

Typ type	Bezeichnung description	Größe size	Farbe colour
RT10	ADAPTER MA 92 ADAPTER MA 92	/	■ ES silber-matt elox silver-mat
RT12	RAHMEN MA 92 COVER PLATE MA 92	2/3M	□ PW weiß-matt (RAL 9016) white-mat
RT14	RAHMEN MA 92 COVER PLATE MA 92	4M	
⋮	⋮	⋮	

**ADAPTER MA 92**

RT10

- Adapter zur Befestigung der Montageträger 2/3M, 4M- bzw. 7M-Modul auf Kanal MA ohne Dose
- 2 Adapter je Träger
- entspricht EN 50085-1

**ADAPTER MA 92**

- adapter for fixing mounting frames 2/3M, 4M or 7M on MA trunking without box
- each mounting frame needs two adapters
- in accordance with EN 50085-1

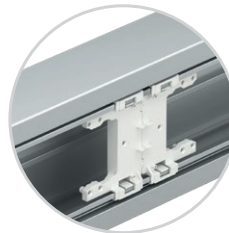
**RAHMEN MA 92 2/3M**

■ RT12ES  
□ RT12PW

- dekorativer Rahmen MA 2/3M
- entspricht EN 50085-1

**COVER PLATE MA 92 2/3M**

- decorative cover plate MA 2/3M
- in accordance with EN 50085-1

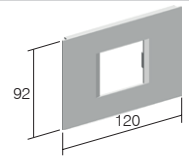
**RAHMEN MA 92 4M**

■ RT14ES  
□ RT14PW

- dekorativer Rahmen MA 4M
- entspricht EN 50085-1

**COVER PLATE MA 92 4M**

- decorative cover plate MA 4M
- in accordance with EN 50085-1

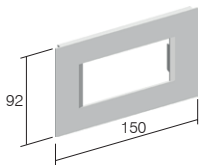
**RAHMEN MA 92 7M**

■ RT17ES  
□ RT17PW

- dekorativer Rahmen MA 7M
- entspricht EN 50085-1

**COVER PLATE MA 92 7M**

- decorative cover plate MA 7M
- in accordance with EN 50085-1

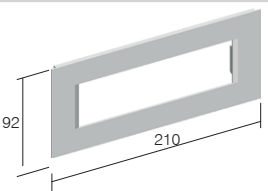
**KANALUNTERTEIL MA 130x65**



- RT20ES
- RT20PW

- Unterteil für Brüstungskanal aus Aluminium
- Höhe 130 mm, Länge 2m
- am Kanalboden befindet sich eine 35-mm-DIN-Erdungsschiene
- entspricht EN 50085-1

**TRUNKING BASE MA 130x65**

- trunking base from extruded aluminium
- height 130mm, length 2m
- DIN - rail 35mm shape on bottom
- in accordance with EN 50085-1

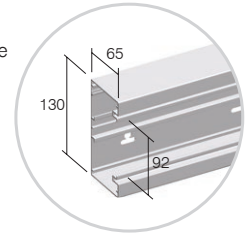

**KANALUNTERTEIL MA 165x65**



- RT21ES
- RT21PW

- Unterteil für Brüstungskanal aus Aluminium
- Höhe 165mm, Länge 2m
- am Kanalboden befindet sich eine 35-mm-DIN-Erdungsschiene
- entspricht EN 50085-1

**TRUNKING BASE MA 165x65**

- trunking base from extruded aluminium
- height 165mm, length 2m
- DIN - rail 35mm shape on bottom
- in accordance with EN 50085-1

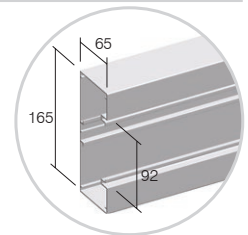

**FRONTABDECKUNG MA 92**



- RT25ES
- RT25PW

- Aluminiumdeckel zur Abdeckung des Unterteils
- Höhe 92mm, Länge 2m
- entspricht EN 50085-1

**FRONT COVER MA 92**

- front cover from extruded aluminium
- height 92mm, length 2m
- in accordance with EN 50085-1

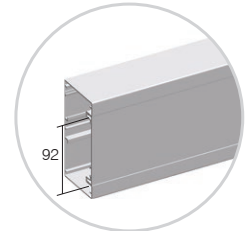

**TRENNWAND MA 43**



RT30

- Kanaltrennwand aus Polymer
- Tiefe 43 mm, Länge 2 m
- entspricht EN 50085-1

**CABLE SHELF MA 43**

- cable shelf from extruded polymer
- depth 43mm, length 2m
- in accordance with EN 50085-1

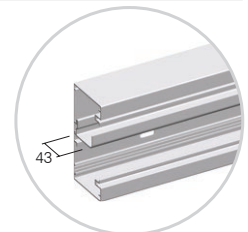

**TRENNWAND MA 43 AL**



RT31

- Kanaltrennwand aus Aluminium
- Tiefe 43 mm, Länge 2 m
- entspricht EN 50085-1

**CABLE SHELF MA 43 AL**

- cable shelf from extruded aluminium
- depth 43mm, length 2m
- in accordance with EN 50085-1

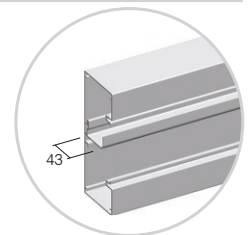

**TRENNWAND MA 43 AL DOPPELT**



RT32

- doppelte Kanaltrennwand aus Aluminium
- Tiefe 43 mm, Länge 2 m
- entspricht EN 50085-1

**CABLE SHELF MA 43 AL DOUBLE**

- double cable shelf from extruded aluminium
- depth 43mm, length 2m
- in accordance with EN 50085-1

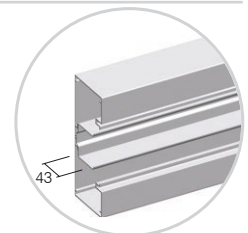

	<input checked="" type="checkbox"/> RT35ES <input type="checkbox"/> RT35PW	<p><b>ENDSTÜCK MA 130x65</b></p> <ul style="list-style-type: none"> <li>- Kanalendstück aus Polymer</li> <li>- Höhe 130mm</li> <li>- entspricht EN 50085-1</li> </ul> <p><i>STOP END MA 130x65</i></p> <ul style="list-style-type: none"> <li>- stop end element from polymer</li> <li>- height 130mm</li> <li>- in accordance with EN 50085-1</li> </ul>	
	<input checked="" type="checkbox"/> RT36ES <input type="checkbox"/> RT36PW	<p><b>ENDSTÜCK MA 165x65</b></p> <ul style="list-style-type: none"> <li>- Kanalendstück aus Metall</li> <li>- Höhe 165mm</li> <li>- entspricht EN 50085-1</li> </ul> <p><i>STOP END MA 165x65</i></p> <ul style="list-style-type: none"> <li>- stop end element from metal</li> <li>- height 165mm</li> <li>- in accordance with EN 50085-1</li> </ul>	
	RT38	<p><b>VERBINDUNGSSTÜCK MA 65</b></p> <ul style="list-style-type: none"> <li>- Kanalverbindungsstück aus Polymer</li> <li>- inkl. 2 Verbindungsstücke und Schrauben</li> <li>- entspricht EN 50085-1</li> </ul> <p><i>SET JOINING PIECE MA 65</i></p> <ul style="list-style-type: none"> <li>- joining piece from polymer</li> <li>- set contains two pieces and screws</li> <li>- in accordance with EN 50085-1</li> </ul>	
	<input checked="" type="checkbox"/> RT40ES <input type="checkbox"/> RT40PW	<p><b>UNIVERSALECK MA 130x65</b></p> <ul style="list-style-type: none"> <li>- Universal-Eckelement für Innen- und Außenecken</li> <li>- Höhe 130mm</li> <li>- entspricht EN 50085-1</li> </ul> <p><i>UNIVERSAL CORNER MA 130x65</i></p> <ul style="list-style-type: none"> <li>- universal corner element</li> <li>- height 130mm</li> <li>- in accordance with EN 50085-1</li> </ul>	
	<input checked="" type="checkbox"/> RT41ES <input type="checkbox"/> RT41PW	<p><b>UNIVERSALECK MA 165x65</b></p> <ul style="list-style-type: none"> <li>- Universal-Eckelement für Innen- und Außenecken</li> <li>- Höhe 165mm</li> <li>- entspricht EN 50085-1</li> </ul> <p><i>UNIVERSAL CORNER MA 165x65</i></p> <ul style="list-style-type: none"> <li>- universal corner element</li> <li>- height 165mm</li> <li>- in accordance with EN 50085-1</li> </ul>	
	RT42	<p><b>ERDUNGSKLEMME MA 2x A6.3</b></p> <ul style="list-style-type: none"> <li>- Klemme zur Erdung von Kanalunterteil und -Deckel</li> <li>- entspricht EN 50085-1</li> </ul> <p><i>EARTHING PIECE MA 2x A6.3</i></p> <ul style="list-style-type: none"> <li>- earthing piece for earthing of trunking base and front cover</li> <li>- in accordance with EN 50085-1</li> </ul>	

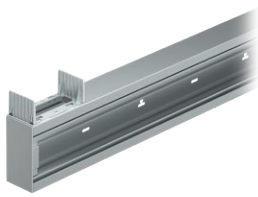

- RT43ES
- RT43PW

**FLACHWINKEL MA 130x65**

- Universal-Flachwinkel aus Aluminium für L-Verbindungen
- Höhe 130 mm, Länge 400mm
- entspricht EN 50085-1

*L-BEND MA 130x65*

- universal L bend element from aluminium
- height 130mm, length 400mm
- in accordance with EN 50085-1

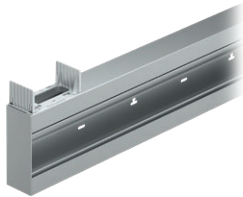
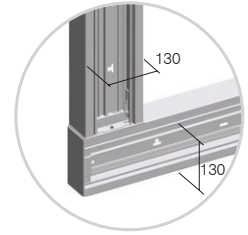

- RT44ES
- RT44PW

**FLACHWINKEL MA 165x65**

- Universal-Flachwinkel aus Aluminium für L-Verbindungen
- Höhe 165mm, Länge 400mm
- Verbindung auf MA 130x65
- entspricht EN 50085-1

*L-BEND MA 165x65*

- universal L bend element from aluminium
- height 165mm, length 400mm
- connection on MA 130x65
- in accordance with EN 50085-1

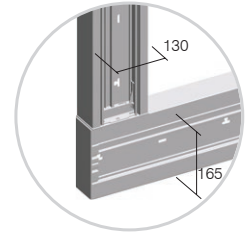

- RT45ES
- RT45PW

**T-STÜCK MA 130x65**

- Universal-T-Stück aus Aluminium für T-Verbindungen
- Höhe 130 mm, Länge 400mm
- entspricht EN 50085-1

*T-BEND MA 130x65*

- universal T bend element from aluminium
- height 130mm, length 400mm
- in accordance with EN 50085-1

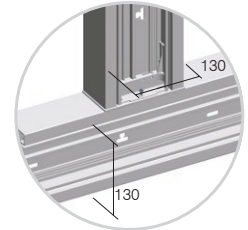

- RT46ES
- RT46PW

**T-STÜCK MA 165x65**

- Universal-T-Stück aus Aluminium für T-Verbindungen
- Höhe 165mm, Länge 400mm
- Verbindung auf MA 130x65
- entspricht EN 50085-1

*T-BEND MA 165x65*

- universal T bend element from aluminium
- height 165mm, length 400mm
- connection on MA 130x65
- in accordance with EN 50085-1

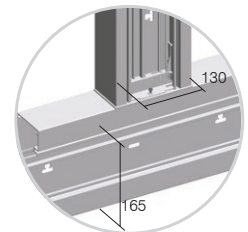

Modul MA basiert auf der Möglichkeit, 2M-, 4M- oder 7M-Elemente zu kombinieren.

*MA trunking is based on modular system making 2M, 4M or 7M combinations of elements*

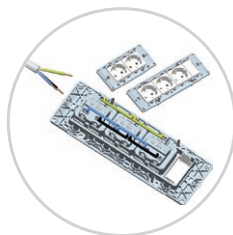

Modul MA beinhaltet spezielle Elemente für eine schnelle Montage.

*In Modul we provide special elements for quick installation*

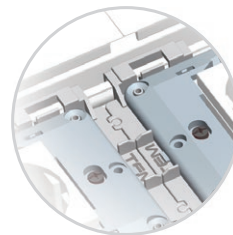

Mit den Adaptern MA ist eine exakte Positionierung auf den Kanalrand möglich.

*With Adapter MA exact positioning without extra effort is provided*

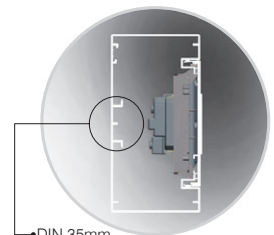

Ohne Montage-Box bedeutet mehr Platz für Kabel, DIN Leiste nach EN-60715.

*Mounted without box means more space for cables, DIN-rail base shape EN-60715*



TRUNKING SYSTEM ALUMINIUM



**BEFESTIGUNGSPLATTE EINFACH MA 130x65**



- RT50ES
- RT50PW

- zur Befestigung der Servicesäule MA 130 am Boden und/oder auf der Decke  
- entspricht EN 50085-1

*FIXING PLATE MA SINGLE 130x65*

- fixing plate for fixing trunking base MA130 on the floor and/or on the ceiling  
- in accordance with EN 50085-1



- RT51ES
- RT51PW

**BEFESTIGUNGSPLATTE DOPPELT MA 130x65**

- zur Befestigung von zwei Servicesäulen MA 130 am Boden und/oder auf der Decke  
- entspricht EN 50085-1

*FIXING PLATE MA DOUBLE 130x65*

- fixing plate for fixing two trunking bases MA130 on the floor and/or on the ceiling  
- in accordance with EN 50085-1



**SERVICESÄULE MA 130x65x500**

- RT52ES
- RT52PW

- Installationssäule MA  
- Höhe 500 mm  
- inkl. Montageträger 7M  
- entspricht EN 50085-1

*SERVICE POST MA 130x65x500*

- service post MA  
- height 500mm  
- mounting frame 7M included  
- in accordance with EN 50085-1

**SERVICESÄULE DOPPELT 130x130x500**

- RT53ES
- RT53PW

- Installationssäule doppelt MA  
- Höhe 500 mm  
- inkl. zwei Montageträger 7M  
- entspricht EN 50085-1

*SERVICE POST MA DOUBLE 130x130x500*

- service post MA double  
- height 500mm  
- mounting frames 7M included  
- in accordance with EN 50085-1

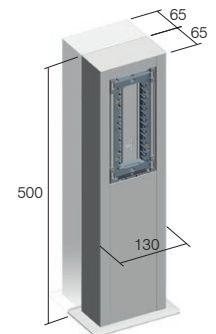

Kabelquerschnitt / Cable intersection mm <sup>2</sup>	Kabelkapazität / Cable cross-section (mm <sup>2</sup> )				
	1 Kabel / 1 wire	2 Kabel / 2 wires	3 Kabel / 3 wires	4 Kabel / 4 wires	5 Kabel / 5 wires
1,5	44	111	121	144	169
2,5	49	133	157	169	211
4	58	169	183	211	256
6	68	196	225	256	307

Kanal / Trunk	Kanalkapazität / Trunk capacity			
	MA 130x65 leer / empty	MA 130x65 mit Modul-Ausrüstung / with Modul switches and sockets	MA 165x65 leer / empty	MA 130x65 mit Modul-Ausrüstung / with Modul switches and sockets
Kapazität capacity max ø	7600 mm <sup>2</sup> 54 mm	5500 mm <sup>2</sup> 2x42 mm	9900 mm <sup>2</sup> 54 mm	7800 mm <sup>2</sup> 2x42 mm

# B O D E N D O S E N M T



RB33

Vertrieb

Typ type	Bezeichnung description	Technische Daten technical data
RB30	BODENDOSE FLOOR BOX	MT 7
RB31	UNTERSATZ FÜR BODENDOSEN MT 7 FLOOR BOX FLANGE	
RB33	BODENDOSE FLOOR BOX	MT 14
⋮	⋮	⋮

	RB30	RB33	RB36	RB40	RB43	RB46
a	170	260	350	170	260	350
b	260	260	260	260	260	260
X	140	230	320	140	230	320
Y	230	230	230	230	230	230

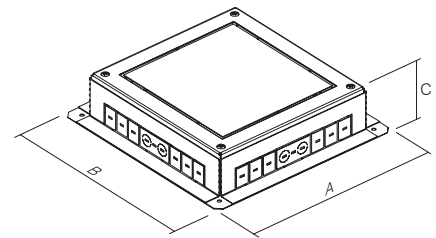
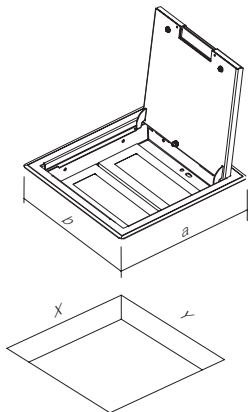

	RB31	RB34	RB37	RB41	RB44	RB47
A	250	340	430	250	340	430
B	340	340	340	340	340	340
C	95-125	95-125	95-125	125-150	125-150	125-150

**BODENDOSE MT 7**

RB30

- Bodendose MT 7
- Metall, Silber RAL 9006
- inkl. Montageträger MODUL 7M
- Einbauloch 140x230 mm, Tiefe min. 95mm
- Dicke des Deckel-Bodenansatzes bis 10 mm
- entspricht EN 50085-1 und EN 50085-2-2

**FLOOR BOX MT 7**

- floor box MT 7
- metal, colour silver RAL 9006
- mounting frame MODUL 7M included
- mounting dimensions 140x230mm, depth min 95mm
- floor lining thickness up to 10mm
- in accordance with EN 50085-1 and EN 50085-2-2

**BODENDOSE MT 7 H=88 mm**

RB40

- Bodendose MT 7
- Metall, Silber RAL 9006
- inkl. Montageträger MODUL 7M
- Einbauloch 140x230 mm, Tiefe min. 120 mm
- Dicke des Deckel-Bodenansatzes bis 10 mm
- entspricht EN 50085-1 und EN 50085-2-2

**FLOOR BOX MT 7 H=88mm**

- floor box MT 7
- metal, colour silver RAL 9006
- mounting frame MODUL 7M included
- mounting dimensions 140x230mm, depth min 120mm
- floor lining thickness up to 10mm
- in accordance with EN 50085-1 and EN 50085-2-2

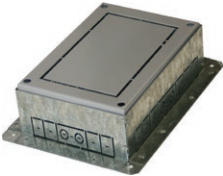
**UNTERSATZ FÜR BODENDOSEN MT 7**

RB31

- Untersatz für Bodendose für Deckel MT 7
- Metall, verzinkt
- für Montage in Pflaster oder Doppelboden
- Einstellhöhe 95-125mm
- entspricht EN 50085-1 und EN 50085-2-2

**FLOOR BOX FLANGE MT 7**

- floor box flange for box cover MT 7
- metal, galvanized
- for installation in a floor or double floor
- adjustable height 95-125mm
- in accordance with EN 50085-1 and EN 50085-2-2

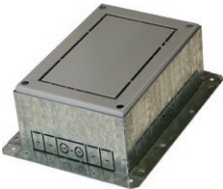
**UNTERSATZ FÜR BODENDOSEN MT 7 H=88 mm**

RB41

- Untersatz für Bodendose für Deckel MT 7 H=88 mm
- Metall, verzinkt
- für Montage in Pflaster oder Doppelboden
- Einstellhöhe 125-150 mm
- entspricht EN 50085-1 und EN 50085-2-2

**FLOOR BOX FLANGE MT 7 H=88mm**

- floor box flange for box cover MT 7 H=88mm
- metal, galvanized
- for installation in a floor or double floor
- adjustable height 125-150mm
- in accordance with EN 50085-1 and EN 50085-2-2

**BODENDOSE MT 14**

RB33

- Bodendose MT 14
- Metall, Silber RAL 9006
- inkl. Montageträger MODUL 2x7M
- Einbauloch 230x230 mm, Tiefe min. 95 mm
- Dicke des Deckel-Bodenansatzes bis 10 mm
- entspricht EN 50085-1 und EN 50085-2-2

**FLOOR BOX MT 14**

- floor box MT 14
- metal, colour silver RAL 9006
- mounting frame MODUL 2x7M included
- mounting dimensions 230x230mm, depth min 95mm
- floor lining thickness up to 10mm
- in accordance with EN 50085-1 and EN 50085-2-2

**BODENDOSE MT 14 H=88 mm**

RB43

- Bodendose MT 14
- Metall, Silber RAL 9006
- inkl. Montageträger MODUL 2x7M
- Einbauloch 230x230 mm, Tiefe min. 120 mm
- Dicke des Deckel-Bodenansatzes bis 10 mm
- entspricht EN 50085-1 und EN 50085-2-2

**FLOOR BOX MT 14 H=88mm**

- floor box MT 14
- metal, colour silver RAL 9006
- mounting frames MODUL 2x7M included
- mounting dimensions 230x230mm, depth min 120mm
- floor lining thickness up to 10mm
- in accordance with EN 50085-1 and EN 50085-2-2

UNTERSATZ FÜR BODENDOSEN MT 14

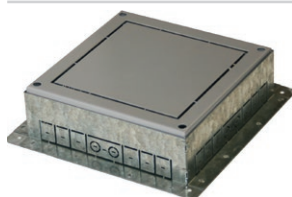

RB34

- Untersatz für Bodendose für Deckel MT 14
- Metall, verzinkt
- für Montage in Pflaster oder Doppelboden
- Einstellhöhe 95-125mm
- entspricht EN 50085-1 und EN 50085-2-2

*FLOOR BOX FLANGE MT 14*

- floor box flange for box cover MT 14
- metal, galvanized
- for installation in a floor or double floor
- adjustable height 95-125mm
- in accordance with EN 50085-1 and EN 50085-2-2

UNTERSATZ FÜR BODENDOSEN MT 14 H=88 mm

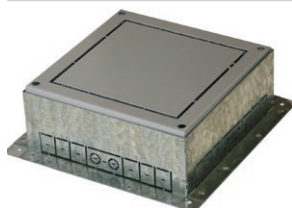

RB44

- Untersatz für Bodendose für Deckel MT 14 H=88 mm
- Metall, verzinkt
- für Montage in Pflaster oder Doppelboden
- Einstellhöhe 125-150 mm
- entspricht EN 50085-1 und EN 50085-2-2

*FLOOR BOX FLANGE MT 14 H=88mm*

- floor box flange for box cover MT 14 H=88mm
- metal, galvanized
- for installation in a floor or double floor
- adjustable height 125-150mm
- in accordance with EN 50085-1 and EN 50085-2-2

BODENDOSE MT 21



RB36

- Bodendose MT 21
- Metall, Silber RAL 9006
- inkl. Montageträger MODUL 3x7M
- Einbauloch 320x230 mm, Tiefe min. 95mm
- Dicke des Deckel-Bodenansatzes bis 10 mm
- entspricht EN 50085-1 und EN 50085-2-2

*FLOOR BOX MT 21*

- floor box MT 21
- metal, colour silver RAL 9006
- mounting frames MODUL 3x7M included
- mounting dimensions 320x230mm, depth min 95mm
- floor lining thickness up to 10mm
- in accordance with EN 50085-1 and EN 50085-2-2

BODENDOSE MT 21 H=88 mm



RB46

- Bodendose MT 21
- Metall, Silber RAL 9006
- inkl. Montageträger MODUL 3x7M
- Einbauloch 320x230 mm, Tiefe min. 120 mm
- Dicke des Deckel-Bodenansatzes bis 10 mm
- entspricht EN 50085-1 und EN 50085-2-2

*FLOOR BOX MT 21 H=88mm*

- floor box MT 21
- metal, colour silver RAL 9006
- mounting frames MODUL 3x7M included
- mounting dimensions 320x230mm, depth min 120mm
- floor lining thickness up to 10mm
- in accordance with EN 50085-1 and EN 50085-2-2

UNTERSATZ FÜR BODENDOSEN MT 21

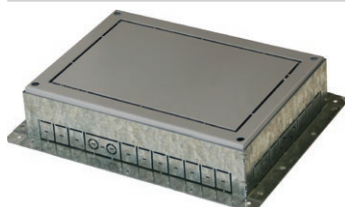

RB37

- Untersatz für Bodendose für Deckel MT 21
- Metall, verzinkt
- für Montage in Pflaster oder Doppelboden
- Einstellhöhe 95-125mm
- entspricht EN 50085-1 und EN 50085-2-2

*FLOOR BOX FLANGE MT 21*

- floor box flange for box cover MT 21
- metal, galvanized
- for installation in a floor or double floor
- adjustable height 95-125mm
- in accordance with EN 50085-1 and EN 50085-2-2

UNTERSATZ FÜR BODENDOSEN MT 21 H=88 mm

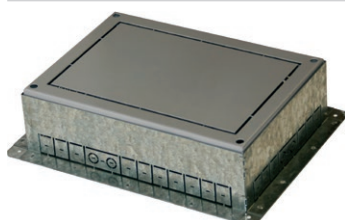

RB47

- Untersatz für Bodendose für Deckel MT 21 H=88 mm
- Metall, verzinkt
- für Montage in Pflaster oder Doppelboden
- Einstellhöhe 125-150 mm
- entspricht EN 50085-1 und EN 50085-2-2

*FLOOR BOX FLANGE MT 21 H=88mm*

- floor box flange for box cover MT 21 H=88mm
- metal, galvanized
- for installation in a floor or double floor
- adjustable height 125-150mm
- in accordance with EN 50085-1 and EN 50085-2-2

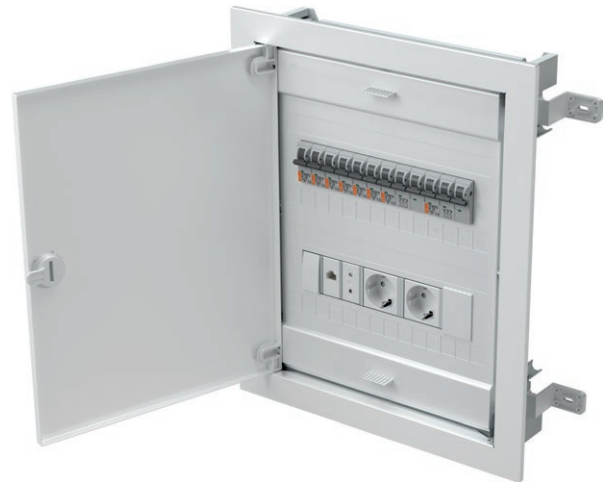
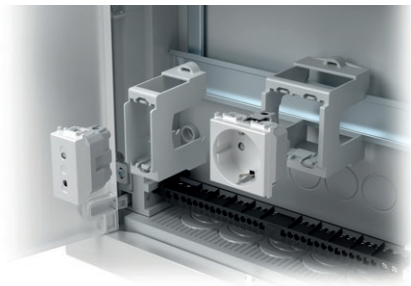

RB20

Typ type	Bezeichnung description	Technische Daten technical data
RB10	ADAPTER FÜR DIN-LEISTE ADAPTER FOR DIN RAIL	35mm 1M
RB11	ADAPTER FÜR DIN-LEISTE ADAPTER FOR DIN RAIL	35mm 2M
RB20	VERTEILERKASTEN DISTRIBUTION BOX	MO 12+2
⋮	⋮	⋮

## ADAPTER FÜR DIN-LEISTE 35mm 1M



RB10

- Adapter MODUL 1M
- für DIN-Leiste 35 mm
- entspricht EN 50022

## ADAPTER FOR DIN RAIL 35mm 1M

- adapter MODUL 1M
- for DIN rail 35mm
- in accordance with EN 50022

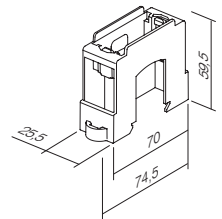

## ADAPTER FÜR DIN-LEISTE 35mm 2M



RB11

- Adapter MODUL 2M
- für DIN-Leiste 35 mm
- entspricht EN 50022

## ADAPTER FOR DIN RAIL 35mm 2M

- adapter MODUL 2M
- for DIN rail 35mm
- in accordance with EN 50022

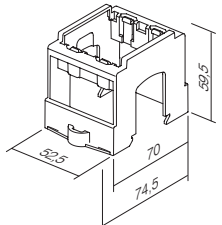

**VERTEILERKASTEN MO 12+2**



- RB20**
- Verteilerkasten 1-reihig MO 12+2MU
  - 400V~, Schutzklasse II, IP40
  - Metallrahmen und -Tür, weiß RAL 9016
  - inkl. Erdung- und Nullklemmen
  - Universalmontage in Ziegel
  - entspricht EN 60670-1 und IEC 60670-24

**DISTRIBUTION BOX MO 12+2**

- distribution box MO single row 12+2MU
- 400V~, Class II, IP40
- metal leveling frame and door, colour white RAL 9016
- neutral and earth conductor terminals enclosed
- for brick wall mounting
- in accordance with EN 60670-1 and IEC 60670-24

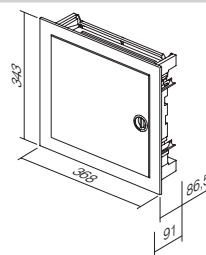

- RB20V0**
- einbau in Hohlwände
  - for hollow wall mounting

**VERTEILERKASTEN MO 24+4**



- RB21**
- Verteilerkasten 2-reihig MO 24+4MU
  - 400V~, Schutzklasse II, IP40
  - Metallrahmen und -Tür, weiß RAL 9016
  - inkl. Erdung- und Nullklemmen
  - Universalmontage in Ziegel
  - entspricht EN 60670-1 und IEC 60670-24

**DISTRIBUTION BOX MO 24+4**

- distribution box MO double row 24+4MU
- 400V~, Class II, IP40
- metal leveling frame and door, colour white RAL 9016
- neutral and earth conductor terminals enclosed
- for brick wall mounting
- in accordance with EN 60670-1 and IEC 60670-24

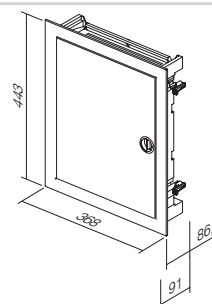

- RB21V0**
- einbau in Hohlwände
  - for hollow wall mounting

**VERTEILERKASTEN MO 36+6**



- RB22**
- Verteilerkasten 3-reihig MO 36+6MU
  - 400V~, Schutzklasse II, IP40
  - Metallrahmen und -Tür, weiß RAL 9016
  - inkl. Erdung- und Nullklemmen
  - Universalmontage in Ziegel
  - entspricht EN 60670-1 und IEC 60670-24

**DISTRIBUTION BOX MO 36+6**

- distribution box MO triple row 36+6 MU
- 400V~, Class II, IP40
- metal leveling frame and door, colour white RAL 9016
- neutral and earth conductor terminals enclosed
- for brick wall mounting
- in accordance with EN 60670-1 and IEC 60670-24

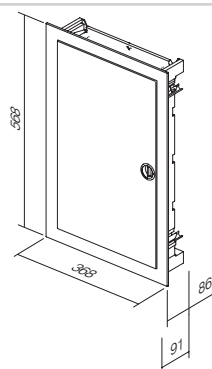

- RB22V0**
- einbau in Hohlwände
  - for hollow wall mounting

**VERTEILERKASTEN MO 48+8**



- RB23**
- Verteilerkasten 3-reihig MO 48+8MU
  - 400V~, Schutzklasse II, IP40
  - Metallrahmen und -Tür, weiß RAL 9016
  - inkl. Erdung- und Nullklemmen
  - Universalmontage in Ziegel
  - entspricht EN 60670-1 und IEC 60670-24

**DISTRIBUTION BOX MO 48+8**

- distribution box MO quad row 48+8 MU
- 400V~, Class II, IP40
- metal leveling frame and door, colour white RAL 9016
- neutral and earth conductor terminals enclosed
- for brick wall mounting
- in accordance with EN 60670-1 and IEC 60670-24

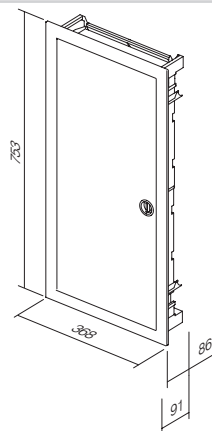

- RB23V0**
- einbau in Hohlwände
  - for hollow wall mounting

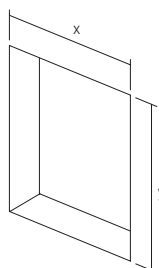

	RB20 RB20V0	RB21 RB21V0	RB22 RB22V0	RB23 RB23V0
x	314	314	314	314
y	314	414	539	724







ekonomik<sup>®</sup>



Planned for excellence  
Style is essential



ERGO

METAL

SOFT

Das neutrale, kompakte, elegante Design passt sich jeder Umgebung an, in der Sie wohnen und arbeiten. Im Interieur tritt es nicht hervor, sondern lebt damit harmonisch auf.

A neutral, compact, elegant design is adjustable to every working or living area. It does not stick out from the interior, but rather harmonically fits into it.





# Geplante Perfektion

## Der Stil ist wichtig



Die reine Linie ist sanft abgerundet – eine gut durchdachte Ergonomie speziell für Sie.

A pure line is slightly curved - well considered ergonomics especially for you.



Sie können zwischen glänzenden reflektierenden Flächen und einem modernen Metalldesign wählen.  
You can choose between shiny reflective surfaces and modern metallic look.



Die Weichheit der Form passt sich sowohl modernen wie auch klassischen Interieurs an.

The softness of the form will find its place in modern as well as in classic interiors.

HARMONY

REFLEX

UV PROTECT

Wünsche können sehr unterschiedlich sein. Genau aus diesem Grund haben wir für Sie mit größter Sorgfalt verschiedene Möglichkeiten gewählt, die Ihnen die richtige Antwort anbieten. Die neutrale Farbpalette wird Ihr Ambiente ergänzen – und nicht begrenzen.

Desires can be very different. Therefore we have carefully selected possibilities for you, which can offer you the right answer. A neutral palette of colours will only complement your ambient - it will not restrict it.

Press and the world will spring to life  
Colourful landscape between walls



Die Reflexempfindungen werden durch glänzende Polymermaterialien in weißer und perlweißer (beige) Farbe angeboten.

Shiny polymer materials in white and beige colours enable reflective mood.



Modern und neutral ist auch der dekorative Metallanstrich.

Selected decorative metallic coat is at the same time modern and neutral.

# Nur ein Druck und die Welt lebt auf Lebendig bunte Räume zwischen den Wänden



Für alle, die Pastellfarben mögen, ist der Ekonomik Color die richtige Wahl.

For those who want to play with pastel colours Ekonomik Color represents a perfect solution.



Seine Robustheit und Widerstandsfestigkeit (UV) sind durch das duroplastische Material (Color) gesichert.

Robustness and high resistance to external effects (UV) are secured by duroplastic materials (Color line).

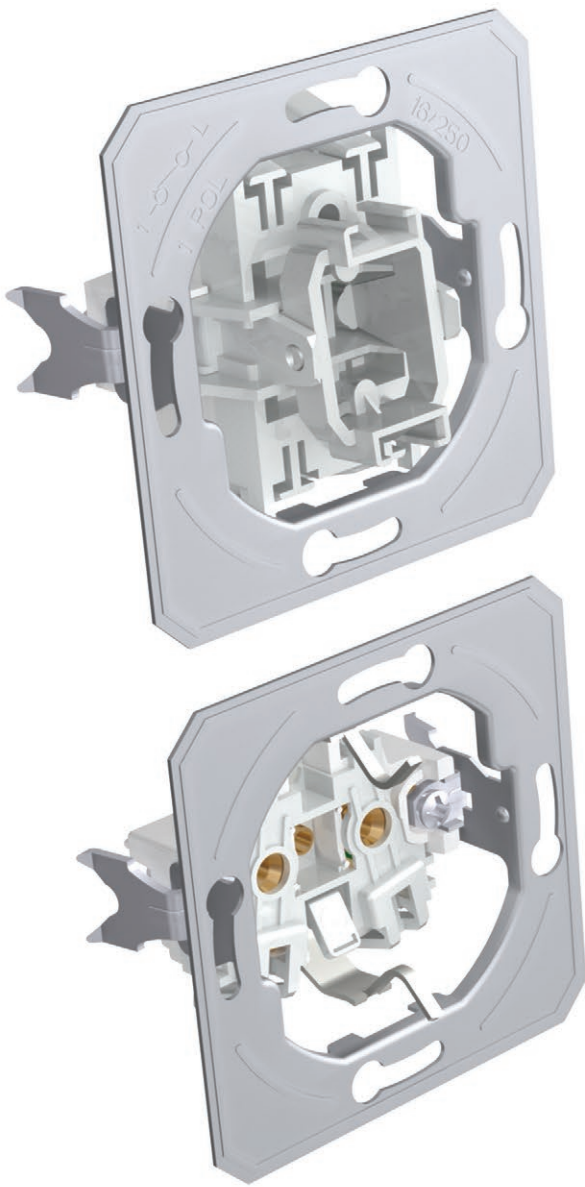

VERTICAL

HORIZONTAL

SAVE SPACE



Mit verschiedenen Kombinationen können Sie Platz an der Wand sparen. Wenn wenig Platz vorhanden ist, dann ist die vertikale Entscheidung richtig.

With combining you save space on the wall. When faced with a limited space, »vertically« is the right decision.



Kombinieren Sie nach Lust und Laune.

Combine as you please.



Die sichtbaren Elemente werden einfach demontiert. Auch die Malermeister werden Ihnen dankbar sein.

Visible elements can be easily taken apart. Painters will be grateful to you.



Prolonge your day with a touch  
Simplified living

## Mit einem Druck den Tag verlängern Vereinfachtes Wohnen

Ekonomik ist die Lösung für das System der runden Standarddosen. Es ist für einfache wie auch anspruchsvollere Installationen, Neubauten und Umbauarbeiten geeignet. Das System zeichnet sich durch schraublose Kontakte aus, die Ihnen viel Zeit beim Einbau der Elemente ersparen.

Ekonomik is a solution for the system of standardized round installations boxes. It can be used for simple as well as more demanding installations, new buildings and adaptations. The system is characterised by plug-in contacts which save time during installation of elements.

# Das Wohlfühlen in sicherem Unterschlupf Volles Vertrauen in die gute Konstruktion

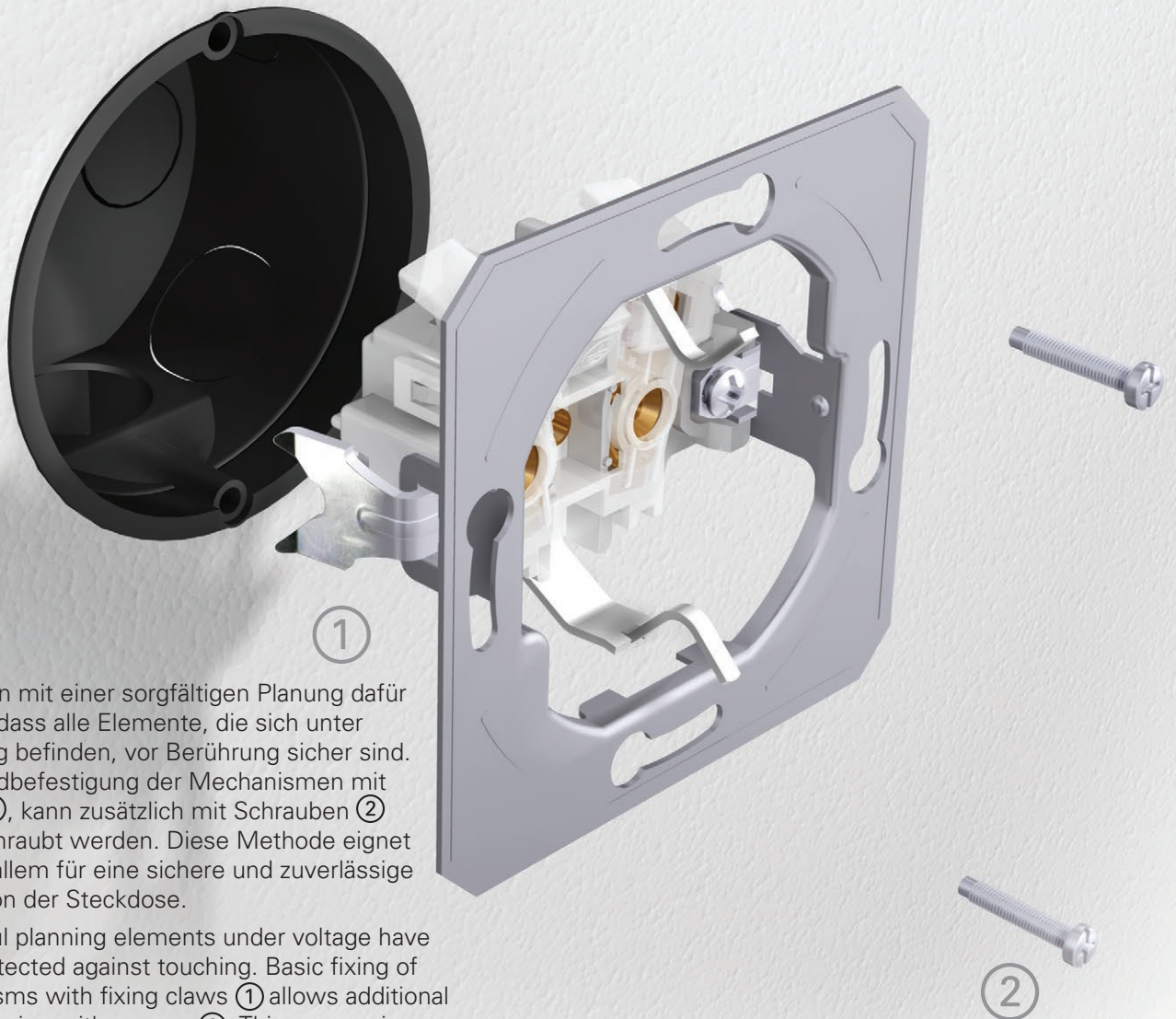

Wir haben mit einer sorgfältigen Planung dafür gesorgt, dass alle Elemente, die sich unter Spannung befinden, vor Berührung sicher sind. Die Grundbefestigung der Mechanismen mit Krallen ①, kann zusätzlich mit Schrauben ② festgeschraubt werden. Diese Methode eignet sich vor allem für eine sichere und zuverlässige Installation der Steckdose.

By careful planning elements under voltage have been protected against touching. Basic fixing of mechanisms with fixing claws ① allows additional strengthening with screws ②. This manner is especially appropriate for safe and reliable fixing of sockets.

**SIMPLE**

**FAST**

**FLEX**

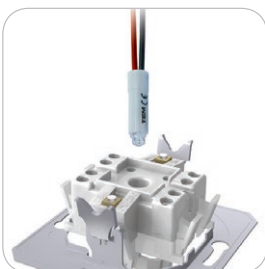

Die gut durchdachte Konstruktion des Schalters ermöglicht auch eine einfache nachträgliche Beleuchtung.

A well-planned switch construction makes easy illumination possible also subsequently.



Die schraublosen Kontakte ermöglichen einen schnellen und zuverlässigen Anschluss der Leitungen. An einem Kontakt können zwei Leitungen mit verschiedenen Durchmesser angeschlossen werden.

Plug-in contacts enable quick and reliable attachment of wires. Two wires of different diameters can be attached to the same contact.



Erleichtern Sie sich die Arbeit mit schon zusammengesetzten Dosen, die Ihnen die richtigen Abstände gewährleisten.

Easy-fitting installation boxes will make your work easier. Proper lengths are guaranteed.



## Feeling well in a safe shelter Total confidence in a good construction

SAFE

THRUST

CERTIFIED

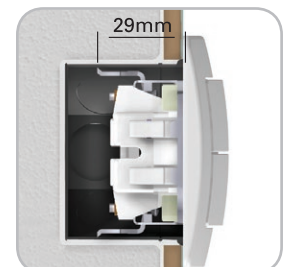

Die Krallen ermöglichen eine tiefere Befestigung (auch an Fliesen usw.).

Fixing claws enable deeper fixing (also through ceramic tiles, etc.)



Alle Schalter haben auf der Rückseite eine genaue Identifikation.

All switches have a clear identification in the back.

Die Schalter sind gemäß den internationalen Normen geprüft, die die Sicherheit und eine lange Lebensdauer gewährleisten.

Switches were tested according to international standards which guarantee safety and long life span.



Für eine zuverlässige Schaltung sorgen Kontakte aus einer Silberlegierung (AgNi).

Contacts made of silver alloy (Ag-Ni) guarantee safe switching.

TEM





<p>SCHALTER SE SWITCHES SE</p>		188
<p>WIPPEN TE BUTTONS TE</p>		192
<p>BELEUCHTUNG IA ILLUMINATION IA</p>		193
<p>STECKDOSEN VE SOCKETS VE</p>		196
<p>KOMMUNIKATION KE COMMUNICATIONS KE</p>		199
<p>DECKEL PE COVERS PE</p>		204
<p>ELEKTRONIK EE ELECTRONICS EE</p>		205
<p>ZUBEHÖR AE ACCESSORIES AE</p>		210
<p>RAHMEN OE SURROUNDS OE</p>		212

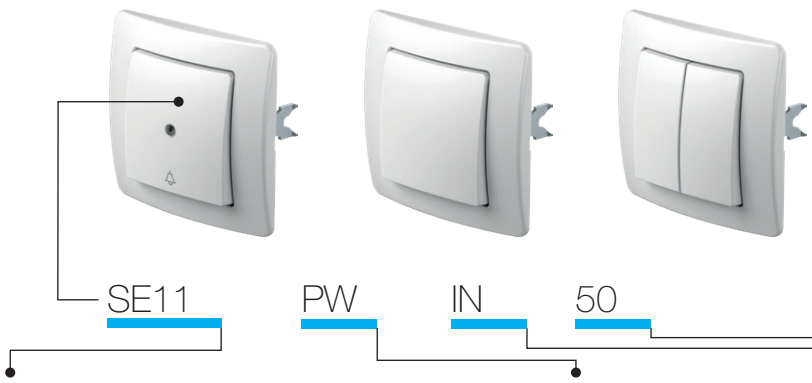

Typ type	Bezeichnung description	Technische Daten technical data	Farbe colour	Optionsbezeichnung 1 optional data 1	Optionsbezeichnung 2 optional data 2
SE10	SCHALTER 1-POLIG SWITCH 1WAY	10AX 250V~	<input type="checkbox"/> PW weiß-glänzend polar white	NT neutral neutral	50
SE11	TASTER 1-POLIG PUSH BUTTON 1WAY	10A 250V~	<input type="checkbox"/> IW beige-glänzend ivory white	IN Indikator indicator	51
SE22	SCHALTER 2-POLIG SWITCH 2POLE	16AX 250V~	<input type="checkbox"/> ES silber-matt elox silver		03
...	...	...	<input type="checkbox"/> CO weiß, Duroplast white thermoset		04
...	...	...	<input type="checkbox"/> NB schwarz-glänzend night black		...

SCHALTER 1-POLIG 10AX 250V~



SE10

- 10AX 250V~, Typ SE10
- entspricht EN 60669-1
- Steckklemmen 1,5-2,5 mm<sup>2</sup>



SWITCH 1WAY 10AX 250V~  
- 10AX 250V~, type SE10  
- in accordance with EN 60669-1  
- plug-in contacts 1.5-2.5mm<sup>2</sup>

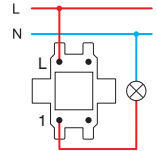

TASTER 1-POLIG 10A 250V~



SE11

- 10A 250V~, Typ SE11
- entspricht EN 60669-1
- Steckklemmen 1,5-2,5 mm<sup>2</sup>

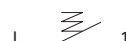

PUSH BUTTON 1WAY 10A 250V~  
- 10A 250V~, type SE11  
- in accordance with EN 60669-1  
- plug-in contacts 1.5-2.5mm<sup>2</sup>

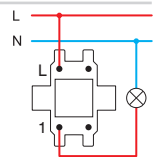

SCHALTER 2-POLIG 16AX 250V~



SE22

- 16AX 250V~, Typ SE22
- entspricht EN 60669-1
- Schraubklemmen 1,5-2,5mm<sup>2</sup>
- Nur in Kombination mit Wippe TE10\_NT03

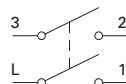

SWITCH 2POLE 16AX 250V~  
- 16AX 250V~, type SE22  
- in accordance with EN 60669-1  
- screw contacts 1.5-2.5mm<sup>2</sup>  
- only in combination with button TE10\_NT03

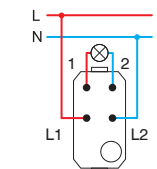

SCHALTER SERIEN 10AX 250V~



SE50

- 10AX 250V~, Typ SE50
- entspricht EN 60669-1
- Steckklemmen 1,5-2,5 mm<sup>2</sup>

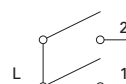

SWITCH 2GANG-1WAY 10AX 250V~  
- 10AX 250V~, type SE50  
- in accordance with EN 60669-1  
- plug-in contacts 1.5-2.5mm<sup>2</sup>

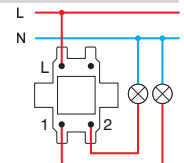

**TASTER SERIEN 10A 250V~**



SE51

- 10A 250V~, Typ SE51
- entspricht EN 60669-1
- Steckklemmen 1,5-2,5 mm<sup>2</sup>

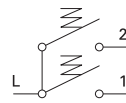

**PUSH BUTTON 2GANG-1WAY 10A 250V~**

- 10A 250V~, type SE51
- in accordance with EN 60669-1
- plug-in contacts 1.5-2.5mm<sup>2</sup>

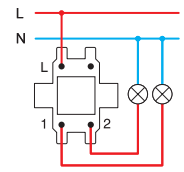

**SCHALTER JALOUSIE 10AX 250V~**



SE52

- 10AX 250V~, Typ SE52
- entspricht EN 60669-1
- Steckklemmen 1,5-2,5 mm<sup>2</sup>
- mit mechanischer Verriegelung

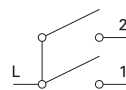

**SWITCH SHUTTERS 10AX 250V~**

- 10AX 250V~, type SE52
- in accordance with EN 60669-1
- plug-in contacts 1.5-2.5mm<sup>2</sup>
- with mechanical interblock

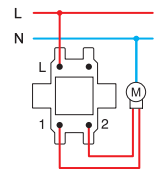

**TASTER JALOUSIE 10A 250V~**



SE53

- 10A 250V~, Typ SE53
- entspricht EN 60669-1
- Steckklemmen 1,5-2,5 mm<sup>2</sup>
- mit mechanischer Verriegelung

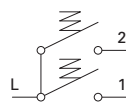

**PUSH BUTTON SHUTTERS 10A 250V~**

- 10A 250V~, type SE53
- in accordance with EN 60669-1
- plug-in contacts 1.5-2.5mm<sup>2</sup>
- with mechanical interblock

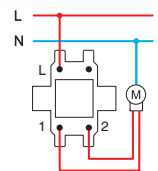

**SCHALTER WECHSEL 10AX 250V~**



SE60

- 10AX 250V~, Typ SE60
- entspricht EN 60669-1
- Steckklemmen 1,5-2,5 mm<sup>2</sup>

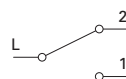

**SWITCH 2WAY 10AX 250V~**

- 10AX 250V~, type SE60
- in accordance with EN 60669-1
- plug-in contacts 1.5-2.5mm<sup>2</sup>

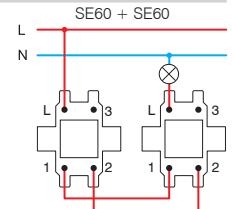

**SCHALTER DOPPEL AUS/WECHSEL 10AX 250V~**

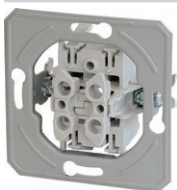

SE63

- 10AX 250V~, Typ SE63
- entspricht EN 60669-1
- Steckklemmen 1,5-2,5 mm<sup>2</sup>

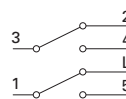

**SWITCH DOUBLE 2WAY 10AX 250V~**

- 10AX 250V~, type SE63
- in accordance with EN 60669-1
- plug-in contacts 1.5-2.5mm<sup>2</sup>

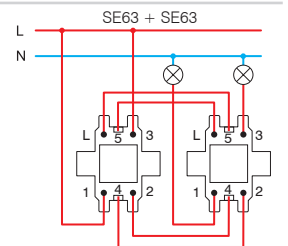

**SCHALTER KREUZ 10AX 250V~**



SE70

- 10AX 250V~, Typ SE70
- entspricht EN 60669-1
- Steckklemmen 1,5-2,5 mm<sup>2</sup>



**SWITCH INTERMEDIATE 10AX 250V~**

- 10AX 250V~, type SE70
- in accordance with EN 60669-1
- plug-in contacts 1.5-2.5mm<sup>2</sup>

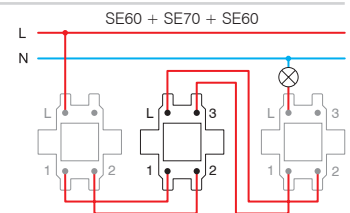



- SE10PW
- SE10IW
- SE10ES
- SE10CO
- SE10NB

SCHALTER 1-POLIG 10AX 250V~

- 10AX 250V~, Typ SE10
- entspricht EN 60669-1
- Steckklemmen 1,5-2,5 mm<sup>2</sup>

*SWITCH 1WAY 10AX 250V~*  
 - 10AX 250V~, type SE10  
 - in accordance with EN 60669-1  
 - plug-in contacts 1.5-2.5mm<sup>2</sup>



- SE10PWIN
- SE10IWIN
- SE10ESIN
- SE10COIN
- SE10NBIN

SCHALTER 1-POLIG 10AX 250V~ \_\_ IN

- IN Indikator
- 10AX 250V~, Typ SE10
- entspricht EN 60669-1
- Steckklemmen 1,5-2,5 mm<sup>2</sup>

*SWITCH 1WAY 10AX 250V~ \_\_ IN*  
 - IN indicator  
 - 10AX 250V~, type SE10  
 - in accordance with EN 60669-1  
 - plug-in contacts 1.5-2.5mm<sup>2</sup>



- SE11PW
- SE11IW
- SE11ES
- SE11CO
- SE11NB

TASTER 1-POLIG 10A 250V~

- 10A 250V~, Typ SE11
- entspricht EN 60669-1
- Steckklemmen 1,5-2,5 mm<sup>2</sup>

*PUSH BUTTON 1WAY 10A 250V~*  
 - 10A 250V~, type SE11  
 - in accordance with EN 60669-1  
 - plug-in contacts 1.5-2.5mm<sup>2</sup>



- SE11PWTI50
- SE11IWTI50
- SE11ESTI50
- SE11COTI50
- SE11NBTI50

TASTER 1-POLIG 10A 250V~ \_\_ TI 50

- TI 50 Indikator Klingel + Glühlampe
- 10A 250V~, Typ SE11
- entspricht EN 60669-1
- Steckklemmen 1,5-2,5 mm<sup>2</sup>

*PUSH BUTTON 1WAY 10A 250V~ \_\_ TI 50*  
 - TI 50 indicator bell+neon lamp  
 - 10A 250V~, type SE11  
 - in accordance with EN 60669-1  
 - plug-in contacts 1.5-2.5mm<sup>2</sup>



- SE11PWTI51
- SE11IWTI51
- SE11ESTI51
- SE11COTI51
- SE11NBTI51

TASTER 1-POLIG 10A 250V~ \_\_ TI 51

- TI 51 Indikator Lampe + Glühlampe
- 10A 250V~, Typ SE11
- entspricht EN 60669-1
- Steckklemmen 1,5-2,5 mm<sup>2</sup>

*PUSH BUTTON 1WAY 10A 250V~ \_\_ TI 51*  
 - TI 51 indicator light+neon lamp  
 - 10A 250V~, type SE11  
 - in accordance with EN 60669-1  
 - plug-in contacts 1.5-2.5mm<sup>2</sup>



- SE11PWIL
- SE11IWIL
- SE11ESIL
- SE11COIL
- SE11NBIL

TASTER 1-POLIG 10A 250V~ \_\_ IL

- IL mit Namensschild
- 10A 250V~, Typ SE11
- entspricht EN 60669-1
- Steckklemmen 1,5-2,5 mm<sup>2</sup>

*PUSH BUTTON 1WAY 10A 250V~ \_\_ IL*  
 - IL inscription plate  
 - 10A 250V~, type SE11  
 - in accordance with EN 60669-1  
 - plug-in contacts 1.5-2.5mm<sup>2</sup>



- SE22PWIN03
- SE22IWIN03
- SE22ESIN03
- SE22NBIN03

SCHALTER 2-POLIG 16AX 250V~ \_\_ IN 03

- IN 03 neutral 0-1
- 16AX 250V~, Typ SE22
- entspricht EN 60669-1
- Steckklemmen 1,5-2,5 mm<sup>2</sup>

*SWITCH 2POLE 16AX 250V~ \_\_ IN 03*  
 - IN 03 neutral 0-1  
 - 16AX 250V~, type SE22  
 - in accordance with EN 60669-1  
 - screw contacts 1.5-2.5mm<sup>2</sup>



	<ul style="list-style-type: none"> <li><input type="checkbox"/> SE50PW</li> <li><input type="checkbox"/> SE50IW</li> <li><input type="checkbox"/> SE50ES</li> <li><input type="checkbox"/> SE50CO</li> <li><input type="checkbox"/> SE50NB</li> </ul>	<b>SCHALTER SERIEN 10AX 250V~</b>	<ul style="list-style-type: none"> <li>- 10AX 250V~, Typ SE50</li> <li>- entspricht EN 60669-1</li> <li>- Steckklemmen 1,5–2,5 mm<sup>2</sup></li> </ul>	
	<ul style="list-style-type: none"> <li><input type="checkbox"/> SE51PW</li> <li><input type="checkbox"/> SE51IW</li> <li><input type="checkbox"/> SE51ES</li> <li><input type="checkbox"/> SE51CO</li> <li><input type="checkbox"/> SE51NB</li> </ul>	<b>TASTER SERIEN 10A 250V~</b>	<ul style="list-style-type: none"> <li>- 10A 250V~, Typ SE51</li> <li>- entspricht EN 60669-1</li> <li>- Steckklemmen 1,5–2,5 mm<sup>2</sup></li> </ul>	
	<ul style="list-style-type: none"> <li><input type="checkbox"/> SE52PWNT09</li> <li><input type="checkbox"/> SE52IWNT09</li> <li><input type="checkbox"/> SE52ESNT09</li> <li><input type="checkbox"/> SE52CONT09</li> <li><input type="checkbox"/> SE52NBNT09</li> </ul>	<b>SCHALTER JALOUSIE 10AX 250V~ __ NT 09</b>	<ul style="list-style-type: none"> <li>- NT 09 neutral aufwärts-abwärts</li> <li>- 10AX 250V~, Typ SE52</li> <li>- entspricht EN 60669-1</li> <li>- Steckklemmen 1,5–2,5 mm<sup>2</sup></li> <li>- mit mechanischer Verriegelung</li> </ul>	
	<ul style="list-style-type: none"> <li><input type="checkbox"/> SE53PWNT09</li> <li><input type="checkbox"/> SE53IWNT09</li> <li><input type="checkbox"/> SE53ESNT09</li> <li><input type="checkbox"/> SE53CONT09</li> <li><input type="checkbox"/> SE53NBNT09</li> </ul>	<b>TASTER JALOUSIE 10A 250V~ __ NT 09</b>	<ul style="list-style-type: none"> <li>- NT 09 neutral aufwärts-abwärts</li> <li>- 10A 250V~, Typ SE53</li> <li>- entspricht EN 60669-1</li> <li>- Steckklemmen 1,5–2,5 mm<sup>2</sup></li> <li>- mit mechanischer Verriegelung</li> </ul>	
	<ul style="list-style-type: none"> <li><input type="checkbox"/> SE60PW</li> <li><input type="checkbox"/> SE60IW</li> <li><input type="checkbox"/> SE60ES</li> <li><input type="checkbox"/> SE60CO</li> <li><input type="checkbox"/> SE60NB</li> </ul>	<b>SCHALTER WECHSEL 10AX 250V~</b>	<ul style="list-style-type: none"> <li>- 10AX 250V~, Typ SE60</li> <li>- entspricht EN 60669-1</li> <li>- Steckklemmen 1,5–2,5 mm<sup>2</sup></li> </ul>	
	<ul style="list-style-type: none"> <li><input type="checkbox"/> SE63PW</li> <li><input type="checkbox"/> SE63IW</li> <li><input type="checkbox"/> SE63ES</li> <li><input type="checkbox"/> SE63CO</li> <li><input type="checkbox"/> SE63NB</li> </ul>	<b>SCHALTER DOPPEL AUS/WECHSEL 10AX 250V~</b>	<ul style="list-style-type: none"> <li>- 10AX 250V~, Typ SE63</li> <li>- entspricht EN 60669-1</li> <li>- Steckklemmen 1,5–2,5 mm<sup>2</sup></li> </ul>	
	<ul style="list-style-type: none"> <li><input type="checkbox"/> SE70PW</li> <li><input type="checkbox"/> SE70IW</li> <li><input type="checkbox"/> SE70ES</li> <li><input type="checkbox"/> SE70CO</li> <li><input type="checkbox"/> SE70NB</li> </ul>	<b>SCHALTER KREUZ 10AX 250V~</b>	<ul style="list-style-type: none"> <li>- 10AX 250V~, Typ SE70</li> <li>- entspricht EN 60669-1</li> <li>- Steckklemmen 1,5–2,5 mm<sup>2</sup></li> </ul>	

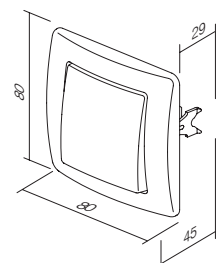
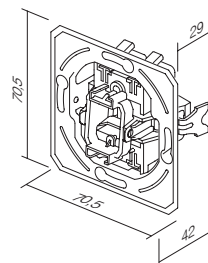

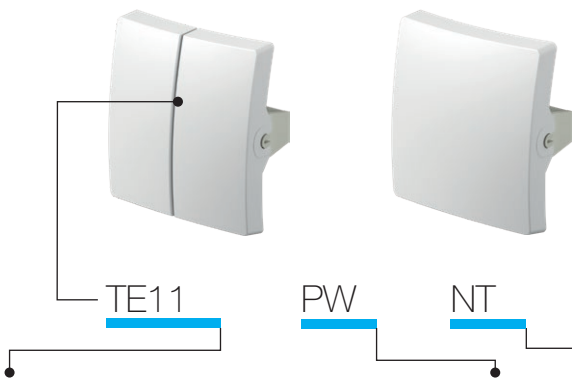







TE11

PW

NT

09

Typ type	Bezeichnung description	Farbe colour	Optionsbezeichnung 1 optional data 1	Optionsbezeichnung 2 optional data 2
TE10	WIPPE NORMAL BUTTON 1GANG	<input type="checkbox"/> PW weiß-glänzend polar white	 NT neutral neutral	 50
TE11	WIPPE SERIEN BUTTON 2GANG	<input type="checkbox"/> IW beige-glänzend ivory white	 IN Indikator indicator	 51
...	...	<input type="checkbox"/> ES silber-matt elox silver		 03
...	...	<input type="checkbox"/> CO weiß, Duroplast white thermoset		 04
...	...	<input type="checkbox"/> NB schwarz-glänzend night black		...

WIPPE NORMAL



- TE10PW
- TE10IW
- TE10ES
- TE10CO
- TE10NB

- Wippe mit Wippenträger  
**BUTTON 1GANG**  
- button together with carrier



WIPPE MIT INDIKATOR

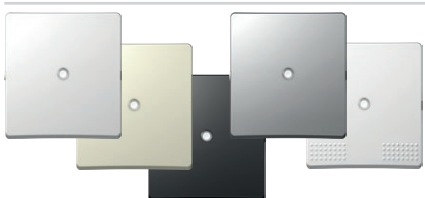

- TE10PWIN
- TE10IWIN
- TE10ESIN
- TE10COIN
- TE10NBIN

- Wippe mit Wippenträger  
**BUTTON INDICATOR**  
- button together with carrier



WIPPE MIT NAMENSCHILD

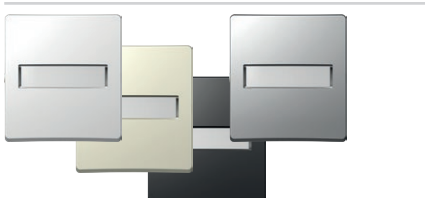

- TE13PWIL
- TE13IWIL
- TE13ESIL
- TE13NBIL

- Wippe mit Wippenträger und Namensschild  
**BUTTON WITH INSCRIPTION PLATE**  
- button together with carrier, with inscription plate



WIPPE SERIEN



- TE11PW
- TE11IW
- TE11ES
- TE11CO
- TE11NB

- Wippe serien mit Wippenträger  
**BUTTON 2GANG**  
- button 2gang together with carrier

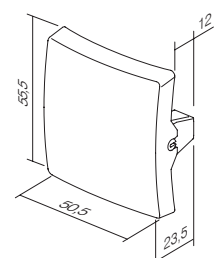
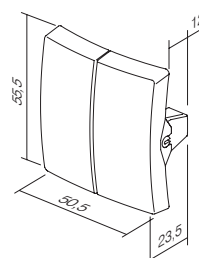



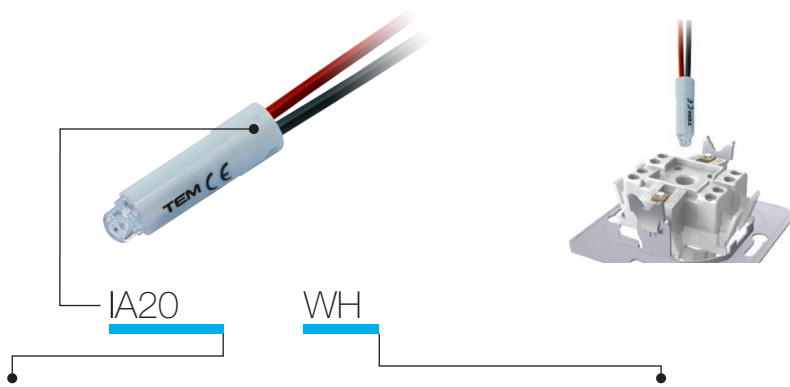

Typ type	Bezeichnung description	Technische Daten technical data	Farbe colour
IA10	GLÜHLAMPE NEON LAMP	230V~ 0,34W	<input type="checkbox"/> WH weiß white
IA20	LED-LAMPE LED LAMP	230V~ 0,40W	<input checked="" type="checkbox"/> BL blau blue
IA21	LED-LAMPE LED LAMP	24V AC/DC 0,20W	<input checked="" type="checkbox"/> RD rot red
⋮	⋮	⋮	<input checked="" type="checkbox"/> GR grün green
⋮	⋮	⋮	<input checked="" type="checkbox"/> OR orange orange

**GLÜHLAMPE 230V~ 0,34 W**



IA10OR

- zur Kontrollbeleuchtung, Beleuchtung oder ständige Beleuchtung des Schalters
  - in Kombination mit Wippe mit einem Indikator
- NEON LAMP 230V~ 0,34W*
- for indication, illumination or constant illumination of switch
  - in combination with button with indicator

**LED-LAMPE 230V AC/DC 0,40 W**

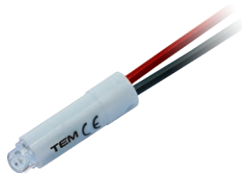

- IA20WH
- IA20GR
- IA20RD
- IA20BL

- zur Kontrollbeleuchtung, Beleuchtung oder ständige Beleuchtung des Schalters
  - in Kombination mit Wippe mit einem Indikator
- LED LAMP 230V AC/DC 0,40W*
- for indication, illumination or constant illumination of switch
  - in combination with button with indicator

**LED-LAMPE 24V AC/DC 0,20W**

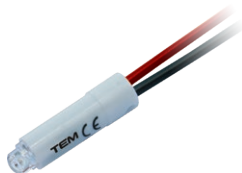

- IA21WH
- IA21RD

- zur Kontrollbeleuchtung, Beleuchtung oder ständige Beleuchtung des Schalters
  - in Kombination mit Wippe mit einem Indikator
- LED LAMP 24V AC/DC 0,20W*
- for indication, illumination or constant illumination of switch
  - in combination with button with indicator

**LED-LAMPE 12V AC/DC 0,10W**

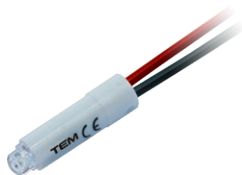

- IA22WH
- IA22RD

- zur Kontrollbeleuchtung, Beleuchtung oder ständige Beleuchtung des Schalters
  - in Kombination mit Wippe mit einem Indikator
- LED LAMP 12V AC/DC 0,10W*
- for indication, illumination or constant illumination of switch
  - in combination with button with indicator

\* Kontrollbeleuchtung /  
Indication

Beleuchtung /  
Illumination

\* Ständige Beleuchtung /  
Illumination always on

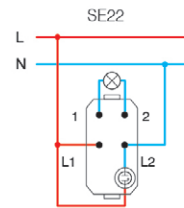
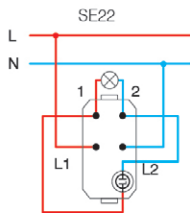
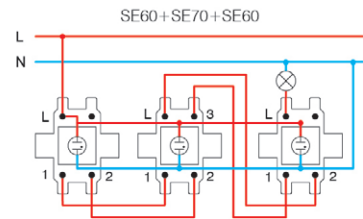
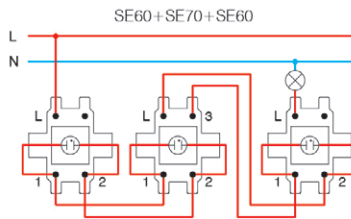
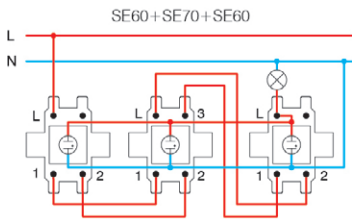
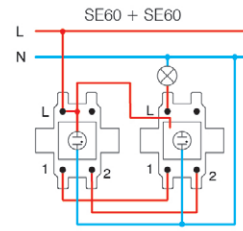
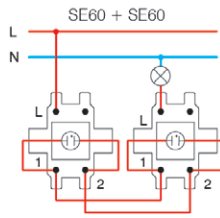
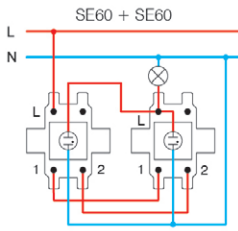
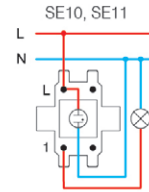
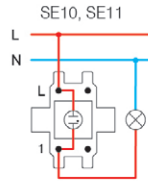
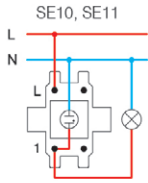

\* Schaltung geeignet für Sparlampen (CFL, LED) /  
wiring scheme for energy saving lamps (CFL, LED)

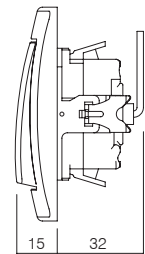

S O C K E T S V E



VE11



PT

XO

KS



Typ type	Bezeichnung description	Technische Daten technical data	Optionsbezeichnung 1 optional data 1	Optionsbezeichnung 2 optional data 2
VE10	STECKDOSE SCHUKO SOCKET SCHUKO	2P+E 16A 250V~	XO ohne Rahmen without cover plate	KS Steckdose mit erhöhtem Berührungsschutz shuttered live contacts
VE11	STECKDOSE SCHUKO+KLAPPDECKEL SOCKET SCHUKO+COVER	2P+E 16A 250V~		
VE12	STECKDOSE SCHUKO SOCKET SCHUKO	2P+E 16A 250V~ BV	KS Steckdose mit erhöhtem Berührungsschutz shuttered live contacts	
⋮	⋮	⋮		



Farbe  
colour

<input type="checkbox"/> PW weiß-glänzend polar white	<input checked="" type="checkbox"/> PT weiß + transparent white+transparent	<input type="checkbox"/> PP weiß + weiß white+white
<input checked="" type="checkbox"/> IW beige-glänzend ivory white	<input checked="" type="checkbox"/> IT beige + transparent ivory+transparent	<input checked="" type="checkbox"/> II beige + beige ivory+ivory
<input type="checkbox"/> ES silber-matt elox silver	<input checked="" type="checkbox"/> ST silber + transparent silver+transparent	<input type="checkbox"/> SS silber + silber silver+silver
<input type="checkbox"/> CO weiß, Duroplast white thermoset	<input type="checkbox"/> CT weiß + transparent white+transparent	<input checked="" type="checkbox"/> BB schwarz + schwarz black+black
<input checked="" type="checkbox"/> NB schwarz-glänzend night black	<input checked="" type="checkbox"/> BT schwarz + transparent black+transparent	<input checked="" type="checkbox"/> RR rot + rot red+red
<input checked="" type="checkbox"/> RD rot red	<input checked="" type="checkbox"/> RT rot + transparent red+transparent	<input checked="" type="checkbox"/> GG grün + grün green+green
<input checked="" type="checkbox"/> GR grün green	<input checked="" type="checkbox"/> GT grün + transparent green+transparent	<input checked="" type="checkbox"/> OO orange + orange orange+orange
<input checked="" type="checkbox"/> OR orange orange	<input checked="" type="checkbox"/> OT orange + transparent orange+transparent	



Schuko – entspricht EN 60884-1, CEE7 (Blatt III)

Französisch - entspricht NF C 61-314 (Blatt V)

schuko - in accordance with EN 60884-1, CEE7 (standard sheet III)

French - in accordance with NF C 61-314 (standard sheet V)

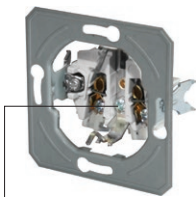

Schraubklemmen  
screw contacts

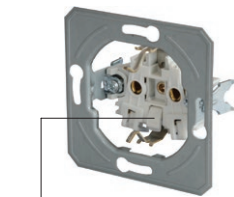

BV Steckklemmen  
BV plug-in contacts

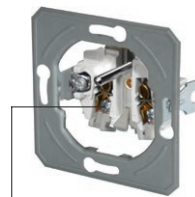

Schraubklemmen  
screw contacts

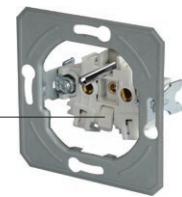

BV Steckklemmen  
BV plug-in contacts

STECKDOSE SCHUKO 2P+E 16A 250V~ \_\_ XO

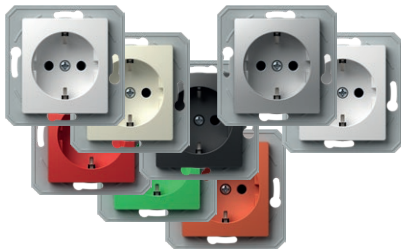

- VE10PWXO
- VE10IWXO
- VE10ESXO
- VE10COXO
- VE10NBXO
- VE10RDXO
- VE10GRXO
- VE10ORXO

- Schraubklemmen 1,5-2,5 mm<sup>2</sup>
- XO ohne Rahmen
- Steckdose mit Schutzkontakt
- 16A 250V~, Typ VE10

SOCKET SCHUKO 2P+E 16A 250V~ \_\_ XO

- screw contacts 1.5-2.5mm<sup>2</sup>
- XO without surround
- 2P+E schuko
- 16A 250V~, type VE10



STECKDOSE SCHUKO+DECKEL 2P+E 16A 250V~ \_\_ XO

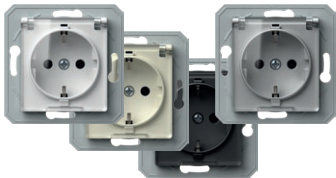

- VE11PTXO
- VE11ITXO
- VE11STXO
- VE11BTXO

- Schraubklemmen 1,5-2,5 mm<sup>2</sup>
- XO ohne Rahmen
- Steckdose mit Schutzkontakt mit Klappdeckel
- 16A 250V~, Typ VE11

SOCKET SCHUKO+COVER 2P+E 16A 250V~ \_\_ XO

- screw contacts 1.5-2.5mm<sup>2</sup>
- XO without surround
- 2P+E schuko+cover
- 16A 250V~, type VE11



STECKDOSE SCHUKO 2P+E 16A 250V~ BV\_XO



- VE12PWXO
- VE12IWXO
- VE12ESXO
- VE12COXO
- VE12NBXO
- VE12RDXO
- VE12GRXO
- VE12ORXO

- BV – Steckklemmen 1,5-2,5 mm<sup>2</sup>
- XO ohne Rahmen
- Steckdose mit Schutzkontakt
- 16A 250V~, Typ VE12

SOCKET SCHUKO 2P+E 16A 250V~ BV \_\_ XO

- BV plug-in contacts 1.5-2.5mm<sup>2</sup>
- XO without surround
- 2P+E schuko
- 16A 250V~, type VE12



STECKDOSE SCHUKO+KLAPPDECKEL 2P+E 16A 250V~ BV \_\_ XO

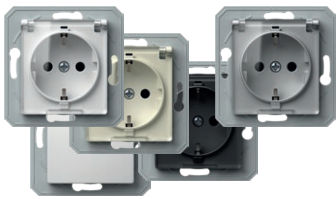

- VE13PTXO
- VE13ITXO
- VE13STXO
- VE13BTXO

- BV – Steckklemmen 1,5-2,5 mm<sup>2</sup>
- XO ohne Rahmen
- Steckdose mit Schutzkontakt mit Klappdeckel
- 16A 250V~, Typ VE13

SOCKET SCHUKO+COVER 2P+E 16A 250V~ BV \_\_ XO

- BV plug-in contacts 1.5-2.5mm<sup>2</sup>
- XO without surround
- 2P+E schuko+cover
- 16A 250V~, type VE13



STECKDOSE SCHUKO 2P+E 16A 250V~



- VE10PW
- VE10IW
- VE10ES
- VE10CO
- VE10NB

- Schraubklemmen 1,5-2,5 mm<sup>2</sup>
- Steckdose mit Schutzkontakt
- 16A 250V~, Typ VE10

SOCKET SCHUKO 2P+E 16A 250V~

- screw contacts 1.5-2.5mm<sup>2</sup>
- 2P+E schuko
- 16A 250V~, type VE10



STECKDOSE SCHUKO+KLAPPDECKEL 2P+E 16A 250V~

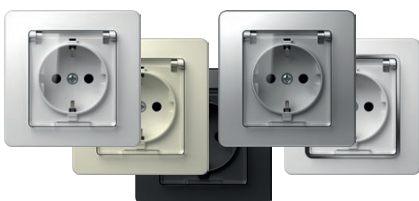

- VE11PT
- VE11IT
- VE11ST
- VE11CT
- VE11BT

- Schraubklemmen 1,5-2,5 mm<sup>2</sup>
- Steckdose mit Schutzkontakt mit Klappdeckel
- 16A 250V~, Typ VE11

SOCKET SCHUKO+COVER 2P+E 16A 250V~

- screw contacts 1.5-2.5mm<sup>2</sup>
- 2P+E schuko+cover
- 16A 250V~, type VE11



STECKDOSE SCHUKO 2P+E 16A 250V~ BV



- VE12PW
- VE12IW
- VE12ES
- VE12CO
- VE12NB

- BV – Steckklemmen 1,5-2,5 mm<sup>2</sup>
- Steckdose mit Schutzkontakt
- 16A 250V~, Typ VE12

SOCKET SCHUKO 2P+E 16A 250V~ BV

- BV plug-in contacts 1.5-2.5mm<sup>2</sup>
- 2P+E schuko
- 16A 250V~, type VE12



STECKDOSE SCHUKO+KLAPPDECKEL 2P+E 16A 250V~ BV



- VE13PT
- VE13IT
- VE13ST
- VE13CT
- VE13BT

- BV – Steckklemmen 1,5-2,5 mm<sup>2</sup>
- Steckdose mit Schutzkontakt mit Klappdeckel
- 16A 250V~, Typ VE13

SOCKET SCHUKO+COVER 2P+E 16A 250V~ BV

- BV plug-in contacts 1.5-2.5mm<sup>2</sup>
- 2P+E schuko+cover
- 16A 250V~, type VE13



## STECKDOSE FRANZÖSISCH 2P+E 16A 250V~ \_\_ XO



- VE40PWXO
- VE40IWXO
- VE40ESXO
- VE40COXO
- VE40NBXO
- VE40RDXO
- VE40GRXO
- VE40ORXO

- Schraubklemmen 1,5-2,5 mm<sup>2</sup>
- XO ohne Rahmen
- Steckdose mit Schutzkontakt, französischer Standard
- 16A 250V~, Typ VE40

## SOCKET FRENCH 2P+E 16A 250V~ \_\_ XO

- screw contacts 1.5-2.5mm<sup>2</sup>
- XO without surround
- 2P+E French
- 16A 250V~, type VE40



## STECKDOSE FRANZÖSISCH+KLAPPDECKEL 2P+E 16A 250V~ \_\_ XO

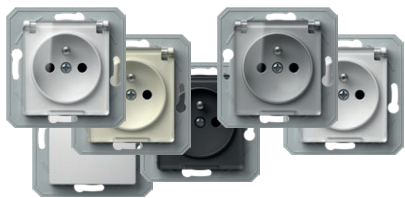

- VE41PTXO
- VE41ITXO
- VE41STXO
- VE41PTXO
- VE41BTXO
- VE41PPXO

- Schraubklemmen 1,5-2,5 mm<sup>2</sup>
- XO ohne Rahmen
- Steckdose mit Schutzkontakt mit Klappdeckel, französischer Standard
- 16A 250V~, Typ VE41

## SOCKET FRENCH+COVER 2P+E 16A 250V~ \_\_ XO

- screw contacts 1.5-2.5mm<sup>2</sup>
- XO without surround
- 2P+E French+cover
- 16A 250V~, type VE41



## STECKDOSE FRANZÖSISCH 2P+E 16A 250V~ BV \_\_ XO

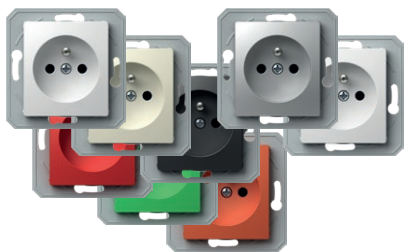

- VE42PWXO
- VE42IWXO
- VE42ESXO
- VE42COXO
- VE42NBXO
- VE42RDXO
- VE42GRXO
- VE42ORXO

- BV – Steckklemmen 1,5-2,5 mm<sup>2</sup>
- XO ohne Rahmen
- Steckdose mit Schutzkontakt, französischer Standard
- 16A 250V~, Typ VE42

## SOCKET FRENCH 2P+E 16A 250V~ BV \_\_ XO

- BV plug-in contacts 1.5-2.5mm<sup>2</sup>
- XO without surround
- 2P+E French
- 16A 250V~, type VE42



## STECKDOSE FRANZÖSISCH+KLAPPDECKEL 2P+E 16A 250V~ BV \_\_ XO

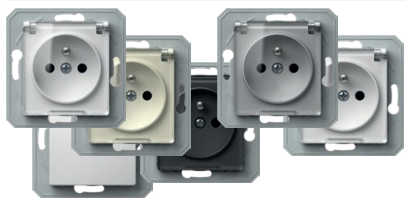

- VE43PTXO
- VE43ITXO
- VE43STXO
- VE43PTXO
- VE43BTXO
- VE43PPXO

- BV – Steckklemmen 1,5-2,5 mm<sup>2</sup>
- XO ohne Rahmen
- Steckdose mit Schutzkontakt mit Klappdeckel, französischer Standard
- 16A 250V~, Typ VE43

## SOCKET FRENCH+COVER 2P+E 16A 250V~ BV \_\_ XO

- BV plug-in contacts 1.5-2.5mm<sup>2</sup>
- XO without surround
- 2P+E French+cover
- 16A 250V~, type VE43



## STECKDOSE FRANZÖSISCH 2P+E 16A 250V~

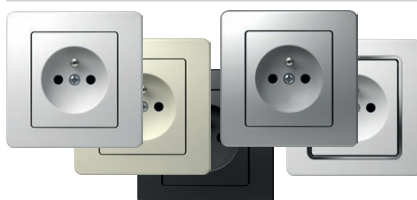

- VE40PW
- VE40IW
- VE40ES
- VE40CO
- VE40NB

- Schraubklemmen 1,5-2,5 mm<sup>2</sup>
- Steckdose mit Schutzkontakt, französischer Standard
- 16A 250V~, Typ VE40

## SOCKET FRENCH 2P+E 16A 250V~

- screw contacts 1.5-2.5mm<sup>2</sup>
- 2P+E French
- 16A 250V~, type VE40



## STECKDOSE FRANZÖSISCH+KLAPPDECKEL 2P+E 16A 250V~



- VE41PT
- VE41IT
- VE41ST
- VE41CT
- VE41BT

- Schraubklemmen 1,5-2,5 mm<sup>2</sup>
- Steckdose mit Schutzkontakt mit Klappdeckel, französischer Standard
- 16A 250V~, Typ VE41

## SOCKET FRENCH+COVER 2P+E 16A 250V~

- screw contacts 1.5-2.5mm<sup>2</sup>
- 2P+E French+cover
- 16A 250V~, type VE41



## STECKDOSE FRANZÖSISCH 2P+E 16A 250V~ BV



- VE42PW
- VE42IW
- VE42ES
- VE42CO
- VE42NB

- BV – Steckklemmen 1,5-2,5 mm<sup>2</sup>
- Steckdose mit Schutzkontakt, französischer Standard
- 16A 250V~, Typ VE42

## SOCKET FRENCH 2P+E 16A 250V~ BV

- BV plug-in contacts 1.5-2.5mm<sup>2</sup>
- 2P+E French
- 16A 250V~, type VE42



## STECKDOSE FRANZÖSISCH+KS+KLAPPDECKEL 2P+E 16A 250V~ BV



- VE43PT
- VE43IT
- VE43ST
- VE43CT
- VE43BT

- BV – Steckklemmen 1,5-2,5 mm<sup>2</sup>
- Steckdose mit Schutzkontakt mit Klappdeckel, französischer Standard
- 16A 250V~, Typ VE43

## SOCKET FRENCH+COVER 2P+E 16A 250V~ BV

- BV plug-in contacts 1.5-2.5mm<sup>2</sup>
- 2P+E French+cover
- 16A 250V~, type VE43



STECKDOSE SCHUKO DOPPELT 2P+E 16A 250V~



- VE16PWKS
- VE16IWKS
- VE16ESKS
- VE16NBKS

- Doppelsteckdose mit Schutzkontakt
- 16A 250V~, Typ VE16
- entspricht IEC 60884-1, CEE7
- Schraubklemmen 1,5-2.5 mm<sup>2</sup>
- KS mit erhöhtem Berührungsschutz

SOCKET SCHUKO DOUBLE 2P+E 16A 250V~

- 2P+E schuko double
- 16A 250V~, type VE16
- in accordance with IEC 60884-1, CEE7
- screw contacts 1.5-2.5 mm<sup>2</sup>
- KS shuttered live contacts



STECKDOSE FRANZÖSISCH DOPPELT 2P+E 16A 250V~



- VE46PWKS
- VE46IWKS
- VE46ESKS
- VE46NBKS

- Doppelsteckdose mit Schutzkontakt, französischer Standard
- 16A 250V~, Typ VE46
- entspricht IEC 60884-1, CEE7; NF C 61-314, CSN 33 2318; PN-E 93201
- Schraubklemmen 1,5-2.5 mm<sup>2</sup>
- KS mit erhöhtem Berührungsschutz

SOCKET FRENCH DOUBLE 2P+E 16A 250V~

- 2P+E French double
- 16A 250V~, type VE46
- in accordance with IEC 60884-1, CEE7; NF C 61-314, CSN 33 2318; PN-E 93201
- screw contacts 1.5-2.5 mm<sup>2</sup>
- KS shuttered live contacts



STECKDOSE 2P 16A 250V~



- VE30PW
- VE30IW
- VE30ES
- VE30NB

- 2P ohne Erdungskontakt
- 16A 250V~
- entspricht EN 60884-1, CEE7 (Seite I)
- Schraubklemmen 1,5-2,5 mm<sup>2</sup>

SOCKET 2P 16A 250V~

- 2P without earthing contact
- 16A 250V~
- in accordance with EN 60884-1, CEE7 (standard sheet I)
- screw contacts 1.5-2.5mm<sup>2</sup>

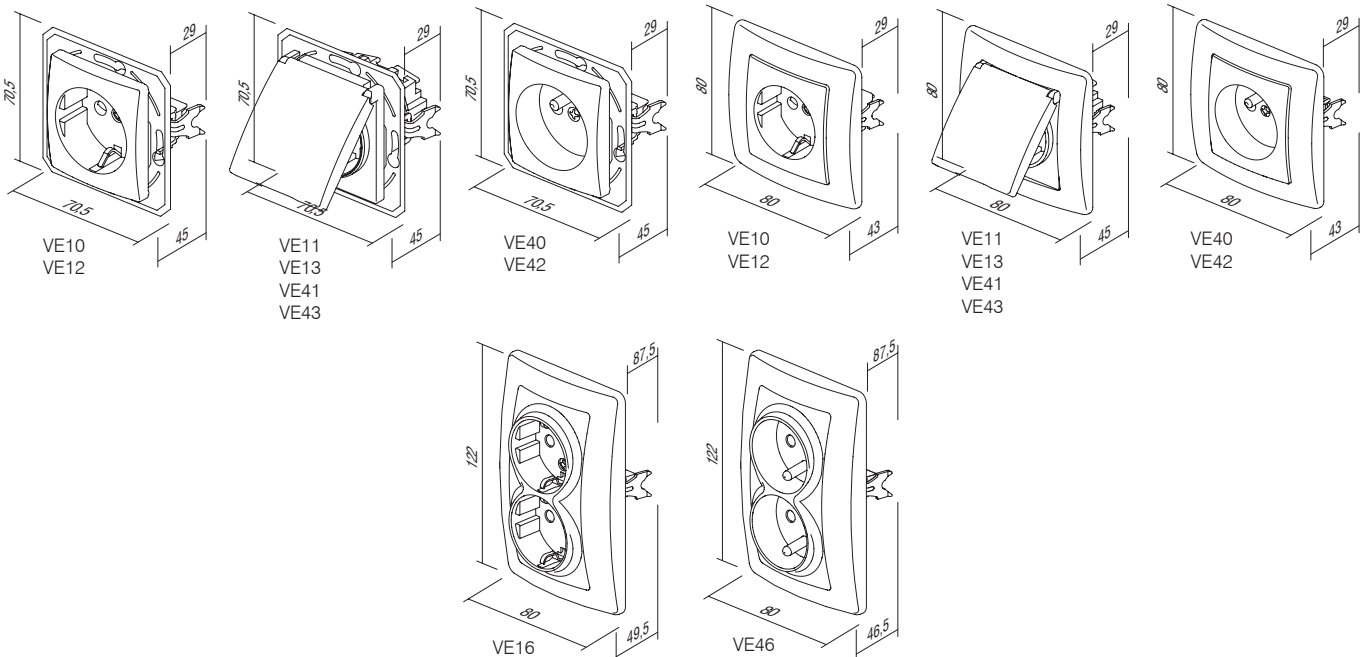



Typ type	Bezeichnung description	Technische Daten technical data	Farbe colour
KE11	STECKDOSE TV-R ENDDOSE SOCKET TV-R END-LINE	1dB	<input type="checkbox"/> PW weiß-glänzend polar white
KE12	STECKDOSE TV-R DURCHGANGSDOSE SOCKET TV-R THROUGHPASS	10dB	<input type="checkbox"/> IW beige-glänzend ivory white
KE16	STECKDOSE SAT-TV-R ENDDOSE SOCKET SAT-TV-R END-LINE	3dB	<input type="checkbox"/> ES silber-matt elox silver
⋮	⋮	⋮	<input type="checkbox"/> CO weiß, Duroplast white thermoset
⋮	⋮	⋮	<input type="checkbox"/> NB schwarz-glänzend night black

**STECKDOSE TV-R-ENDDOSE 1dB**



KE11

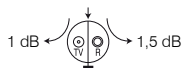

- TV-R-Enddose
- Übertragungsbandbreite 5=862 MHz
- Dämpfung: R-1,5 dB, TV-1 dB
- entspricht EN 50083-1
- Schraubklemmen

**SOCKET TV-R END-LINE 1dB**

- TV-R end-line
- frequency range 5=862MHz
- reduction: R-1.5dB, TV-1dB
- in accordance with EN 50083-1
- screw contacts

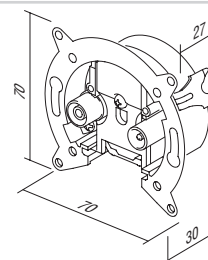

**STECKDOSE TV-R-DURCHGANGSDOSE 10dB**



KE12

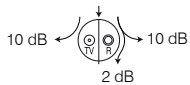

- TV-R Durchgangsdose
- Übertragungsbandbreite 5=862 MHz
- Dämpfung: R-10 dB, TV-10 dB, Durchgang-2 dB
- entspricht EN 50083-1
- Schraubklemmen

**SOCKET TV-R TROUGHPASS 10dB**

- TV-R troughpass
- frequency range 5=862MHz
- reduction: R-10dB, TV-10dB, trough-2dB
- in accordance with EN 50083-1
- screw contacts

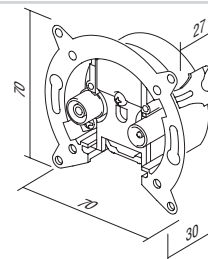

**STECKDOSE SAT-TV-R-ENDDOSE 3dB**



KE16

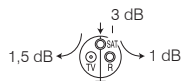

- SAT-TV-R-Enddose
- Übertragungsbandbreite 5=2400 MHz
- Dämpfung: R-1 dB, TV-1,5 dB, SAT-3 dB
- Montage in der Wanddose Ø60 mit Krallen oder Schrauben
- entspricht EN 50083-1
- Schraubklemmen

**SOCKET SAT-TV-R END-LINE 3dB**

- SAT-TV-R end-line
- frequency range 5=2400MHz
- reduction: R-1dB, TV-1.5dB, SAT-3dB
- for mounting in round box Ø60 with claws or screws
- in accordance with EN 50083-1
- screw contacts

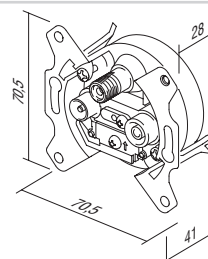

**STECKDOSE TEL KS RJ11 6/4**



KE36

- KS – keystone-Befestigungsstandard
- RJ11 6/4
- entspricht IEC 60603-7

**SOCKET TEL KS RJ11 6/4**

- KS keystone fixing standard
- RJ11 6/4
- in accordance with IEC 60603-7

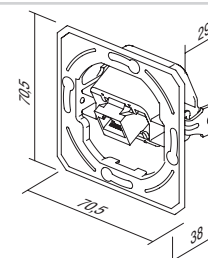



KE37

**STECKDOSE CAT5e KS RJ45 8/8**

- KS – keystone-Befestigungsstandard
- CAT5e, RJ45 8/8
- entspricht IEC 60603-7

*SOCKET CAT5e KS RJ45 8/8*

- KS keystone fixing standard
- CAT5e, RJ45 8/8
- in accordance with IEC 60603-7

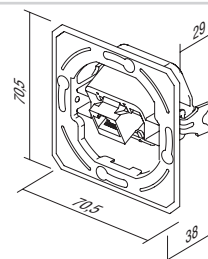

KE40

**STECKDOSE CAT6s KS RJ45 8/8 SLIM**

- KS – keystone-Befestigungsstandard
- CAT6s, RJ45 8/8
- entspricht IEC 60603-7

*SOCKET CAT6s KS RJ45 8/8 SLIM*

- KS keystone fixing standard
- CAT6s, RJ45 8/8
- in accordance with IEC 60603-7

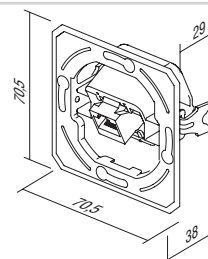

KE38

**STECKDOSE TEL KS DOPPELT 2x RJ11 6/4**

- KS – keystone-Befestigungsstandard
- 2x RJ11 6/4
- entspricht IEC 60603-7

*SOCKET TEL KS DOUBLE 2x RJ11 6/4*

- KS keystone fixing standard
- 2x RJ11 6/4
- in accordance with IEC 60603-7

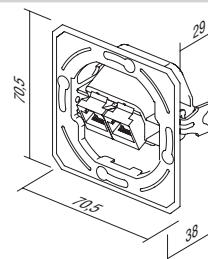

KE39

**STECKDOSE CAT5e KS DOPPELT 2x RJ45 8/8**

- KS – keystone-Befestigungsstandard
- 2x CAT5e, RJ45 8/8
- entspricht IEC 60603-7

*SOCKET CAT5e KS DOUBLE 2x RJ45 8/8*

- KS keystone fixing standard
- 2x CAT5e, RJ45 8/8
- in accordance with IEC 60603-7

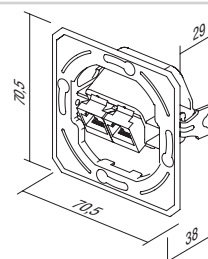

KE41

**STECKDOSE CAT6s KS DOPPELT 2x RJ45 8/8 SLIM**

- KS – keystone-Befestigungsstandard
- 2x CAT6s, RJ45 8/8
- entspricht IEC 60603-7

*SOCKET CAT6s KS DOUBLE 2x RJ45 8/8 SLIM*

- KS keystone fixing standard
- 2x CAT6s, RJ45 8/8
- in accordance with IEC 60603-7

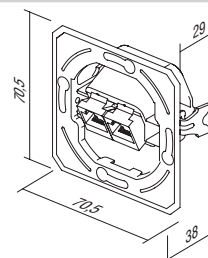

KE45

**ADAPTER KS EINFACH**

- KS – keystone-Befestigungsstandard – einfach
- AMP, Avaya, Brandrex, FMT, Mfico, Tyco, ...
- ohne Kommunikationsmodul

*ADAPTER KS SINGLE*

- KS keystone fixing standard - single
- AMP, Avaya, Brandrex, FMT, Mfico, Tyco, ...
- communication module not included

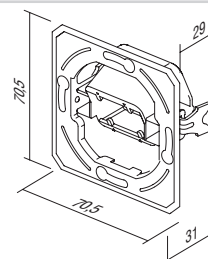





KE46

**ADAPTER KS DOPPELT**

- KS – keystone-Befestigungsstandard – doppelt
- AMP, Tyco, ...
- ohne Kommunikationsmodul

**ADAPTER KS DOUBLE**

- KS keystone fixing standard - double
- AMP, Tyco, ...
- communication module not included

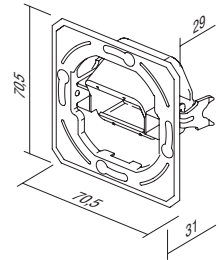

KE47

**ADAPTER PD DOPPELT**

- PD Panduit MiniCOM-Befestigungsstandard – doppelt
- ohne Kommunikationsmodul

**ADAPTER PD DOUBLE**

- PD Panduit Mini-COM fixing standard - double
- communication module not included

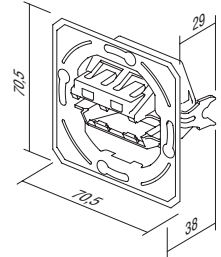

STECKDOSE TV-EINZELDOSE 0dB



- KE10PW
- KE10IW
- KE10ES
- KE10CO
- KE10NB

- TV-Einzeldose
- Dämpfung 0 dB
- Rückanschluss – F-Standard

SOCKET TV BASIC 0dB

- TV basic
- reduction 0dB
- back connector – F standard



STECKDOSE TV-R-ENDDOSE 1dB



- KE11PW
- KE11IW
- KE11ES
- KE11CO
- KE11NB

- TV-R-Enddose
- Übertragungsbandbreite 5÷862 MHz
- Dämpfung: R-1,5 dB, TV-1 dB
- entspricht EN 50083-1
- Schraubklemmen

SOCKET TV-R END-LINE 1dB

- TV-R end-line
- frequency range 5÷862 MHz
- reduction: R-1.5dB, TV-1dB
- in accordance with EN 50083-1
- screw contact



STECKDOSE TV-R-DURCHGANGSDOSE 10dB



- KE12PW
- KE12IW
- KE12ES
- KE12CO
- KE12NB

- TV-R-Durchgangsdose
- Übertragungsbandbreite 5÷862 MHz
- Dämpfung: R-10 dB, TV-10 dB, Durchgang-2 dB
- entspricht EN 50083-1
- Schraubklemmen

SOCKET TV-R TROUGH-PASS 10dB

- TV-R troughpass
- frequency range 5÷862 MHz
- reduction: R-10dB, TV-10dB, trough-2dB
- in accordance with EN 50083-1
- screw contacts



STECKDOSE SAT-TV-R-ENDDOSE 3dB



- KE16PW
- KE16IW
- KE16ES
- KE16CO
- KE16NB

- SAT-TV-R-Enddose
- Übertragungsbandbreite 5÷2400 MHz
- Dämpfung: R-1 dB, TV-1,5 dB, SAT-3 dB
- entspricht EN 50083-1
- Schraubklemmen

SOCKET SAT-TV-R END-LINE 3dB

- SAT-TV-R end-line
- frequency range 5÷2400 MHz
- reduction: R-1dB, TV-1.5dB, SAT-3dB
- in accordance with EN 50083-1
- screw contacts



STECKDOSE AUDIO 2xRCA



- KE22PW
- KE22IW
- KE22ES
- KE22CO
- KE22NB

- Audio 2xRCA
- geloteter Kabelanschluss

SOCKET AUDIO 2xRCA

- audio 2xRCA
- soldering connection of cable



STECKDOSE AUDIO FÜR LAUTSPRECHER



- KE23PW
- KE23IW
- KE23ES
- KE23CO
- KE23NB

- Audio-Anschlussdose – 2x Ø4 mm
- Kabelanschluss für Lautsprecher, Stecker Ø4 mm oder Gabel-Kabelstecker
- gelöteter Kabelanschluss hinten

SOCKET AUDIO LOUDSPEAKERS

- audio 2x Ø4mm
- to accommodate speaker wire, banana plug Ø4mm or spades
- soldering connection of cable at the back side



STECKDOSE TEL KS RJ11 6/4

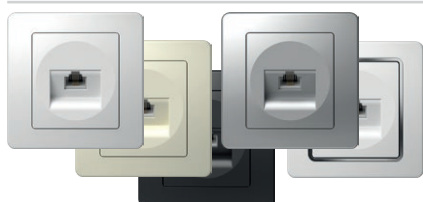

- KE36PW
- KE36IW
- KE36ES
- KE36CO
- KE36NB

- KS – keystone-Befestigungsstandard
- RJ11 6/4
- entspricht IEC 60603-7

SOCKET TEL KS RJ11 6/4

- KS keystone fixing standard
- RJ11 6/4
- in accordance with IEC 60603-7



**STECKDOSE CAT5e KS RJ45 8/8**

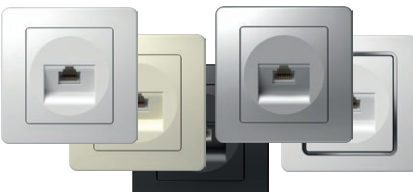

- KE37PW
- KE37IW
- KE37ES
- KE37CO
- KE37NB

- KS – keystone-Befestigungsstandard
- CAT5e, RJ45 8/8
- entspricht IEC 60603-7

*SOCKET CAT5e KS RJ45 8/8*

- KS keystone fixing standard
- CAT5e, RJ45 8/8
- in accordance with IEC 60603-7



**STECKDOSE CAT6s KS RJ45 8/8 SLIM**

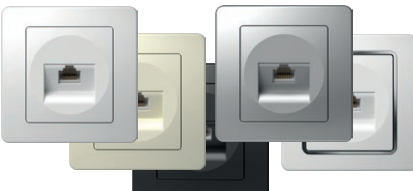

- KE40PW
- KE40IW
- KE40ES
- KE40CO
- KE40NB

- KS – keystone-Befestigungsstandard
- CAT6s, RJ45 8/8
- entspricht IEC 60603-7

*SOCKET CAT6s KS RJ45 8/8 SLIM*

- KS keystone fixing standard
- CAT6s, RJ45 8/8
- in accordance with IEC 60603-7



**STECKDOSE TEL KS DOPPELT 2x RJ11 6/4**

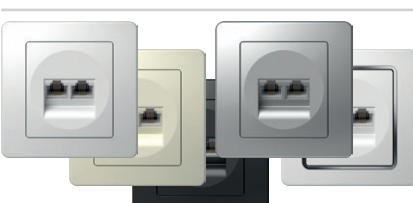

- KE38PW
- KE38IW
- KE38ES
- KE38CO
- KE38NB

- KS – keystone-Befestigungsstandard
- 2x RJ11 6/4
- entspricht IEC 60603-7

*SOCKET TEL KS DOUBLE 2x RJ11 6/4*

- KS keystone fixing standard
- 2x RJ11, 6/4
- in accordance with IEC 60603-7



**STECKDOSE CAT5e KS DOPPELT 2x RJ45 8/8**

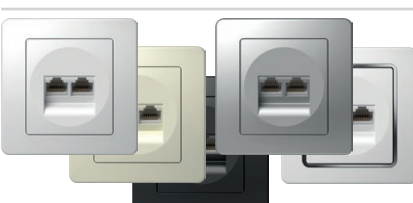

- KE39PW
- KE39IW
- KE39ES
- KE39CO
- KE39NB

- KS – keystone-Befestigungsstandard
- 2x CAT5e, RJ45 8/8
- entspricht IEC 60603-7

*SOCKET CAT5e KS DOUBLE 2x RJ45 8/8*

- KS keystone fixing standard
- 2x CAT5e, RJ45 8/8
- in accordance with IEC 60603-7



**STECKDOSE CAT6s KS DOPPELT 2x RJ45 8/8 SLIM**



- KE41PW
- KE41IW
- KE41ES
- KE41CO
- KE41NB

- KS – keystone-Befestigungsstandard
- 2x CAT6s, RJ45 8/8
- entspricht IEC 60603-7

*SOCKET CAT6s KS DOUBLE 2x RJ45 8/8 SLIM*

- KS keystone fixing standard
- 2x CAT6s, RJ45 8/8
- in accordance with IEC 60603-7



**STECKDOSE TEL LT RJ11 6/4**

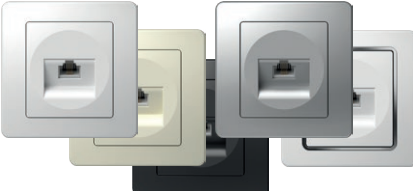

- KE35PW
- KE35IW
- KE35ES
- KE35CO
- KE35NB

- TEL LT mit Schraubklemmen
- Schraubklemmen
- RJ11 6/4
- entspricht IEC 60603-7

*SOCKET TEL LT RJ11 6/4*

- TEL LT screw
- screw contacts
- RJ11 6/4
- in accordance with IEC 60603-7

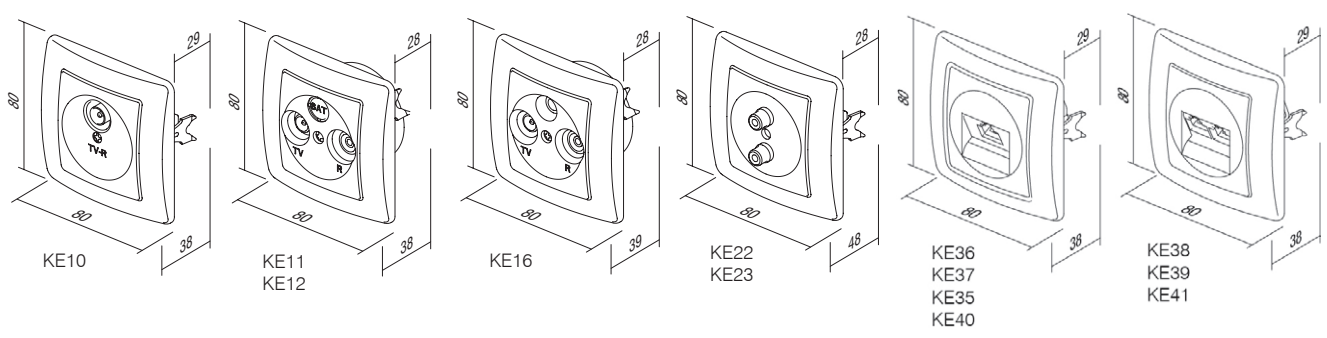

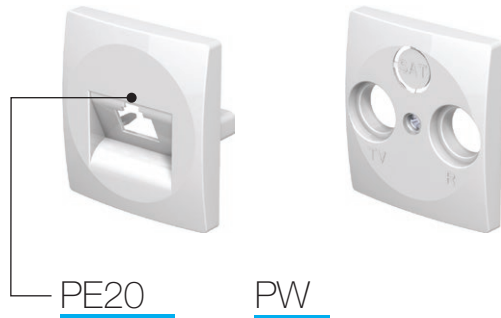

# DECKEL KOMMUNIKATION KE

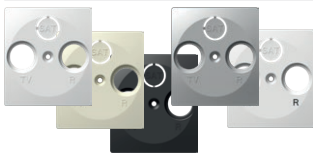

Typ type	Bezeichnung description	Technische Daten technical data	Farbe colour
PE10	DECKEL TV-R COVER TV-R	2P/3P	<input type="checkbox"/> PW weiß-glänzend polar white
PE20	DECKEL KS EINFACH COVER KS SINGLE		<input type="checkbox"/> IW beige-glänzend ivory white
PE21	DECKEL KS DOPPELT COVER KS DOUBLE		<input type="checkbox"/> ES silber-matt elox silver
⋮	⋮	⋮	<input type="checkbox"/> CO weiß, Duroplast white thermoset
			<input type="checkbox"/> NB schwarz-glänzend night black

## DECKEL TV-R 2P/3P



- PE10PW
- PE10IW
- PE10ES
- PE10CO
- PE10NB

- TV-R-Deckel, 2P oder 3P mit Schraube  
COVER TV-R 2P/3P  
- TV-R cover, 2P or 3P with screw



## DECKEL KS EINFACH



- PE20PW
- PE20IW
- PE20ES
- PE20CO
- PE20NB

- KS-Deckel einfach  
COVER KS SINGLE  
- KS cover single



## DECKEL KS DOPPELT

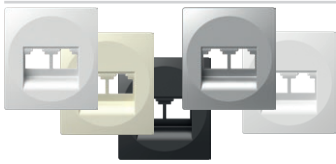

- PE21PW
- PE21IW
- PE21ES
- PE21NB

- KS-Deckel doppelt  
COVER KS DOUBLE  
- KS cover double



## DECKEL TAE/TDO



- PE30PW
- PE30IW
- PE30ES
- PE30NB

- TAE- oder TDO-Deckel mit Schraube  
COVER TAE/TDO  
- TAE or TDO cover with screw



## DECKEL IR-BEWEGUNGSMELDER



- PE32PW
- PE32IW
- PE32ES
- PE32NB

- deckel IR-bewegungsmelder  
COVER IR SWITCH  
- cover IR switch

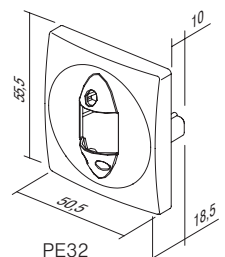
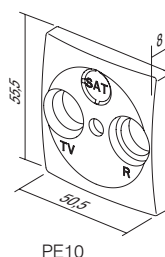
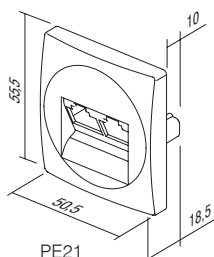
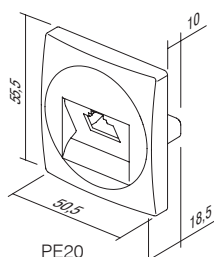
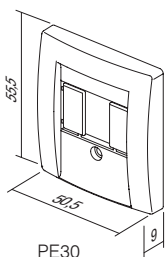

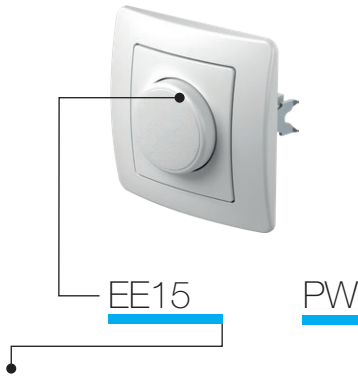

Typ type	Bezeichnung description	Technische Daten technical data	Farbe colour
EE15	DIMMER DREH-WECHSEL DIMMER ROTATIVE 2WAY	RL 400W	<input type="checkbox"/> PW weiß-glänzend polar white
EE16	DIMMER DREH-WECHSEL DIMMER ROTATIVE 2WAY	RLC 400W	<input type="checkbox"/> IW beige-glänzend ivory white
EE19	DIMMER DREH-WECHSEL DIMMER ROTATIVE 2WAY	LED 100W	<input type="checkbox"/> ES silber-matt elox silver
⋮	⋮	⋮	<input type="checkbox"/> CO weiß, Duroplast white thermoset
⋮	⋮	⋮	<input type="checkbox"/> NB schwarz-glänzend night black



EE15

**DIMMER DREH-WECHSEL RL 400W**

- Dreh-Wechsel
- Belastung RL, 40–400 W
- kann mit Wechselschalter verbunden werden
- Verbindung von zwei Dimmern ist nicht gestattet
- entspricht EN 60669-1 und EN 60669-2-1
- Schraubklemmen 1,5 mm<sup>2</sup>
- Versorgung 230 V<sup>~</sup> 50 Hz
- Durchmesser Knopf Ø6 mm
- inkl. Sicherung auswechselbar

*DIMMER ROTATIVE 2WAY RL 400W*

- rotation control with 2-way switch
- load RL, 40W - 400W
- 2-way switch combination is possible
- more dimmers combination is not allowed
- in accordance with EN 60669-1 and EN 60669-2-1
- plug-in contacts 1.5mm<sup>2</sup>
- supply 230V<sup>~</sup> 50Hz
- button inner diameter Ø6mm
- replaceable fuse included



EE16

**DIMMER DREH-WECHSEL RLC 400W**

- Dreh-Wechsel
- Belastung RL, 20–400 W
- kann mit Wechselschalter verbunden werden
- Verbindung von zwei Dimmern ist nicht gestattet
- entspricht EN 60669-1 und EN 60669-2-1
- Schraubklemmen 1,5 mm<sup>2</sup>
- Versorgung 230 V<sup>~</sup> 50 Hz
- Durchmesser Knopf Ø6 mm
- Elektroniksicherung

*DIMMER ROTATIVE 2WAY RLC 400W*

- rotation control with 2-way switch
- load RLC, 20W - 400W
- 2-way switch combination is possible
- more dimmers combination is not allowed
- in accordance with EN 60669-1 and EN 60669-2-1
- plug-in contacts 1.5mm<sup>2</sup>
- supply 230V<sup>~</sup> 50Hz
- button inner diameter Ø6mm
- electronic fuse



EE19

**DIMMER DREH-WECHSEL LED 100W**

- Dreh-Wechsel
- Belastung: LED, 0–100 W (max. 10 LED-Lampen)  
GLS, 10–250 W
- kann mit Wechselschalter verbunden werden
- Verbindung von zwei Dimmern ist nicht gestattet
- entspricht EN 60669-1 und EN 60669-2-1
- Schraubklemmen 1,5 mm<sup>2</sup>
- Versorgung 230 V<sup>~</sup> 50 Hz
- inkl. Sicherung auswechselbar
- Durchmesser Knopf Ø6 mm

*DIMMER ROTATIVE 2WAY LED 100W*

- rotation control with 2-way switch
- load: LED, 0-100W (max. 10 LEDs)  
GLS, 10-250W
- 2-way switch combination is possible
- more dimmers combination is not allowed
- in accordance with EN 60669-1 and EN 60669-2-1
- plug-in contacts 1.5mm<sup>2</sup>
- supply 230V<sup>~</sup> 50Hz
- replaceable fuse included
- button inner diameter Ø6mm

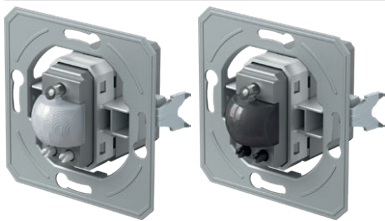

- EE32A1
- EE32A2

**IR SCHALTER 5A 230V~**

- IR-Schalter
- Versorgung: 230V<sup>~</sup> ±10 % 50Hz
- Relais: 5A / 250V<sup>~</sup> Ausgang mit hochohmigen Strombegrenzung für den Nulldurchgang
- Schutzart: IP40
- Schraubklemmen: 0,75–2,5 mm<sup>2</sup>
- Erfassungswinkel: bis 110° bei 20°C
- Erfassungsbereich: ca. 8 m bei 20°C
- Einstellung der Beleuchtungszeit: von ca. 5 s bis 12 min
- Beleuchtungseinstellung: von ca. 5 bis 200 Lx
- Betriebstemperatur: von 0°C bis +40°C
- nicht geeignet für den Einbau in Dosen mit Tiefe 45 mm
- nur für Gebrauch im Innenbereich

*IR SWITCH 5A 230V~*

- IR infrared switch
- supply voltage: 230V<sup>~</sup> ±10 % 50Hz
- relay: 5A / 250V<sup>~</sup> output for limited current with high resistance for zero crossing
- protection rating: IP40
- cross-section of wires at the contact terminal: 0.75 - 2.5 mm<sup>2</sup>
- detection angle: up to 110° at 20°C
- detection area: approx. 8 m at 20°C
- adjustability of duration: from approx. 5 s to 12 min
- adjustability of brightness: from approx. 5 to 200 LUX
- operating temperature: from 0°C to +40°C
- not suitable for installation in 45 mm deep boxes
- only for indoor usage



- EE15PW
- EE15IW
- EE15ES
- EE15CO
- EE15NB

**DIMMER DREH-WECHSEL RL 400W**

- Dreh-Wechsel
- Belastung RL, 40 W – 400 W
- kann mit Wechselschalter verbunden werden
- Verbindung von zwei Dimmern ist nicht gestattet
- entspricht EN 60669-1 und EN 60669-2-1
- Schraubklemmen 1,5 mm<sup>2</sup>
- Versorgung 230 V<sup>~</sup> 50 Hz
- inkl. Sicherung auswechselbar

*DIMMER ROTATIVE 2WAY RL 400W*

- rotation control with 2-way switch
- load RL, 40W - 400W
- 2-way switch combination is possible
- more dimmers combination is not allowed
- in accordance with EN 60669-1 and EN 60669-2-1
- plug-in contacts 1.5mm<sup>2</sup>
- supply 230V<sup>~</sup> 50Hz
- replaceable fuse included



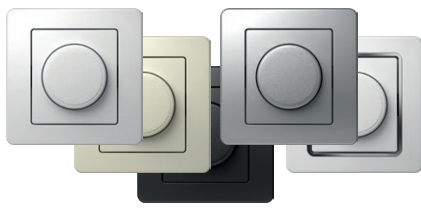

- EE16PW
- EE16IW
- EE16ES
- EE16CO
- EE16NB

#### DIMMER DREH-WECHSEL RLC 400W

- Dreh-Wechsel
- Belastung RL, 20 W – 400 W
- kann mit Wechselschalter verbunden werden
- Verbindung von zwei Dimmern ist nicht gestattet
- entspricht EN 60669-1 und EN 60669-2-1
- Schraubklemmen 1,5 mm<sup>2</sup>
- Versorgung 230 V~ 50 Hz
- Elektroniksicherung



#### DIMMER ROTATIVE 2WAY RLC 400W

- rotation control with 2-way switch
- load RLC, 20W - 400W
- 2-way switch combination is possible
- more dimmers combination is not allowed
- in accordance with EN 60669-1 and EN 60669-2-1
- plug-in contacts 1.5mm<sup>2</sup>
- supply 230V~ 50Hz
- electronic fuse

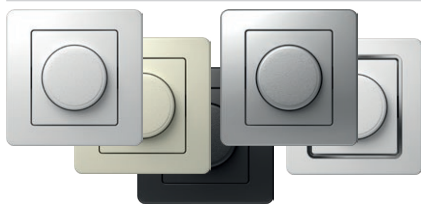

- EE19PW
- EE19IW
- EE19ES
- EE19CO
- EE19NB

#### DIMMER DREH-WECHSEL LED 100W

- Dreh-Wechsel
- Belastung: LED, 0-100 W (max. 10 LED-Lampen)
- GLS, 10-250 W
- kann mit Wechselschalter verbunden werden
- Verbindung von zwei Dimmern ist nicht gestattet
- entspricht EN 60669-1 und EN 60669-2-1
- Schraubklemmen 1,5 mm<sup>2</sup>
- Versorgung 230 V~ 50 Hz
- inkl. Sicherung auswechselbar



#### DIMMER ROTATIVE 2WAY LED 100W

- rotation control with 2-way switch
- load: LED, 0-100W (max. 10 LEDs)
- GLS, 10-250W
- 2-way switch combination is possible
- more dimmers combination is not allowed
- in accordance with EN 60669-1 and EN 60669-2-1
- plug-in contacts 1.5mm<sup>2</sup>
- supply 230V~ 50Hz
- replaceable fuse included



- EE32PW
- EE32IW
- EE32ES
- EE32CO
- EE32NB

#### IR SCHALTER 5A 230V~

- IR-Schalter
- Versorgung: 230V~ ±10 % 50Hz
- Relais: 5A / 250V~ Ausgang mit
- hochohmigen Strombegrenzung
- für den Nulldurchgang
- Schutzart: IP40
- Schraubklemmen: 0,75–2,5 mm<sup>2</sup>
- Erfassungswinkel: bis 110° bei 20°C
- Erfassungsbereich: ca. 8 m bei 20°C
- Einstellung der Beleuchtungszeit: von ca. 5 s bis 12 min
- Beleuchtungseinstellung: von ca. 5 bis 200 Lx
- Betriebstemperatur: von 0°C bis +40°C
- nicht geeignet für den Einbau in Dosen mit Tiefe 45 mm
- nur für Gebrauch im Innenbereich



#### IR SWITCH 5A 230V~

- IR infrared switch
- supply voltage: 230V~ ±10 % 50Hz
- relay: 5A / 250V~ output for limited current with
- high resistance for zero crossing
- protection rating: IP40
- cross-section of wires at the contact
- terminal: 0.75 - 2.5 mm<sup>2</sup>
- detection angle: up to 110° at 20°C
- detection area: approx. 8 m at 20°C
- adjustability of duration: from approx. 5 s to 12 min
- adjustability of brightness: from approx. 5 to 200 LUX
- operating temperature: from 0°C to +40°C
- not suitable for installation in 45 mm deep boxes
- only for indoor usage

EE15, EE16, EE19

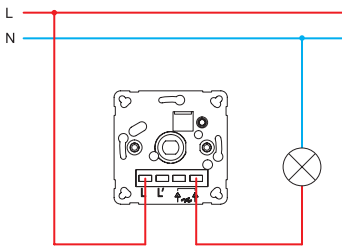

EE15, EE16, EE19

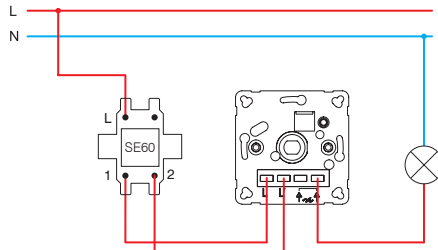

EE15, EE16, EE19

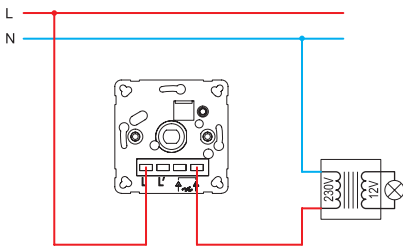

EE15, EE16, EE19

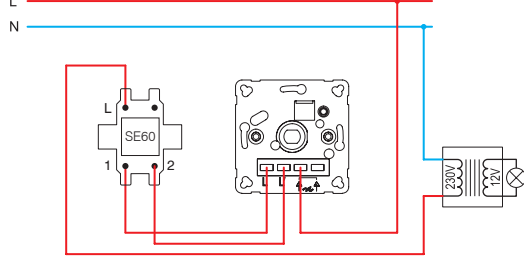

EE16, EE19

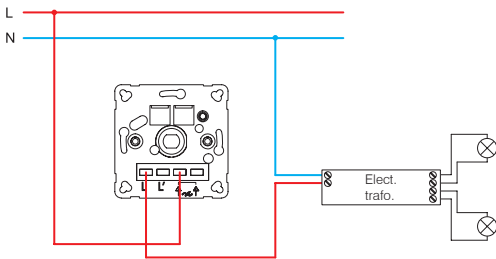

EE16, EE19

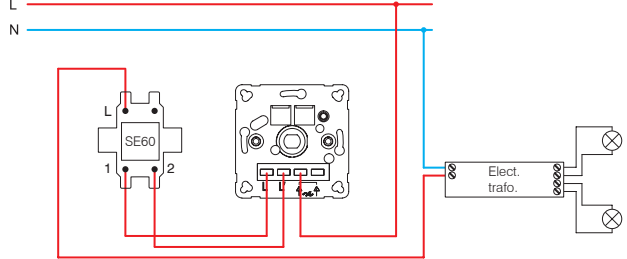

**EE15 (40÷400W)**

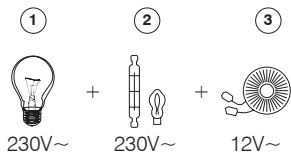

- 1 – Glühlampe / incandescent lamp
- 2 – Halogenlampe / halogen lamp

**EE16 (20÷400W)**

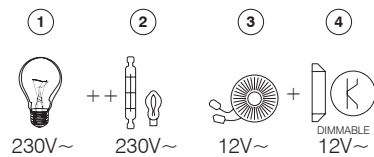

- 3 – klassischer Transformator / classical transformer
- 4 – dimmbarer elektronischer Transformator / dimmable electronic transformer
- 5 – dimmbare LED-Lampe / dimmable LED lamp

**EE19 (GLS 10÷250W ; LED 0÷100W)**

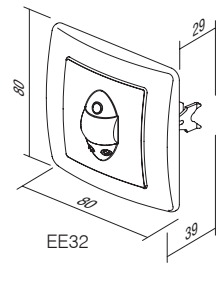
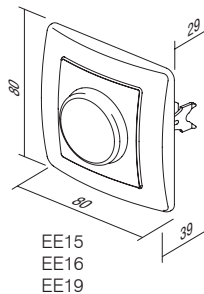
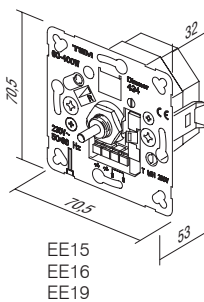
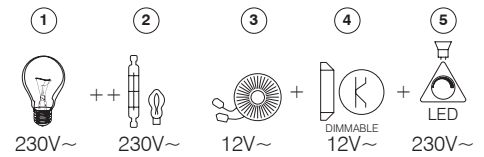



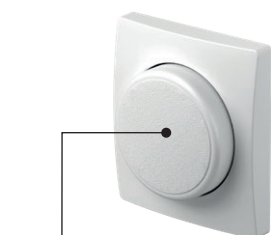

PE41

PW

Typ type	Bezeichnung description	Farbe colour
PE41	DECKEL FÜR DIMMER COVER DIMMER	<input type="checkbox"/> PW weiß-glänzend <i>polar white</i> <input type="checkbox"/> IW beige-glänzend <i>ivory white</i> <input type="checkbox"/> ES silber-matt <i>elox silver</i> <input type="checkbox"/> CO weiß, Duroplast <i>white thermoset</i> <input type="checkbox"/> NB schwarz-glänzend <i>night black</i>



- PE41PW
- PE41IW
- PE41ES
- PE41CO
- PE41NB

## DECKEL FÜR DIMMER Ø6

- Deckel für Dimmer Ø6 mm
- für EE15, EE16, EE19

## COVER DIMMER Ø6

- cover dimmer Ø6mm
- for EE15, EE16, EE19

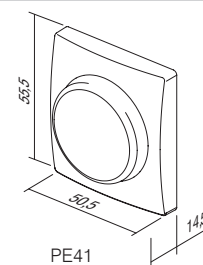

PE41

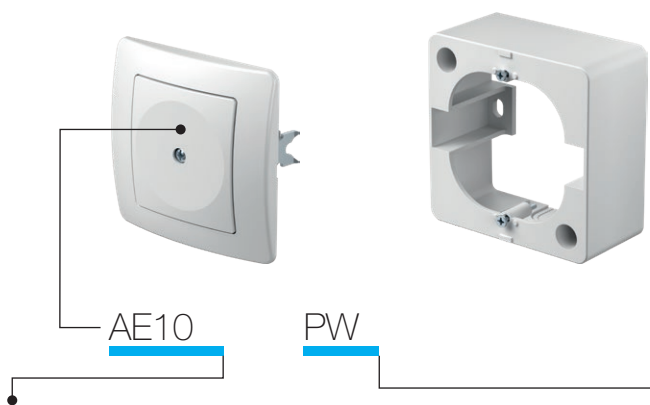

Typ type	Bezeichnung description	Farbe colour
AE10	BLLENDE BLANK	<input type="checkbox"/> PW weiß-glänzend polar white
AE20	HERDANSCHLUßDOSE 3P+N+E 5x4 mm <sup>2</sup> CONNECTION BOX 3P+N+E 5X4mm <sup>2</sup>	<input type="checkbox"/> IW beige-glänzend ivory white
AE30	AUFPUTZGEHÄUSE NO 1 SURFACE MOUNT BOX	<input type="checkbox"/> ES silber-matt elox silver
·	·	<input type="checkbox"/> CO weiß, Duroplast white thermoset
·	·	<input type="checkbox"/> NB schwarz-glänzend night black

**BLLENDE**



- AE10PW
- AE10IW
- AE10ES
- AE10CO
- AE10NB

- zum Abdecken von leeren Öffnungen

**BLANK**

- for filling up empty spaces



**HERDANSCHLUßDOSE 3P+N+E 5x4 mm<sup>2</sup>**



- AE20PW
- AE20IW

- 3P+N+E-Anschluss  
- 16A 400V  
- entspricht VDE 0601-1:2000  
- Schraubklemmen 1,5-4 mm<sup>2</sup>

**CONNECTION BOX 5POLE 3P+N+E 5x4mm<sup>2</sup>**

- 3P+N+E connection box  
- 16A 400V  
- in accordance with VDE 0606-1:2000  
- screw contacts 1.5-4mm<sup>2</sup>



**AUFPUTZGEHÄUSE 1**

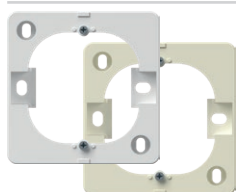

- AE30PW
- AE30IW

- Aufputzgehäuse

**SURFACE MOUNT BOX 1**

- surface mounting box



**AUFPUTZGEHÄUSE DOPPELSTECKDOSE**

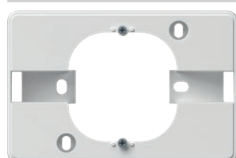

- AE31PW

- Aufputzgehäuse

**SURFACE MOUNT BOX FOR**

**EKONOMIK DOUBLE SOCKET**

- surface mounting box



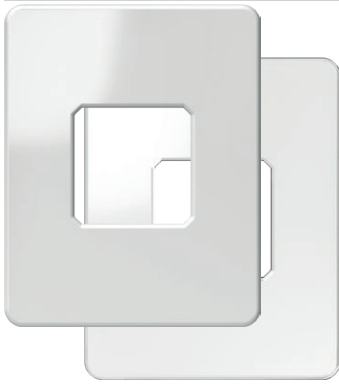

- AE50PW
- AE50TS

**TAPETENSCHUTZ**

- Dekor-Tapetenschutz für Schalter oder Steckdosen

**WALL PROTECTION**

- protects surface around socket or switch

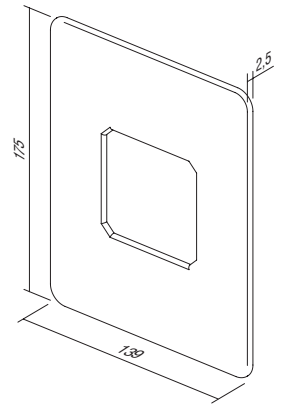

- AE51PW
- AE51IW

**KINDERSCHUTZ KS**

- KS-Kinderschutz gegen Berührung stromführender Teile

**CHILD PROTECTION KS**

- KS additional child protection insert - shuttered live contacts

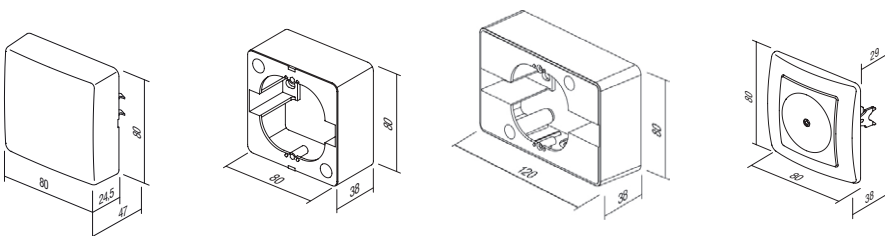
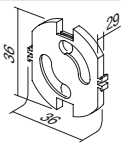

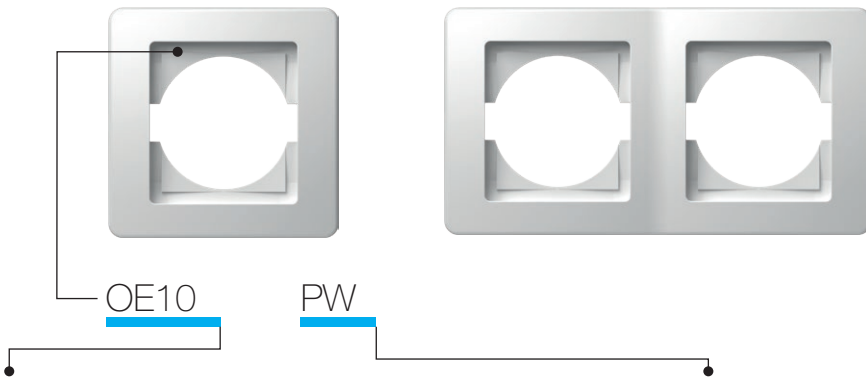

Typ type	Bezeichnung description	Farbe colour
OE10	RAHMEN EKONOMIK 1 SURROUND EKONOMIK 1	<input type="checkbox"/> PW weiß-glänzend polar white
OE20	RAHMEN EKONOMIK 2 HORIZONTAL SURROUND EKONOMIK 2 HORIZONTAL	<input type="checkbox"/> IW beige-glänzend ivory white
OE30	RAHMEN EKONOMIK 3 HORIZONTAL SURROUND EKONOMIK 3 HORIZONTAL	<input type="checkbox"/> ES silber-matt elox silver
⋮	⋮	<input type="checkbox"/> CO weiß, Duroplast white thermoset
⋮	⋮	<input type="checkbox"/> NB schwarz-glänzend night black



- OE10PW
- OE10IW
- OE10ES
- OE10CO
- OE10NB

**RAHMEN EKONOMIK 1**

- dekorativer Rahmen 1-fach  
- entspricht EN 60669-1  
*SURROUND EKONOMIK 1*  
- decorative surround 1-gang  
- in accordance with EN 60669-1

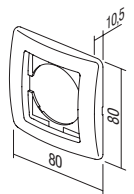

- OE20PW
- OE20IW
- OE20ES
- OE20CO
- OE20NB

**RAHMEN EKONOMIK 2 HORIZONTAL**

- dekorativer Rahmen 2-fach horizontal  
- entspricht EN 60669-1  
*SURROUND EKONOMIK 2 HORIZONTAL*  
- decorative surround 2-gang horizontal  
- in accordance with EN 60669-1

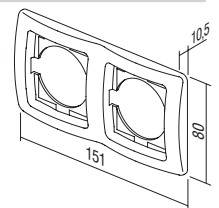

- OE21PW
- OE21IW
- OE21ES
- OE21CO
- OE21NB

**RAHMEN EKONOMIK 2 VERTIKAL**

- dekorativer Rahmen 2-fach vertikal  
- entspricht EN 60669-1  
*SURROUND EKONOMIK 2 VERTIKAL*  
- decorative surround 2-gang vertical  
- in accordance with EN 60669-1

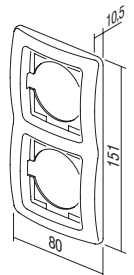

- OE30PW
- OE30IW
- OE30ES
- OE30CO
- OE30NB

**RAHMEN EKONOMIK 3 HORIZONTAL**

- dekorativer Rahmen 3-fach horizontal  
- entspricht EN 60669-1  
*SURROUND EKONOMIK 3 HORIZONTAL*  
- decorative surround 3-gang horizontal  
- in accordance with EN 60669-1

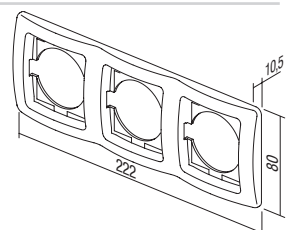



- OE31PW
- OE31IW
- OE31ES
- OE31CO
- OE31NB

**RAHMEN EKONOMIK 3 VERTIKAL**

- dekorativer Rahmen 3-fach vertikal  
- entspricht EN 60669-1

**SURROUND EKONOMIK 3 VERTICAL**

- decorative surround 3-gang vertical  
- in accordance with EN 60669-1

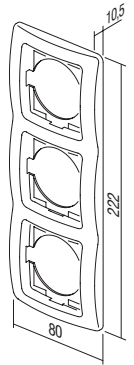

- OE40PW
- OE40IW
- OE40ES
- OE40NB

**RAHMEN EKONOMIK 4 HORIZONTAL**

- dekorativer Rahmen 4-fach horizontal  
- entspricht EN 60669-1

**SURROUND EKONOMIK 4 HORIZONTAL**

- decorative surround 4-gang horizontal  
- in accordance with EN 60669-1

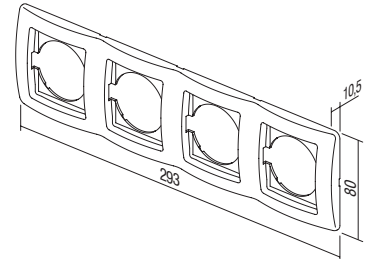

- OE41PW
- OE41IW
- OE41ES
- OE41NB

**RAHMEN EKONOMIK 4 VERTIKAL**

- dekorativer Rahmen 4-fach vertikal  
- entspricht EN 60669-1

**SURROUND EKONOMIK 4 VERTICAL**

- decorative surround 4-gang vertical  
- in accordance with EN 60669-1

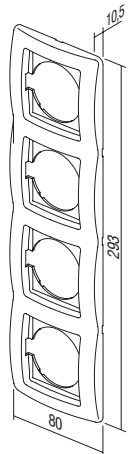

- OE50PW
- OE50IW
- OE50ES
- OE50NB

**RAHMEN EKONOMIK 5 HORIZONTAL**

- dekorativer Rahmen 5-fach horizontal  
- entspricht EN 60669-1

**SURROUND EKONOMIK 5 HORIZONTAL**

- decorative surround 5-gang horizontal  
- in accordance with EN 60669-1

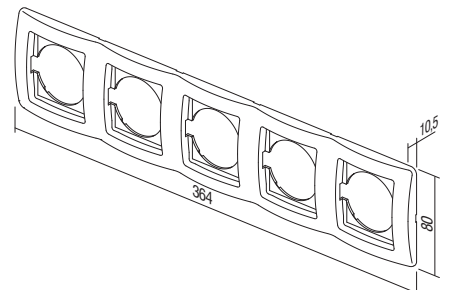

DEKORATIVE RAHMEN COLOR /  
COLOR DECORATIVE FRAMES



OE90GR	GRÜN / GREEN	OE90YL	GELB / YELLOW	OE90MB	MET. BLAU / MET. BLUE
OE90BL	BLAU / BLUE	OE90WH	WEISS / WHITE	OE90BZ	BRONZE / BRONZE
OE90VO	VIOLETT / VIOLET	OE90GY	GRAU / GREY	OE90CR	SILBER / SILVER
OE90PI	ROSA / PINK	OE90BK	SCHWARZ / BLACK	OE90GO	GOLD / GOLD
OE90RD	ROT / RED				





TEM





KATALOG / CATALOGUE

fontana

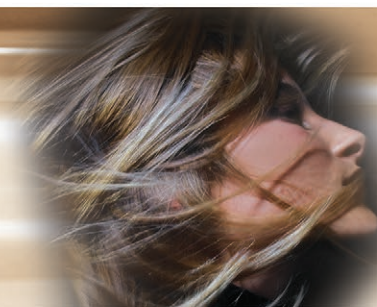

SCHALTER SF  
SWITCHES SF

---



218

STECKDOSEN VF  
SOCKETS VF

---



220

SETS CF  
SETS CF

---



221

ZUBEHÖR AF  
ACCESSORIES AF

---



223

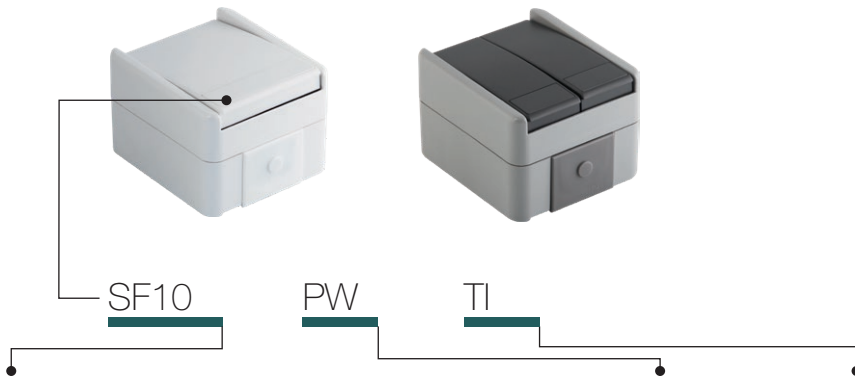

Typ type	Bezeichnung description	Technische Daten technical data	Farbe colour	Optionsbezeichnung 1 optional data 1
SF10	SCHALTER 1-POLIG SWITCH 1WAY	IP44 10AX 250V~	<input type="checkbox"/> PW weiß-matt white-mat	TI Glühlampe + Indikator neon lamp+indication
SF11	TASTER 1-POLIG PUSH BUTTON 1WAY	IP44 10A 250V~	<input checked="" type="checkbox"/> GY grau-matt grey-mat	
SF20	SCHALTER 2-POLIG SWITCH 2POLE	IP44 10AX 250V~		
:	:	:		
:	:	:		

SCHALTER 1-POLIG IP44 10AX 250V~



- SF10PW
- SF10GY

- 10AX 250V~, Typ SF10  
- entspricht EN 60669-1  
- Steckklemmen 1,5-2,5 mm<sup>2</sup>  
*SWITCH 1WAY IP44 10AX 250V~*  
- 10AX 250V~, type SF10  
- in accordance with EN 60669-1  
- plug-in contacts 1.5-2.5mm<sup>2</sup>



SCHALTER 1-POLIG IP44 10AX 250V~ \_\_ TI



- SF10PWTI
- SF10GYTI

- TI Indikator + Glühlampe  
- 10AX 250V~, Typ SF10  
- entspricht EN 60669-1  
- Steckklemmen 1,5-2,5 mm<sup>2</sup>  
*SWITCH 1WAY IP44 10AX 250V~ \_\_ TI*  
- TI indicator+neon lamp  
- 10AX 250V~, type SF10  
- in accordance with EN 60669-1  
- plug-in contacts 1.5-2.5mm<sup>2</sup>



TASTER 1-POLIG IP44 10A 250V~ \_\_ TI



- SF11PWTI
- SF11GYTI

- TI Indikator + Glühlampe  
- 10A 250V~, Typ SF11  
- entspricht EN 60669-1  
- Steckklemmen 1,5-2,5 mm<sup>2</sup>  
*PUSH BUTTON 1WAY IP44 10A 250V~ \_\_ TI*  
- TI indicator+neon lamp  
- 10A 250V~, type SF11  
- in accordance with EN 60669-1  
- plug-in contacts 1.5-2.5mm<sup>2</sup>



SCHALTER 2-POLIG IP44 10AX 250V~



- SF20PW
- SF20GY

- 10AX 250V~, Typ SF20  
- entspricht EN 60669-1  
- Steckklemmen 1,5-2,5 mm<sup>2</sup>  
*SWITCH 2POLE IP44 10AX 250V~*  
- 10AX 250V~, type SF20  
- in accordance with EN 60669-1  
- plug-in contacts 1.5-2.5mm<sup>2</sup>



## SCHALTER SERIEN IP44 10AX 250V~



- SF50PW
- SF50GY

- 10AX 250V~, Typ SF50
- entspricht EN 60669-1
- Steckklemmen 1,5-2,5 mm<sup>2</sup>

## SWITCH 2GANG-1WAY IP44 10AX 250V~

- 10AX 250V~, type SF50
- in accordance with EN 60669-1
- plug-in contacts 1.5-2.5mm<sup>2</sup>



## TASTER SERIEN IP44 10A 250V~



- SF51PW
- SF51GY

- 10A 250V~, Typ SF51
- entspricht EN 60669-1
- Steckklemmen 1,5-2,5 mm<sup>2</sup>

## PUSH BUTTON 2GANG-1WAY IP44 10A 250V~

- 10A 250V~, type SF51
- in accordance with EN 60669-1
- plug-in contacts 1.5-2.5mm<sup>2</sup>



## SCHALTER WECHSEL IP44 10AX 250V~



- SF60PW
- SF60GY

- 10AX 250V~, Typ SF60
- entspricht EN 60669-1
- Steckklemmen 1,5-2,5 mm<sup>2</sup>

## SWITCH 2WAY IP44 10AX 250V~

- 10AX 250V~, type SF60
- in accordance with EN 60669-1
- plug-in contacts 1.5-2.5mm<sup>2</sup>



## SCHALTER WECHSEL IP44 10AX 250V~ \_\_ TI



- SF60PWTI
- SF60GYTI

- TI Indikator + Glühlampe
- 10AX 250V~, Typ SF60
- entspricht EN 60669-1
- Steckklemmen 1,5-2,5 mm<sup>2</sup>

## SWITCH 2WAY IP44 10AX 250V~ \_\_ TI

- TI indicator+neon lamp
- 10AX 250V~, type SF60
- in accordance with EN 60669-1
- plug-in contacts 1.5-2.5mm<sup>2</sup>



## SCHALTER DOPPELT AUS/WECHSEL 10AX 250V~



- SF63PW
- SF63GY

- 10AX 250V~, Typ SF63
- entspricht EN 60669-1
- Steckklemmen 1,5-2,5 mm<sup>2</sup>

## SWITCH 2WAY DOUBLE IP44 10AX 250V~

- 10AX 250V~, type SF63
- in accordance with EN 60669-1
- plug-in contacts 1.5-2.5mm<sup>2</sup>



## SCHALTER KREUZ IP44 10AX 250V~



- SF70PW
- SF70GY

- 10AX 250V~, Typ SF70
- entspricht EN 60669-1
- Steckklemmen 1,5-2,5 mm<sup>2</sup>

## SWITCH INTERMEDIATE IP44 10AX 250V~

- 10AX 250V~, type SF70
- in accordance with EN 60669-1
- plug-in contacts 1.5-2.5mm<sup>2</sup>

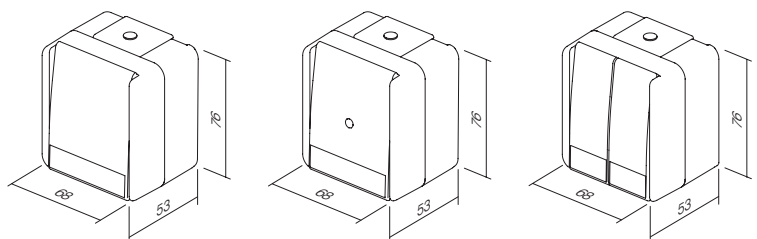

S T E C K D O S E N V F  
S O C K E T S

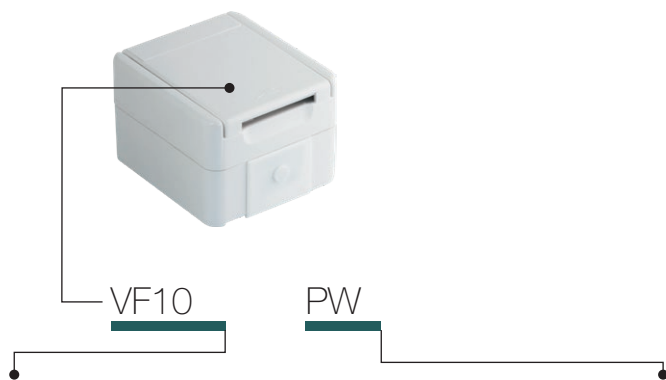

Typ type	Bezeichnung description	Technische Daten technical data	Farbe colour
VF10	STECKDOSE SCHUKO+KLAPPDECKEL SOCKET SCHUKO+COVER	IP44 2P+E 16A 250V~	<input type="checkbox"/> PW weiß-matt white-mat  <input type="checkbox"/> GY grau-matt grey-mat



- VF10PW
- VF10GY

STECKDOSE SCHUKO+KLAPPDECKEL IP44 2P+E 16A 250V~

- Schraubklemmen 1,5-2,5 mm<sup>2</sup>
- Steckdose mit Schutzkontakt mit Klappdeckel
- 16A 250V~, Typ VF10
- entspricht EN 60884-1, CEE7

SOCKET SCHUKO+COVER IP44 2P+E 16A 250V~

- screw contacts 1.5-2.5mm<sup>2</sup>
- 2P+E schuko+cover
- 16A 250V~, type VF10
- in accordance with EN 60884-1, CEE7



- VF12PW
- VF12GY

STECKDOSE SCHUKO+DECKEL IP44 2P+E 16A 250V~ BV

- BV – Steckklemmen 1,5-2,5 mm<sup>2</sup>
- Steckdose mit Schutzkontakt mit Klappdeckel
- 16A 250V~, Typ VF12
- entspricht EN 60884-1, CEE7

SOCKET SCHUKO+COVER IP44 2P+E 16A 250V~ BV

- BV plug-in contacts 1.5-2.5mm<sup>2</sup>
- 2P+E schuko+cover
- 16A 250V~, type VF12
- in accordance with EN 60884-1, CEE7

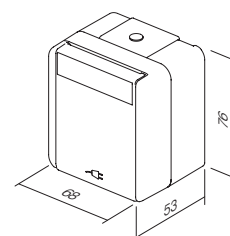

SF10  
SF60

## S E T S C F

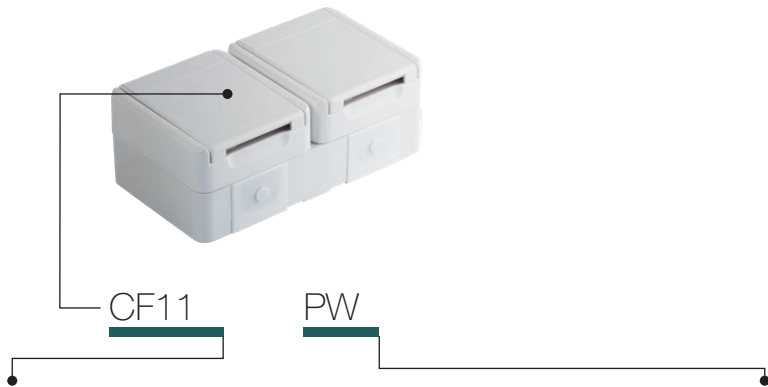

Typ type	Bezeichnung description	Technische Daten technical data	Farbe colour
CF10	SET STECKDOSE SCHUKO DOPPELT HORIZONTAL SOCKET SET SCHUKO DOUBLE HORIZ	2x 2P+E 16A 250V~ IP44	<input type="checkbox"/> PW weiß-matt white-mat
CF11	SET STECKDOSE SCHUKO DOPPELT VERTIKAL SOCKET SET SCHUKO DOUBLE VERT	2x 2P+E 16A 250V~ IP44	<input checked="" type="checkbox"/> GY grau-matt grey-mat
CF12	SET STECKDOSE SCHUKO + SCHALTER WECHSEL HORIZONTAL SOCKET SCH+SWITCH 2WAY HORIZ	16A + 10A 250V~ IP44	
⋮	⋮	⋮	
⋮	⋮	⋮	



- CF10PW  
 CF10GY

## SET STECKDOSE SCHUKO DOPPELT HORIZONTAL IP44 2x 2P+E 16A 250V~

- Schraubklemmen 1,5–2,5 mm<sup>2</sup>
- 2x Steckdose mit Schutzkontakt mit Klappdeckel horizontal
- 16A 250V~, Typ CF10
- entspricht EN 60884-1, CEE7

## SOCKET SET SCHUKO DOUBLE HORIZONTAL IP44 2x 2P+E 16A 250V~

- screw contacts 1.5-2.5mm<sup>2</sup>
- 2x 2P+E schuko+cover horizontal
- 16A 250V~, type CF10
- in accordance with EN 60884-1, CEE7



- CF11PW  
 CF11GY

## SET STECKDOSE SCHUKO DOPPELT VERTIKAL IP44 2x 2P+E 16A 250V~

- Schraubklemmen 1,5–2,5 mm<sup>2</sup>
- 2x Steckdose mit Schutzkontakt mit Klappdeckel vertikal
- 16A 250V~, Typ CF11
- entspricht EN 60884-1, CEE7

## SOCKET SET SCHUKO DOUBLE VERTICAL IP44 2x 2P+E 16A 250V~

- screw contacts 1.5-2.5mm<sup>2</sup>
- 2x 2P+E schuko+cover vertical
- 16A 250V~, type CF11
- in accordance with EN 60884-1, CEE7



- CF12PW  
 CF12GY

## SET STECKDOSE SCHUKO+SCHALTER WECHSEL HORIZONTAL IP44 16A + 10AX 250V~

- Schraubklemmen (Steckdose), Steckklemmen (Schalter) 1,5–2,5 mm<sup>2</sup>
- Steckdose mit Schutzkontakt mit Klappdeckel + Wechselschalter horizontal
- 16A + 10AX 250V~, Typ CF12
- entspricht EN 60884-1, CEE7, EN 60669-1

## SOCKET SCH+SWITCH SET 2WAY HORIZONTAL IP44 16A + 10AX 250V~

- screw (socket), plug-in (switch) contacts 1.5-2.5mm<sup>2</sup>
- 2P+E schuko+cover + switch 2-way horizontal
- 16A + 10AX 250V~, type CF12
- in accordance with EN 60884-1, CEE7, EN 60669-1



**SET STECKDOSE SCHUKO+SCHALTER WECHSEL VERTIKAL IP44  
16A + 10AX 250V~**

- CF13PW
- CF13GY

- Schraubklemmen (Steckdose), Steckklemmen (Schalter) 1,5–2,5 mm<sup>2</sup>
- Steckdose mit Schutzkontakt mit Klappdeckel + Wechselschalter vertikal
- 16A + 10AX 250V~, Typ CF13
- entspricht EN 60884-1, CEE7, EN 60669-1

**SOCKET SCH+SWITCH 2WAY SET  
VERTICAL IP44 16A + 10AX 250V~**

- screw (socket), plug-in (switch)
- contacts 1.5-2.5mm<sup>2</sup>
- 2P+E schuko+cover + switch 2-way vertical
- 16A + 10AX 250V~, type CF13
- in accordance with EN 60884-1, CEE7, EN 60669-1

**SET STECKDOSE SCHUKO DOPPELT HORIZONTAL IP44 2x 2P+E 16A 250V~BV**

- CF14PW
- CF14GY

- BV – Steckklemmen 1,5–2,5 mm<sup>2</sup>
- 2x Steckdose mit Schutzkontakt mit Klappdeckel horizontal
- 16A 250V~, Typ CF14
- entspricht EN 60884-1, CEE7

**SOCKET SET SCHUKO DOUBLE  
HORIZONTAL IP44 2x 2P+E 16A 250V~ BV**

- BV plug-in contacts 1.5-2.5mm<sup>2</sup>
- 2x 2P+E schuko+cover horizontal
- 16A 250V~, type CF14
- in accordance with EN 60884-1, CEE7

**SET STECKDOSE SCHUKO DOPPELT VERTIKAL IP44 2x 2P+E 16A 250V~ BV**

- CF15PW
- CF15GY

- BV – Steckklemmen 1,5–2,5 mm<sup>2</sup>
- 2x Steckdose mit Schutzkontakt mit Klappdeckel vertikal
- 16A 250V~, Typ CF15
- entspricht EN 60884-1, CEE7

**SOCKET SET SCHUKO DOUBLE VERTICAL  
IP44 2x 2P+E 16A 250V~ BV**

- BV plug-in contacts 1.5-2.5mm<sup>2</sup>
- 2x 2P+E schuko+cover vertical
- 16A 250V~, type CF15
- in accordance with EN 60884-1, CEE7

**SET STECKDOSE SCHUKO+SCHALTER WECHSEL HORIZONTAL IP44  
16A + 10AX 250V~ BV**

- CF16PW
- CF16GY

- BV – Steckklemmen 1,5–2,5 mm<sup>2</sup>
- Steckdose mit Schutzkontakt mit Klappdeckel + Wechselschalter horizontal
- 16A + 10AX 250V~, Typ CF16
- entspricht EN 60884-1, CEE7, EN 60669-1

**SOCKET+SWITCH SET SCH+2WAY  
HORIZONTAL IP44 16A + 10AX 250V~ BV**

- BV plug-in contacts 1.5-2.5mm<sup>2</sup>
- 2P+E schuko+cover + switch 2-way horizontal
- 16A + 10AX 250V~, type CF16
- in accordance with EN 60884-1, CEE7, EN 60669-1

**SET STECKDOSE SCHUKO+SCHALTER WECHSEL VERTIKAL IP44  
16A + 10AX 250V~ BV**

- CF17PW
- CF17GY

- BV – Steckklemmen 1,5–2,5 mm<sup>2</sup>
- Steckdose mit Schutzkontakt mit Klappdeckel + Wechselschalter vertikal
- 16A + 10AX 250V~, Typ CF17
- entspricht EN 60884-1, CEE7, EN 60669-1

**SOCKET SCH+SWITCH 2WAY SET  
VERTICAL IP44 16A + 10AX 250V~ BV**

- BV plug-in contacts 1.5-2.5mm<sup>2</sup>
- 2P+E schuko+cover + switch 2-way vertical
- 16A + 10AX 250V~, type CF17
- in accordance with EN 60884-1, CEE7, EN 60669-1



Z U B E H Ö R A F  
A C C E S S O R I E S

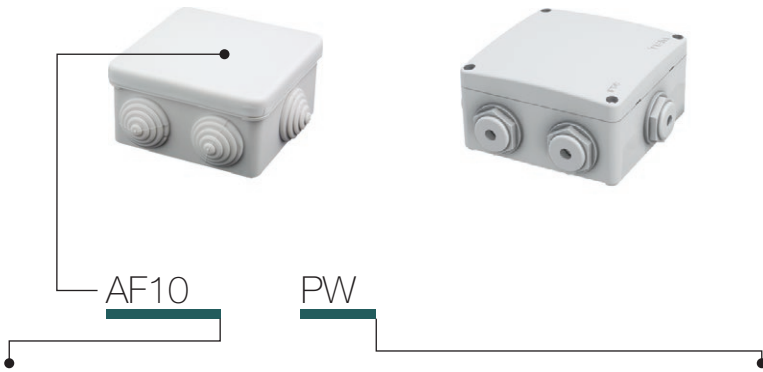

Typ type	Bezeichnung description	Technische Daten technical data	Farbe colour
AF10	ABZWEIGKASTEN DISTRIBUTION BOX	IP44 RN01	<input type="checkbox"/> PW weiß-matt white-mat
AF20	ABZWEIGKASTEN DISTRIBUTION BOX	IP55 NDO1	<input type="checkbox"/> GY grau-matt grey-mat

ABZWEIGKASTEN IP44 RN01



- AF10PW
- AF10GY

- Aufputzabzweigkasten IP44  
- 16A 400V~  
- entspricht IEC/EN 60670-1, IEC/EN 60670-22  
**DISTRIBUTION BOX IP44 RN01**  
- surface mounting distribution box IP44  
- 16A 400V~  
- in accordance with IEC/EN 60670-1, IEC/EN 60670-22

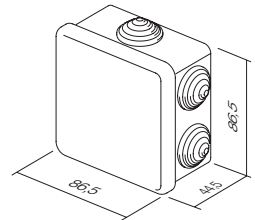

ABZWEIGKASTEN IP55 ND01



- AF20PW
- AF20GY

- Aufputzabzweigkasten IP55  
- inkl. Einführungen  
- entspricht IEC/EN 60670-1, IEC/EN 60670-22  
**DISTRIBUTION BOX IP55 ND01**  
- surface mounting connection box IP55  
- glands included  
- in accordance with IEC/EN 60670-1, IEC/EN 60670-22

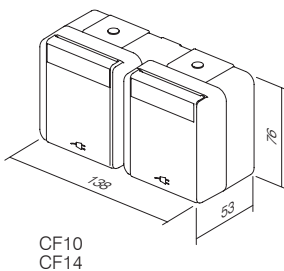
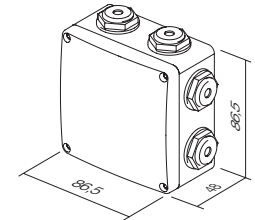

CF10  
CF14

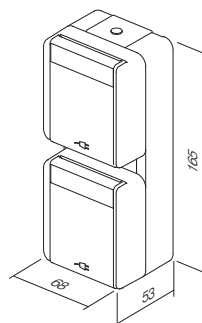

CF11  
CF15

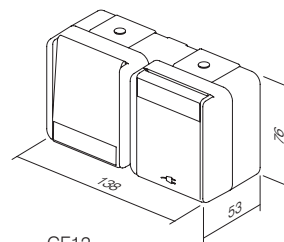

CF12  
CF16

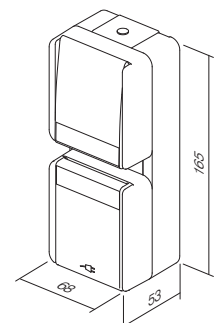

CF13  
CF17

# MODUL —

Typ	Bezeichnung	Seite	Typ	Bezeichnung	Seite
<b>SCHALTER SM</b>			<b>KOMMUNIKATION KM</b>		
SM10	SCHALTER 1-POLIG 16AX 250V~ 1M	68	KM10--	TV-EINZELDOSE 0dB 1M	82
SM11	TASTER 1-POLIG 16A 250V~ 1M	68	KM20--	TV-EINZELDOSE 0dB 2M	82
SM12	SCHALTER 1-POLIG 20A 250V~ 1M	68	KM11--	TV-ENDDOSE 1dB 1M	82
SM20	SCHALTER 2-POLIG 16AX 250V~ 1M	68	KM12--	TV-DURCHGANGSDOSE 10dB 1M	82
SM40	SCHALTER JALOUSIE 1-0-2 16AX 250V~ 1M	69	KM15--	SAT-EINZELDOSE 0dB 1M	83
SM41	TASTER JALOUSIE 1-0-2 16A 250V~ 1M	69	KM24--	SAT-EINZELDOSE 0dB 2M	83
SM60	SCHALTER WECHSEL 16AX 250V~ 1M	69	KM16--	SAT-ENDDOSE 1dB 1M	83
SM61	TASTER WECHSEL 16A 250V~ 1M	69	KM19--	R-EINZELDOSE 0dB 1M	83
SM70	SCHALTER KREUZ 16AX 250V~ 1M	69	KM29--	R-EINZELDOSE 0dB 2M	83
SM10	SCHALTER 1-POLIG 16AX 250V~ 1M	70	KM25--	SAT-TV-ENDDOSE 1dB 2M	83
SM10--IN	SCHALTER 1-POLIG 16AX 250V~ 1M IN	70	KM22--	STECKDOSE AUDIO 2xRCA 1M	84
SM11--	TASTER 1-POLIG 16A 250V~ 1M	70	KM23--	STECKDOSE AUDIO-LAUTSPRECHER 1M	84
SM11--IN01	TASTER 1-POLIG 16A 250V~ 1M IN 01	70	KM26--	STECKDOSE AUDIO-LAUTSPRECHER 2M	84
SM11--IN02	TASTER 1-POLIG 16A 250V~ 1M IN 02	71	KM30--	STECKDOSE TEL LT RJ11 6/4 1M	85
SM20--NT03	SCHALTER 2-POLIG 16AX 250V~ 1M NT 03	71	KM31--	STECKDOSE TEL BT SEC 6/6 1M	85
SM20--IN	SCHALTER 2-POLIG 16AX 250V~ 1M IN	71	KM36--	STECKDOSE TEL KS RJ11 6/4 1M	85
SM40--NT10	SCHALTER JALOUSIE 1-0-2 16AX 250V~ 1M NT 10	71	KM37--	STECKDOSE CAT5e KS RJ45 8/8 1M	85
SM41--NT10	TASTER JALOUSIE 1-0-2 16A 250V~ 1M NT 10	71	KM35--	ADAPTER KS 1M	85
SM60--	SCHALTER WECHSEL 16AX 250V~ 1M	71	KM38--	ADAPTER KS MIT STAUBSCHUTZ 1M	85
SM61--	TASTER WECHSEL 16A 250V~ 1M	72	KM39--	STECKDOSE CAT6 RJ45 SCH KS 8/8 1M	86
SM62--CD	TASTER WECHSEL MIT SCHNUR 16A 250V~ 1M CD	72	KM50--	ADAPTER KS UNIVERSAL 1M	86
SM70--	SCHALTER KREUZ 16AX 250V~ 1M	72	KM40--	ADAPTER PD 1M	86
<b>WIPPE TM</b>			KM43--	ADAPTER PD MIT STAUBSCHUTZ 1M	86
TM11--	WIPPE 1M	73	KM46--	ADAPTER R&M 1M	86
TM11--IN	WIPPE 1M IN	73	KM52--	ADAPTER R&M CAT6A 1M	86
TM12--	WIPPE 2M	73	KM47--	ADAPTER R&M MIT STAUBSCHUTZ 1M	87
TM12--IN	WIPPE 2M IN	73	KM53--	ADAPTER R&M CAT6A MIT STAUBSCHUTZ 1M	87
TM13--IL	WIPPE 2M MIT NAMENSSCHILD	74	KM45	ADAPTER LK 1M	88
TM15--	WIPPE 1M 2-POLIG	74	KA26	ADAPTER NEXSANS/SCHRACK 2M	88
TM21--	BLENDE 1M	74	KM48--	ADAPTER AT&T SYSTIMAX MIT STAUBSCHUTZ 1M	88
TM22--	BLENDE 2M	74	KM51--	STECKDOSE USB TYP A 1M	88
TM31--	KABELEINFÜHRUNG 1M	74	<b>KOMMUNIKATIONSZUBEHÖR KA</b>		
<b>BELEUCHTUNG IA</b>			KA10	KONNEKTOR KS CAT3 RJ11 6/4	89
IA10--	GLÜHLAMPE 230V~ 0,34W	76	KA11	KONNEKTOR KS CAT5e RJ45 8/8	89
IA20--	LED-LAMPE 230V AC/DC 0,4W	76	KA12	KONNEKTOR KS CAT5e RJ45 8/8	89
IA21--	LED-LAMPE 24V AC/DC 0,2W	76	KA15	KONNEKTOR KS CAT6 SCHRACK RJ45 8/8	89
IA22--	LED-LAMPE 12V AC/DC 0,1W	76	KA16	KONNEKTOR KS CAT6S SCHRACK RJ45 8/8	89
IA50	RC-SCHALTUNG 250V~	76	KA17	KONNEKTOR KS CAT6a SCHRACK RJ45 8/8	89
<b>STECKDOSEN VM</b>			KA18	KONNEKTOR SLIM KS CAT6S SCHRACK RJ45 8/8	90
VM10--	STECKDOSE SCHUKO+KS 2P+E 16A 250V~ 2M	78	KA27	KONNEKTOR KS HDMI	90
VM11--	STECKDOSE SCHUKO+KS+KLAPPDECKEL 2P+E 16A 250V~ 2M	78	KA28	KABEL KS HDMI	90
VM20--	STECKDOSE EURO+KS 2P 10A 250V~ 1M	79	<b>ELEKTRONIK EM</b>		
VM40--	STECKDOSE FRANZÖSISCH+KS 2P+E 16A 250V~ 2M	79	EM10--	DIMMER DREH-AUS RL 300W 1M	91
VM41--	STECKDOSE FRANZÖSISCH+KS+KLAPPDECKEL 2P+E 16A 250V~ 2M	79	EM12--	DIMMER DREH-WECHSEL RL 300W 1M	91
VM30--	STECKDOSE ITALIENISCH P17/11+KS 2P+E 16A 250V~ 1M	79	EM13--	DIMMER DREH-WECHSEL LED 60W 1M	92
VM31--	STECKDOSE SCHUKO/ITALIENISCH P17/11+KS 2P+E 16A 250V~ 2M	79	EM14--	DIMMER DREH-WECHSEL LED 180W	92
VM32--	STECKDOSE SCHUKO/ITALIENISCH P30+KS 2P+E 16A 250V~ 2M	80	EM15--	DIMMER DREH-AUS R 250W 1M	92
VM33--	STECKDOSE ITALIENISCH P11+KS 2P+E 10A 250V~ 1M	80	EM23	EINBAUDIMMER R (250 W), (RC,RL 200VA)	93
VM21--	STECKDOSE EURO/AMERIKANISCH+KS 2P 16A 250V~ 1M	80	EM18	DIMMER EINBAU LED 250W	93
VM51--	STECKDOSE BRITISCH BS546+KS 2P+E 15A 250V~ 2M	80	EM19	DIMMER EINBAU DC LED 96W	93
VM52--	STECKDOSE BRITISCH BS 1363+KS 2P+E 13A 250V~ 2M	80	EM25--	SCHALTER/DIMMER UNIVERSAL RLC 0-300W 2M	95
VM80	ÜBERSpannungsschutz MPE MINI 275V/50Hz	80	EM26--	KONTROLLTASTER 2M	97
			EM27	STÖRUNGSFLITER	97
			EM25PPOL20	SET SCHALTER/DIMMER UNIVERSAL RLC 0-300W 2M PP OL20	97
			EM31--	IR-SCHALTER 5A 230V~ 1M	98
			EM32--	IR-SCHALTER 5A 230V~ 2M	98
			EM37--	ELEKTRONISCHES THERMOSTAT 6A 230V~ 2M	100
			NM39	MONTAGETRÄGER MIT SCHRAUBEN FÜR THERMOSTATE FANTINI COSMI 3M	101
			EM40--	ENERGIESPAR-KARTENSCHALTER 3A 250V~ 3M	101
			EM47	KARTE ISO	101
			EM44--	ENERGIESPAR-KARTENSCHALTER RF HF 13,56MHz 3M	102
			EM49	RELAISEINHEIT FÜR KARTENSCHALTER 2x16A 250V~	102
			EM45	KABELEINFÜHRUNG SPL-1	102
			EM60--	RASIERSTECKDOSE 230V~/120V~ 3M	103
			EM66--	LADEGERÄT USB 5V 2,1A 1M	103
			EM65--	LADEGERÄT USB 5V 1A 2M	103
			EM67--	LADEGERÄT USB 5V 2,4A 1M	104
			EM55	LED-NOTLEUCHTE 250V~ 0,9W, NiCd 3h 7M	104
			EM57	LED-NOTLEUCHTE 230V~50Hz, 0,5W, NiMH 2h 2M	104
			EM50--	LED-LAMPE EINFARBIG 250V~ 0,8W 2M	105
			EM51--	LED-LAMPE ZWEIFARBIG 250V~ 2x0,4W 2M	105
			EM52--	LED-LAMPE 3D ZWEIFARBIG 250V~ 2x0,4W 2M	105
			EM71--	FINGERABDRUCKLESER BIOPASS 2M	106
			EM80	SCHALTER BERÜHRUNGSLÖS 10A 240V~	107
			EM81	KONTROLLSCHALTER BERÜHRUNGSLÖS	107
			EM90--	SUMMER 8VA 230V~ 1M	108
			EM91--	SUMMER 8VA 12V~ 1M	108
			EM92--	KLINGEL 8VA 230V~ 1M	108
			EM93--	KLINGEL 8VA 12V~ 1M	108
			EM95--	LAUTSTÄRKENREGLER FÜR 100 V AUDIOLINIE 35W 2M	109
			EM96--	NIEDEROHMIGER LAUTSTÄRKENREGLER 4-8 Ω 35W 2M	109



Typ	Bezeichnung	Seite	Typ	Bezeichnung	Seite
<b>SETS CM</b>			<b>D O S E N</b>		
CM10--	SET STECKDOSEN 2x SCHUKO 2P+E 16A 250V~ 4M	110	<b>RUNDDOSEN</b>		
CM11--	SET STECKDOSEN 3x SCHUKO 2P+E 16A 250V~ 7M	110	DE10	RUNDDOSE ZIEGELWAND SM60-01	140
CM15	SET VERDRAHTUNGSBRÜCKEN FARBIG 3x1,5mm <sup>2</sup> 1M	111	DE11	RUNDDOSE ZIEGELWAND TIEF SM60-06	140
CM16	SET VERDRAHTUNGSBRÜCKEN FARBIG 3x2,5mm <sup>2</sup> 2M	111	DE30	ABSTANDSTUTZEN SM60-03	140
CM17	SCHRAUBEN-SET 3,5x20	111	DE31	ABSTANDSTUTZEN SM60-04	140
CM18	SCHRAUBEN-SET 3,5x35	111	DE12	RUNDDOSE ZIEGELWAND MD65-46	141
CM19	SCHRAUBEN-SET 3,5x50	111	DE13	RUNDDOSE ZIEGELWAND TIEF MD65-60	141
CM22--	SCHALTER-SET IP44 2M	111	DE14	VERLÄNGERUNG FÜR RUNDDOSE ZIEGELWAND MD65-46	141
CM23--	STECKDOSE-SET IP44 2M	111	DE32	ABSTANDSTUTZEN MD65-71	141
CM25--OL	BADEZIMMER-SET 3x20A 250V~ 4M OL	111	DE33	ABSTANDSTUTZEN MD65-91	141
CM25--OS	BADEZIMMER-SET 3x20A 250V~ 4M OS	111	DE20	FEDERDECKEL 60	141
NM41	MONTAGETRÄGER FÜR BADEZIMMER-SET 4M	112	DE21	FEDERDECKEL 65	141
OL41--	RAHMEN LINE FÜR BADEZIMMER-SET	112	DE22	ABDECKUNG DEKORATIV SM60	141
OS41--	RAHMEN SOFT FÜR BADEZIMMER-SET	112	HE10	RUNDDOSE HOHLWAND SM68x40	144
<b>ANTIBAKTERIENPROGRAMM AW</b>			HE11	RUNDDOSE HOHLWAND SM68x55	144
TM11AW--	WIPPE 1M	115	BE10	RUNDDOSE BETONWAND 60-49	144
TM11AWIN	WIPPE 1M IN	115	BE11	RUNDDOSE BETONWAND TIEF 60-77	144
TM12AW--	WIPPE 2M	115	BE20	GEGENLAGER FÜR RUNDDOSE BETONWAND	144
TM12AWIN	WIPPE 2M IN	115	BE21	ROHREINFÜHRUNG 16 FÜR RUNDDOSE BETONWAND	144
TM21AW--	BLENDE 1M	115	<b>RECHTECKDOSEN</b>		
TM22AW--	BLENDE 2M	115	DM30	RECHTECKDOSE ZIEGELWAND PM3	148
VM10AW--	STECKDOSE SCHUKO+KS 2P+E 16A 250V~ 2M	116	DM31	RECHTECKDOSE ZIEGELWAND PM3-65	148
VM11AW--	STECKDOSE SCHUKO+KS+KLAPPDECKEL 2P+E 16A 250V~ 2M	116	DM40	RECHTECKDOSE ZIEGELWAND PM4	148
VM20AW--	STECKDOSE EURO+KS 2P 10A 250V~ 1M	116	DM41	RECHTECKDOSE ZIEGELWAND PM4-65	148
KM11AW--	TV-ENDDOSE 1dB 1M	116	DM70	RECHTECKDOSE ZIEGELWAND PM7	149
KM35AW--	ADAPTER KS 1M	116	DM71	RECHTECKDOSE ZIEGELWAND PM7-65	149
OS20AW--	RAHMEN SOFT 2M	117	DM72	RECHTECKDOSE ZIEGELWAND PM72-65	149
OS24AW--	RAHMEN SOFT 2x2M	117	DM80	ABSTANDHALTER FÜR RECHTECKDOSE PM	149
OS26AW--	RAHMEN SOFT 3x2M	117	DM33	FEDERDECKEL PM3	150
OS26AW--	RAHMEN SOFT 3x2M	117	DM34	ABDECKUNG DEKORATIV PM3	150
OS30AW--	RAHMEN SOFT 3M	117	DM43	FEDERDECKEL PM4	150
OS40AW--	RAHMEN SOFT 4M	117	DM44	ABDECKUNG DEKORATIV PM4	150
OS70AW--	RAHMEN SOFT 7M	117	DM73	FEDERDECKEL PM7	150
<b>RAHMEN PURE OP</b>			DM74	ABDECKUNG DEKORATIV PM7	150
OP20--	RAHMEN PURE 2M	120	DM75	ABDECKUNG DEKORATIV PM72	151
OP24--	RAHMEN PURE 2x2M	120	HM30	RECHTECKDOSE HOHLWAND VM3	151
OP26--	RAHMEN PURE 3x2M	120	HM40	RECHTECKDOSE HOHLWAND VM4	152
OP28	RAHMEN PURE 4x2M	120	HM70	RECHTECKDOSE HOHLWAND VM7	152
OP30--	RAHMEN PURE 3M	121	HM72	RECHTECKDOSE HOHLWAND VM72	152
OP40--	RAHMEN PURE 4M	121	BM30	RECHTECKDOSE BETONWAND BM3	153
OP70--	RAHMEN PURE 7M	121	BM40	RECHTECKDOSE BETONWAND BM4	153
OP13--	RAHMEN PURE 1/3M	121	BM70	RECHTECKDOSE BETONWAND BM7	153
OP23--	RAHMEN PURE 2/3M	121	BM80	BEFESTIGUNGSELEMENT FÜR DOSEN BM	153
<b>RAHMEN LINE OL</b>			BM82	DISTANZPROFIL FÜR DOSEN	153
OL20--	RAHMEN LINE 2M	124	<b>ABZWEIGDOSEN</b>		
OL24--	RAHMEN LINE 2x2M	124	DW10	ABZWEIGDOSE RUND ZIEGELWAND DSM78	156
OL26--	RAHMEN LINE 3x2M	124	HW10	ABZWEIGDOSE RUND HOHLWAND SM78x45	156
OL28--	RAHMEN LINE 4x2M	124	DE23	ABDECKUNG DEKORATIV SM78	156
OL29--	RAHMEN LINE 5x2M	124	DE24	FEDERDECKEL 78	156
OL30--	RAHMEN LINE 3M	125	HW20	ABZWEIGKASTEN ZIEGELWAND SM105x105	156
OL40--	RAHMEN LINE 4M	125	<b>VERDRAHTUNGSZUBEHÖR</b>		
OL70--	RAHMEN LINE 7M	125	UW10--	DOSENKLEMMLEISTEN GESCHLOSSEN PC 2x2,5 mm <sup>2</sup> 10P	158
QL10--	RAHMEN LINE 1/2M	125	UW11--	DOSENKLEMMLEISTEN GESCHLOSSEN PC 2x4 mm <sup>2</sup> 10P	158
QL13--	RAHMEN LINE 1/3M	125	UW12--	DOSENKLEMMLEISTEN GESCHLOSSEN PC 2x6 mm <sup>2</sup> 10P	158
QL23--	RAHMEN LINE 2/3M	125	UW15--	DOSENKLEMMLEISTEN PA 2x2,5 mm <sup>2</sup> 12P	158
<b>RAHMEN SOFT OS</b>			UW16--	DOSENKLEMMLEISTEN PA 2x4 mm <sup>2</sup> 12P	158
OS20--	RAHMEN SOFT 2M	128	UW17--	DOSENKLEMMLEISTEN PA 2x6 mm <sup>2</sup> 12P	158
OS24--	RAHMEN SOFT 2x2M	128	UW29--	LÜSTER-KLEMMLEISTEN PP 1.0-4.0 mm <sup>2</sup> 12P	158
OS26--	RAHMEN SOFT 3x2M	128	UW30--	LÜSTER-KLEMMLEISTEN PP 1.5-6.0 mm <sup>2</sup> 12P	158
OS28--	RAHMEN SOFT 4x2M	128	UW31--	LÜSTER-KLEMMLEISTEN PP 2.5-10 mm <sup>2</sup> 12P	158
OS30--	RAHMEN SOFT 3M	129	UW32--	LÜSTER-KLEMMLEISTEN PP 4-16 mm <sup>2</sup> 12P	158
OS40--	RAHMEN SOFT 4M	129	UW25--	LÜSTER-KLEMMLEISTEN PA 1.0-4.0 mm <sup>2</sup> 12P	159
OS70--	RAHMEN SOFT 7M	129	UW26--	LÜSTER-KLEMMLEISTEN PA 1.5-6.0 mm <sup>2</sup> 12P	159
OS72--	RAHMEN SOFT 2x7M	129	UW27--	LÜSTER-KLEMMLEISTEN PA 1.5-6.0 mm <sup>2</sup> 12P	159
OS10--	RAHMEN SOFT 1/2M	129	UW28--	LÜSTER-KLEMMLEISTEN PA 1.5-6.0 mm <sup>2</sup> 12P	159
OS13--	RAHMEN SOFT 1/3M	129	UW40--	STECKKLEMMEN PA 1,5 mm <sup>2</sup> 3P	159
OS23--	RAHMEN SOFT 2/3M	129	UW41--	STECKKLEMMEN PA 1,5 mm <sup>2</sup> 5P	159
<b>MONTAGETRÄGER NM</b>			UW42--	STECKKLEMMEN PA 1,5 mm <sup>2</sup> 8P	159
NM20	MONTAGETRÄGER MIT KRALLEN 2M	134	UW45--	STECKKLEMMEN PA 2,5 mm <sup>2</sup> 3P	159
NM21	MONTAGETRÄGER OHNE SCHRAUBEN 2M	134	UW46--	STECKKLEMMEN PA 2,5 mm <sup>2</sup> 4P	159
NM24	MONTAGETRÄGER METALL MIT KRALLEN 2M	134	UW47--	STECKKLEMMEN PA 2,5 mm <sup>2</sup> 5P	159
NM25	MONTAGETRÄGER METALL OHNE SCHRAUBEN 2M	134	UW50--	STECKKLEMMEN PA 2,5 mm <sup>2</sup> 2/1P	159
NM30	MONTAGETRÄGER MIT SCHRAUBEN 3M	135			
NM40	MONTAGETRÄGER MIT SCHRAUBEN 4M	135			
NM70	MONTAGETRÄGER MIT SCHRAUBEN 7M	135			
NM72	MONTAGETRÄGER MIT SCHRAUBEN 2x7M	135			
NM10	MONTAGETRÄGER MIT KRALLEN 1/2M	136			
NM11	MONTAGETRÄGER OHNE SCHRAUBEN 1/2M	136			
NM23	MONTAGETRÄGER MIT KRALLEN 2/3M	136			
NM32	MONTAGETRÄGER MIT SCHRAUBEN 2/3M	136			

## Vertrieb

Typ	Bezeichnung	Seite
<b>AUFPUTZGEHÄUSE CUBO IP20 AC</b>		
AC11--	AUFPUTZGEHÄUSE NO CUBO MIT BODEN IP20 1M	162
AC21--	AUFPUTZGEHÄUSE NO CUBO MIT BODEN IP20 2M	162
AC41--	AUFPUTZGEHÄUSE NO CUBO MIT BODEN IP20 4M	162
AC61--	AUFPUTZGEHÄUSE NO CUBO MIT BODEN IP20 6M	162
<b>AUFPUTZGEHÄUSE CUBO IP55 AQ</b>		
AQ20--	AUFPUTZGEHÄUSE NO CUBO IP55 2M	163
AQ22--	AUFPUTZGEHÄUSE NO CUBO IP55 2x2M	163
AQ30--	AUFPUTZGEHÄUSE NO CUBO IP55 3M	163
AQ31--	UNTERPUTZGEHÄUSE PO CUBO IP55 3M	163
AQ21--	UNTERPUTZGEHÄUSE PO CUBO IP55 2M	164
<b>BRÜSTUNGSKANÄLE ALU MA</b>		
RT10	ADAPTER MA 92	165
RT12--	RAHMEN MA 92 2/3M	165
RT14--	RAHMEN MA 92 4M	165
RT17--	RAHMEN MA 92 7M	165
RT20--	KANALUNTERTEIL MA 130x65	166
RT21--	KANALUNTERTEIL MA 165x65	166
RT25--	FRONTABDECKUNG MA 92	166
RT30	TRENNWAND MA 43	166
RT31	TRENNWAND MA 43 AL	166
RT32	TRENNWAND MA 43 AL DOPPELT	166
RT35--	ENDSTÜCK MA 130x65	167
RT36--	ENDSTÜCK MA 165x65	167
RT38	VERBINDUNGSSTÜCK MA 65	167
RT40--	UNIVERSALECK MA 130x65	167
RT41--	UNIVERSALECK MA 165x65	167
RT42	ERDUNGSKLEMMME MA 2x A6.3	167
RT43--	FLACHWINKEL MA 130x65	168
RT44--	FLACHWINKEL MA 165x65	168
RT45--	T-STÜCK MA 130x65	168
RT46--	T-STÜCK MA 165x65	168
RT50--	BEFESTIGUNGSPLATTE EINFACH MA 130x65	169
RT51--	BEFESTIGUNGSPLATTE DOPPELT MA 130x65	169
RT52--	SERVICESÄULE MA 130x65x500	169
RT53--	SERVICESÄULE DOPPELTI MA 130x65x500	169
<b>BODENDOSEN MT</b>		
RB30	BODENDOSE MT 7 H=53 mm	171
RB40	BODENDOSE MT 7 H=88 mm	171
RB31	UNTERSATZ FÜR BODENDOSEN MT 7 H=53 mm	171
RB41	UNTERSATZ FÜR BODENDOSEN MT 7 H=88 mm	171
RB33	BODENDOSE MT 14 H=53 mm	171
RB43	BODENDOSE MT 14 H=88mm	171
RB34	UNTERSATZ FÜR BODENDOSEN MT 14 H=53 mm	172
RB44	UNTERSATZ FÜR BODENDOSEN MT 14 H=88 mm	172
RB36	BODENDOSE MT 21 H=53 mm	172
RB46	BODENDOSE MT 21 H=88 mm	172
RB37	UNTERSATZ FÜR BODENDOSEN MT 21 H=53 mm	172
RB47	UNTERSATZ FÜR BODENDOSEN MT 21 H=88 mm	172
<b>VERTEILERKASTEN MO</b>		
RB10	ADAPTER FÜR DIN-LEISTE 35 mm 1M	173
RB11	ADAPTER FÜR DIN-LEISTE 35 mm 2M	173
RB20	VERTEILERKASTEN MO 12+2	174
RB21	VERTEILERKASTEN MO 24+4	174
RB22	VERTEILERKASTEN MO 36+6	174
RB23	VERTEILERKASTEN MO 48+8	174

## ökonomik

Typ	Bezeichnung	Seite
<b>SCHALTER SE</b>		
SE10	SCHALTER 1-POLIG 10AX 250V~	188
SE11	TASTER 1-POLIG 10A 250V~	188
SE22	SCHALTER 2-POLIG 16AX 250V~	188
SE50	SCHALTER SERIEN 10AX 250V~	188
SE51	TASTER SERIEN 10A 250V~	189
SE52	SCHALTER JALOUSIE 10AX 250V~	189
SE53	TASTER JALOUSIE 10A 250V~	189
SE60	SCHALTER WECHSEL 10AX 250V~	189
SE63	SCHALTER DOPPEL AUS/WECHSEL 10AX 250V~	189
SE70	SCHALTER KREUZ 10AX 250V~	189
SE10	SCHALTER 1-POLIG 10AX 250V~	190
SE10--IN	SCHALTER 1-POLIG 10AX 250V~ IN	190
SE11	TASTER 1-POLIG 10A 250V~	190
SE11--TI50	TASTER 1-POLIGO 10A 250V~ TI 50	190
SE11--TI51	TASTER 1-POLIGO 10A 250V~ TI 51	190
SE11--IL	TASTER 1-POLIG 10A 250V~ IL	190
SE22--IN03	SCHALTER 2-POLIG 10AX 250V~ IN 03	190
SE50	SCHALTER SERIEN 10AX 250V~	191
SE51	TASTER SERIEN 10A 250V~	191
SE52--NT09	SCHALTER JALOUSIE 10AX 250V~ NT 09	191
SE53--NT09	TASTER JALOUSIE 10A 250V~ NT 09	191
SE60	SCHALTER WECHSEL 10AX 250V~	191
SE63	SCHALTER DOPPEL AUS/WECHSEL 10AX 250V~	191
SE70	SCHALTER KREUZ 10AX 250V~	191
<b>WIPPEN TE</b>		
TE10--	WIPPE NORMAL	192
TE10--IN	WIPPE NORMAL IN	192
TE13--IL	WIPPE MIT NAMENSSCHILD	192
TE10--	WIPPE SERIEN	192
<b>BELEUCHTUNG IA</b>		
IA10--	GLÜHLAMPE 230V~ 0,34W	193
IA20--	LED-LAMPE 230V AC/DC 0,4W	193
IA21--	LED-LAMPE 24V AC/DC 0,2W	193
IA22--	LED-LAMPE 12V AC/DC 0,1W	193
<b>STECKDOSEN VE</b>		
VE10--XO	STECKDOSE SCHUKO 2P+E 16A 250V~ XO	196
VE11--XO	STECKDOSE SCHUKO+DECKEL 2P+E 16A 250V~ XO	196
VE12--XO	STECKDOSE SCHUKO 2P+E 16A 250V~ BV XO	196
VE13--XO	STECKDOSE SCHUKO+KLAPPDECKEL 2P+E 16A 250V~ BV XO	196
VE10--	STECKDOSE SCHUKO 2P+E 16A 250V~	196
VE11--	STECKDOSE SCHUKO+KLAPPDECKEL 2P+E 16A 250V~	196
VE12--	STECKDOSE SCHUKO 2P+E 16A 250V~ BV	196
VE13--	STECKDOSE SCHUKO+KLAPPDECKEL 2P+E 16A 250V~ BV	196
VE40--XO	STECKDOSE FRANZÖSISCH 2P+E 16A 250V~ XO	193
VE41--XO	STECKDOSE FRANZÖSISCH+KLAPPDECKEL 2P+E 16A 250V~ XO	197
VE42--XO	STECKDOSE FRANZÖSISCH 2P+E 16A 250V~ BV XO	197
VE43--XO	STECKDOSE FRANZÖSISCH+KLAPPDECKEL 2P+E 16A 250V~ BV XO	197
VE40--	STECKDOSE FRANZÖSISCH 2P+E 16A 250V~	197
VE41--	STECKDOSE FRANZÖSISCH+KLAPPDECKEL 2P+E 16A 250V~	197
VE42--	STECKDOSE FRANZÖSISCH 2P+E 16A 250V~ BV	197
VE43--	STECKDOSE FRANZÖSISCH+KS+KLAPPDECKEL 2P+E 16A 250V~ BV	197
VE16--	STECKDOSE SCHUKO DOPPELT 2P+E 16A 250V~	198
VE46--	STECKDOSE FRANZÖSISCH DOPPELT 2P+E 16A 250V~	198
VE30--	STECKDOSE 2P 16A 250V~	198
<b>KOMMUNIKATION KE</b>		
KE11	STECKDOSE TV-R-ENDDOSE 1dB	199
KE12	STECKDOSE TV-R-DURCHGANGSDOSE 10dB	199
KE16	STECKDOSE SAT-TV-R-ENDDOSE 3dB	199
KE36	STECKDOSE TEL KS RJ11 6/4	199
KE37	STECKDOSE CAT5e KS RJ45 8/8	200
KE40	STECKDOSE CAT6s KS RJ45 8/8 SLIM	200
KE38	STECKDOSE TEL KS DOPPELT 2x RJ11 6/4	200
KE39	STECKDOSE CAT5e KS DOPPELT 2x RJ45 8/8	200
KE41	STECKDOSE CAT6s KS DOPPELT 2x RJ45 8/8 SLIM	200
KE45	ADAPTER KS EINFACH	200
KE46	ADAPTER KS DOPPELT	201
KE47	ADAPTER PD DOPPELT	201
KE10--	STECKDOSE TV-EINZELDOSE 0dB	202
KE11	STECKDOSE TV-R-ENDDOSE 1dB	202
KE12	STECKDOSE TV-R-DURCHGANGSDOSE 10dB	202
KE16	STECKDOSE SAT-TV-R-ENDDOSE 3dB	202
KE22--	STECKDOSE AUDIO 2xRCA	202
KE23--	STECKDOSE AUDIO FÜR LAUTSPRECHER	202
KE36	STECKDOSE TEL KS RJ11 6/4	202
KE37	STECKDOSE CAT5e KS RJ45 8/8	203
KE40--	STECKDOSE CAT6s KS RJ45 8/8 SLIM	203
KE38	STECKDOSE TEL KS DOPPELT 2x RJ11 6/4	203
KE39	STECKDOSE CAT5e KS DOPPELT 2x RJ45 8/8	203
KE41--	STECKDOSE CAT6s KS DOPPELT 2x RJ45 8/8 SLIM	203
KE35--	STECKDOSE TEL LT RJ11 6/4 1M	203

Typ	Bezeichnung	Seite
<b>DECKEL PA</b>		
PE10--	DECKEL TV-R 2P/3P	204
PE20--	DECKEL KS EINFACH	204
PE21--	DECKEL KS/PD DOPPELT	204
PE30--	DECKEL TAE/TDO	204
PE32--	DECKEL IR-BEWEGUNGSMELDER	204
<b>ELEKTRONIK EE</b>		
EE15	DIMMER DREH-WECHSEL RL 400W	205
EE16	DIMMER DREH-WECHSEL RLC 400W	205
EE19	DIMMER DREH-WECHSEL LED 100W	206
EE15--	DIMMER DREH-WECHSEL RL 400W	206
EE16--	DIMMER DREH-WECHSEL RLC 400W	207
EE19--	DIMMER DREH-WECHSEL LED 100W	207
EE32--	IR SCHALTER 5A 250V~	207
<b>DECKEL ELEKTRONIK PE</b>		
PE41--	DECKEL FÜR DIMMER Ø6	209
<b>ZUBEHÖR AE</b>		
AE10--	BLENDE	210
AE20--	HERDANSCHLUßDOSE 3P+N+E 5x4mm <sup>2</sup>	210
AE30--	AUFPUTZGEHÄUSE 1	210
AE31--	AUFPUTZGEHÄUSE DOPPELSTECKDOSE	210
AE50--	TAPETENSCHUTZ	211
AE51--	KINDERSCHUTZ KS	211
<b>RAHMEN OE</b>		
OE10--	RAHMEN EKONOMIK 1	212
OE20--	RAHMEN EKONOMIK 2 HORIZONTAL	212
OE21--	RAHMEN EKONOMIK 2 VERTIKAL	212
OE30--	RAHMEN EKONOMIK 3 HORIZONTAL	212
OE31--	RAHMEN EKONOMIK 3 VERTIKAL	213
OE40--	RAHMEN EKONOMIK 4 HORIZONTAL	213
OE41--	RAHMEN EKONOMIK 4 VERTIKAL	213
OE50--	RAHMEN EKONOMIK 5 HORIZONTAL	213
OE90--	DEKORATIV RAHMEN COLOR	214
<b>fontana</b>		
Typ	Bezeichnung	Seite
<b>SCHALTER SF</b>		
SF10--	SCHALTER 1-POLIG IP44 10AX 250V~	218
SF10--TI	SCHALTER 1-POLIG IP44 10AX 250V~ TI	218
SF11--TI	TASTER 1-POLIG IP44 10A 250V~ TI	218
SF20--	SCHALTER 2-POLIG IP44 10AX 250V~	218
SF50--	SCHALTER SERIEN IP44 10AX 250V~	219
SF51--	TASTER SERIEN IP44 10A 250V~	219
SF60--	SCHALTER WECHSEL IP44 10AX 250V~	219
SF60--TI	SCHALTER WECHSEL IP44 10AX 250V~ TI	219
SF63--	SCHALTER DOPPELT AUS/WECHSEL IP44 10AX 250V~	219
SF70--	SCHALTER KREUZ IP44 10AX 250V~	219
<b>STECKDOSEN VF</b>		
VE10--	STECKDOSE SCHUKO + KLAPPDECKEL IP44 2P+E 16A 250V~	220
VF12--	STECKDOSE SCHUKO + KLAPPDECKEL IP44 2P+E 16A 250V~ BV	220
<b>SETS CF</b>		
CF10--	SET STECKDOSE SCHUKO DOPPELT HORIZONTAL IP44 2x2P+E 16A 250V~	221
CF11--	SET STECKDOSE SCHUKO DOPPELT VERTIKAL IP44 2x2P+E 16A 250V~	221
CF12--	SET STECKDOSE SCHUKO + SCHALTER WECHSEL HORIZONTAL IP44 16A + 10AX 250V~	221
CF13--	SET STECKDOSE SCHUKO + SCHALTER WECHSEL VERTIKAL IP44 16A + 10AX 250V~	222
CF14--	SET STECKDOSE SCHUKO DOPPELT HORIZONTAL IP44 2x2P+E 16A 250V~ BV	222
CF15--	SET STECKDOSE SCHUKO DOPPELT VERTIKAL IP44 2P+E 16A 250V~ BV	222
CF16--	SET STECKDOSE SCHUKO + SCHALTER WECHSEL HORIZONTAL IP44 16A + 10AX 250V~ BV	222
CF17--	SET STECKDOSE SCHUKO + SCHALTER WECHSEL VERTIKAL IP44 16A + 10AX 250V~ BV	222
<b>ZUBEHÖR AF</b>		
AF10--	ABZWEIGKASTEN IP44 RN01	223
AF20--	ABZWEIGKASTEN IP55 ND01	223



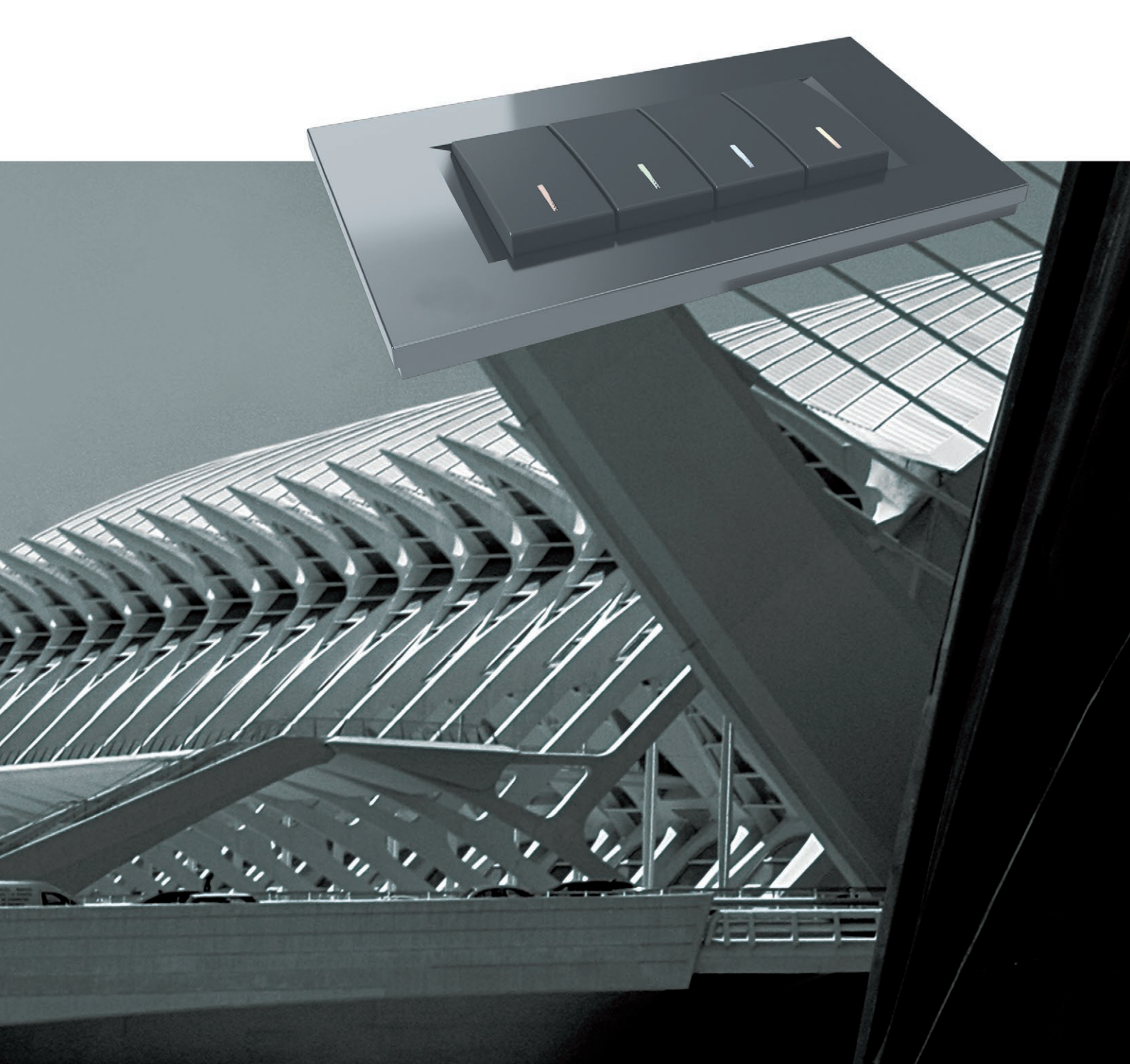

**TEM**

TEM ČATEŽ d.o.o.  
Čatež 13, 8212 VELIKA LOKA  
SLOVENIJA  
tem@tem.si  
www.tem.si  
T +386(0)7 348 99 00



DE